

**iNOKSAN**

ENDÜSTRİYEL  
*Arutfacta*  
ÇÖZÜM  
ORTAĞINIZ

ÜRÜN KATALOĐU  
PRODUCT CATALOGUE

**iNOKSAN**



## Vehbi Varlık

İnoksan A.Ş.  
Yönetim Kurulu Başkanı  
Chairman



### Değerli İş Ortaklarımız,

1980 yılında merdiven altı bir atölyede başlayan maceramızın, tüm emeklerimizin ve çalışmalarımızın sonucunda doğan markamız İnoksan'ı bugün uluslararası platformlarda yabancı markalar ile rekabet ederken görmek bizler için en büyük gurur. 43 yılı geride bıraktığımız bu serüvende, daha nice başarılarla imza atacağımıza olan inancım tam.

Uzun yıllardır bu heyecan ve tutkuyla başarılı işler çıkarmaya devam ediyor ve İnoksan markamızı yurt içinde ve yurt dışında gerçekleştirdiğimiz projelerle en iyi şekilde temsil ediyoruz. Sektörde 43 yılı deviren marka sayısı oldukça az. Aile şirketlerinin ortalama ömrünü 25 yıl olduğu bir iş dünyasında biz bugün 43. Yılımızı kutluyoruz. Önemli olan bundan sonraki süreçte de bunu sürdürülebilir kılmak.

Ekonomi Bakanlığı destekli markalaşma programı olan Turquality'nin içerisindeyiz. Biz buradaki güzel oluşuma Milli Takım diyoruz. Aynı zamanda sektörümüzde tescilli Ar-Ge Merkezi olan şirketlerden biri olmanın gururunu yaşıyoruz. Gerçekleştirdiğimiz yepyeni yatırımlarla, üretim yöntemlerindeki yeniliklerle, sonuçlarımızı iyileştirmeye, dünyadaki gelişmelere ayak uydurmaya ve önümüzdeki süreçte ihracat yaptığımız ülkelerin sayısını ve yurtdışı satış oranlarımızı artırmaya da kararlıyız. Ana mutfaklardaki proje misyonumuzu tamamladık ve kendimizi tüm dünyaya ispatladık. Bundan sonra daha çok ürünlerimizle markalaşmak istiyoruz.

Geride bıraktığımız 43 yılda; kısa ya da uzun süreler için bu ailenin bir parçası olan, başarı hedeflerimize ve ideallerimize inanan, fikriyle, emeğiyle bize katkı sağlayan, neşemize, hüznümüze ortak olan herkese buradan teşekkür ediyorum. Sonraki süreçte de İnoksan'a inanan ve değerlerine sahip çıkarak başarılarımıza katkıda bulunan siz kıymetli yol arkadaşlarımla bu güzel hikayede daha nice güzel günler göreceğiz.

Hepinizi sevgi ve saygılarımla selamlıyorum...



### Esteemed Business Partners,

Our brand Inoksan was born as a result of our adventure and all our efforts and works, which started in 1980 in a small workshop. It is our greatest pride to see Inoksan competing with foreign brands on international platforms today. In the 43rd anniversary of this adventure, I am confident that we will achieve many more accomplishments.

With this excitement and passion for many years, we have been continuing for new achievements and we represent our Inoksan brand in the best way with our domestic and international projects. In our industry, there are only a few companies celebrating its 43rd anniversary. We celebrate our 43rd anniversary in a business world where the average life of family businesses is 25 years. The important thing is to make it sustainable in the future.

We take part in Turquality, a branding program supported by the Ministry of Trade. We call this beautiful formation the National Team. We are also proud to be one of the companies that have a registered R&D Center in our industry. With our new investments and innovations in production methods, we are determined to improve our results and keep up with the developments in the world, and also to increase the number of countries we export to and our overseas sales rates in the upcoming period. We have completed our project mission in the main kitchens and proved ourselves to the whole world. Now, we want to boost our brand more with our products.

I would like to thank everyone who has been a part of this family for short or long periods, believed in our success goals and ideals, contributed to us with their ideas, labor, and shared our joy and sadness in 43 years we left behind. We hope to see many better days in this beautiful story in the future with you, my distinguished companions, who believe in Inoksan and contribute to our success by preserving their values.

I greet you all with love and respect.

**Vehbi Varlık**  
İnoksan A.Ş.  
Yönetim Kurulu Başkanı  
Chairman of Inoksan Board of Directors



2005

**"ÜSTÜNLÜK ÇALIŞMASI" (EFQM) ÖDÜLÜ ALINDI**  
İNOKSDESİNG, AKADEMI İNOKSAN KURULDU İnoksan ailesini yeni üyelerle genişledik. (EFQM) KARARLILIK ÖDÜLÜ ALINDI 16. Ulusal Kalite Kongresinde EFQM "Mükemmellikte Kararlılık" Ödülünü aldık.

2007

**EFQM MÜKEMMELLİKTE YETKİNLİK 5 YILDIZ ÖDÜLÜ ALINDI**

17. Ulusal Kalite Kongresinde "EFQM Mükemmellikte Yetkinlikte 5 Yıldız" belgesini aldık. TÜRKİYEDE BİR İLK OLAN PALETLİ BULAŞIK MAKİNESİ ÜRETİMİ VE İHRACATI GERÇEKLEŞTİRİLDİ Ürettiğimiz özgün ürünleri uluslararası pazara sunduk. YENİ NESİL CNC VE LASER KESME MAKİNELERİ YATIRIMI YAPILDI. Üretim yeteneğimizi arttıran makinelere yatırım yaptık.

2009

Satış ekibi ve satış kanalları yeniden yapılandırıldı.

2011

TURQUALITY projesi kapsamında MARKA desteği almaya hak kazandı.

2013

Türkiye'nin ilk yerli kombi firm ailesi İnosmart, sektörümüze kazandırıldı. Amerika bayimizin açılmasıyla ihracat hedefimizi büyüttük.

2015

İnoksan Turquality markası olmaya hak kazanmıştır.

2017

**BİLGİ SİSTEMLERİMİZİ GELİŞTİREREK SAP ERP SİSTEMİNE GEÇTİK**

Toplamda yaklaşık 2.000.000 o'luk yeni yatırım ile üretim gücümüze güç kattık.

2020

Amerika UL belgesi alındı.  
5 Kıtada 100 ü aşkın ülkeye ihracat yaptık.

2021

2022

**TÜM CİHAZLARIMIZIN CE BELGELERİ ALINDI**

Tüm cihazlarımızın Avrupa normlarına uygunluğunu belgeledik. 25. YILIMIZI KUTLADIK Gelişerek büyüyen İNOKSAN 'ın 25.yılımı kutladık. YENİ TESİSİMİZİN TEMELİ ATILDI Büyüyen hizmetimize paralel olarak yeni tesisimizin temelini attık.

2006

**HIGH QUALITY SERVİS SİSTEMLERİ ÜRETİMİ BAŞLADI (TAMAMI AVRUPA İÇİN)**

2008

**ÜRETİMİ YÖNETİM VE DAĞITIM KANALLARINDA YENİ OLUŞUMLAR YAPILDI**

Daha iyi hizmet için yönetim ve dağıtım organlarında yeniden yapılandırma çalışmalarını yaptık.

2010

Bayilik yapılandırmasıyla bünyesine yeni lokasyonlar katan İnoksan, sosyal sorumluluk projesi E Tipi Mutfağı ile Altın Pusula Jüri Özel Ödülünü aldı.

2012

Yönetim kurulu başkanımız Vehbi Varlık İnoksan'ın tek hissedarı oldu. Dünya devleri GRAM COMMERCIAL ve LANCER ile teknik işbirlikleri başladı.

2014

Sektörde ilk profesyonel Çağrı Merkezini kurduk.

Yurt içinde 40 yurt dışında yaklaşık 60 bayiiye ulaştık.

Makine parkuru genişletildi. 1000'li adetlerde ürün üretimleri başladı.

2016

İnoksan Ar-Ge merkezi kuruldu.

2018



2020

Çin COC Uygunluk belgesi alındı.  
Özbekistan Taşkent'te İnoksan Showroom açıldı.

# CHRONOLOGY

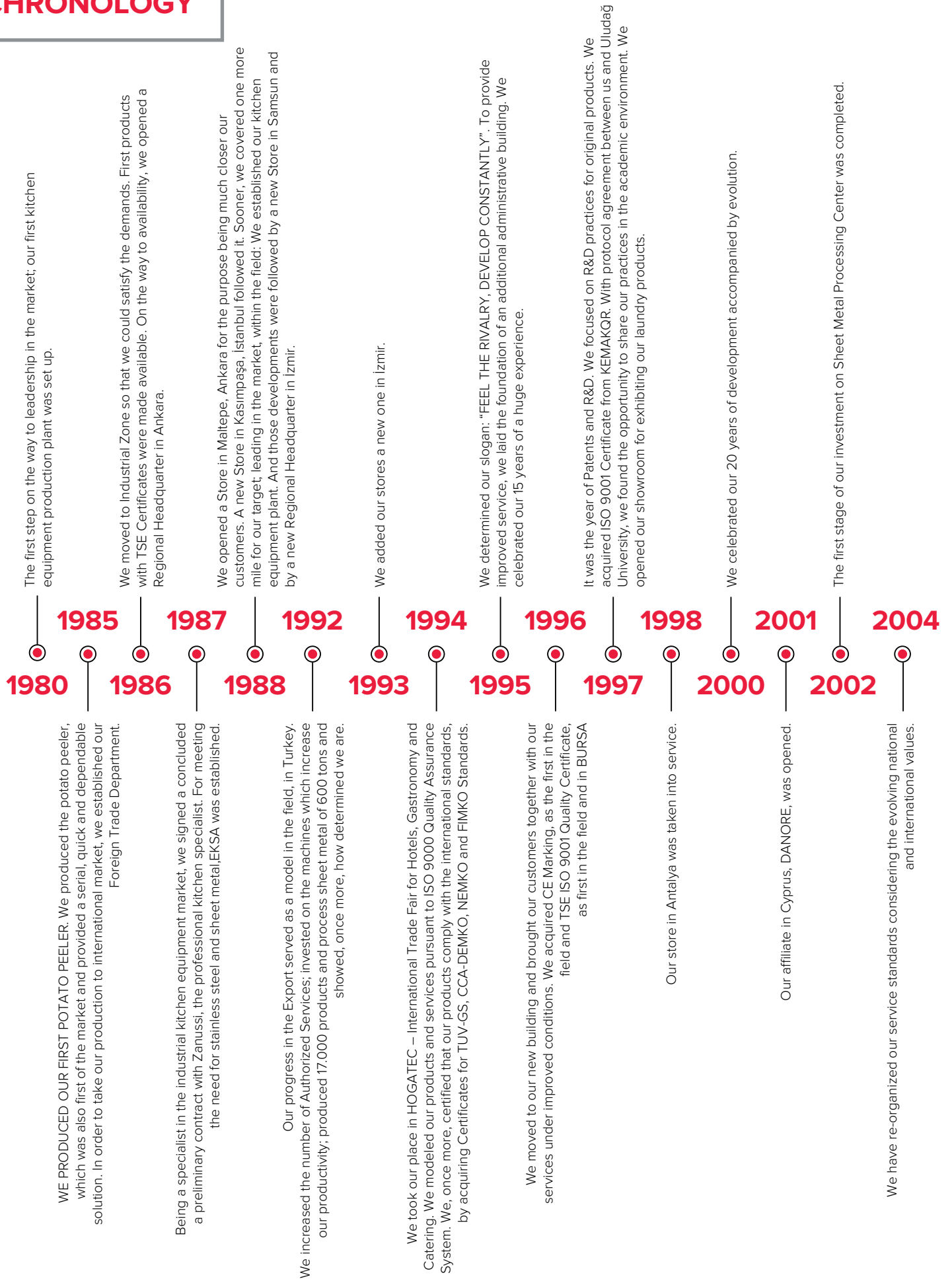

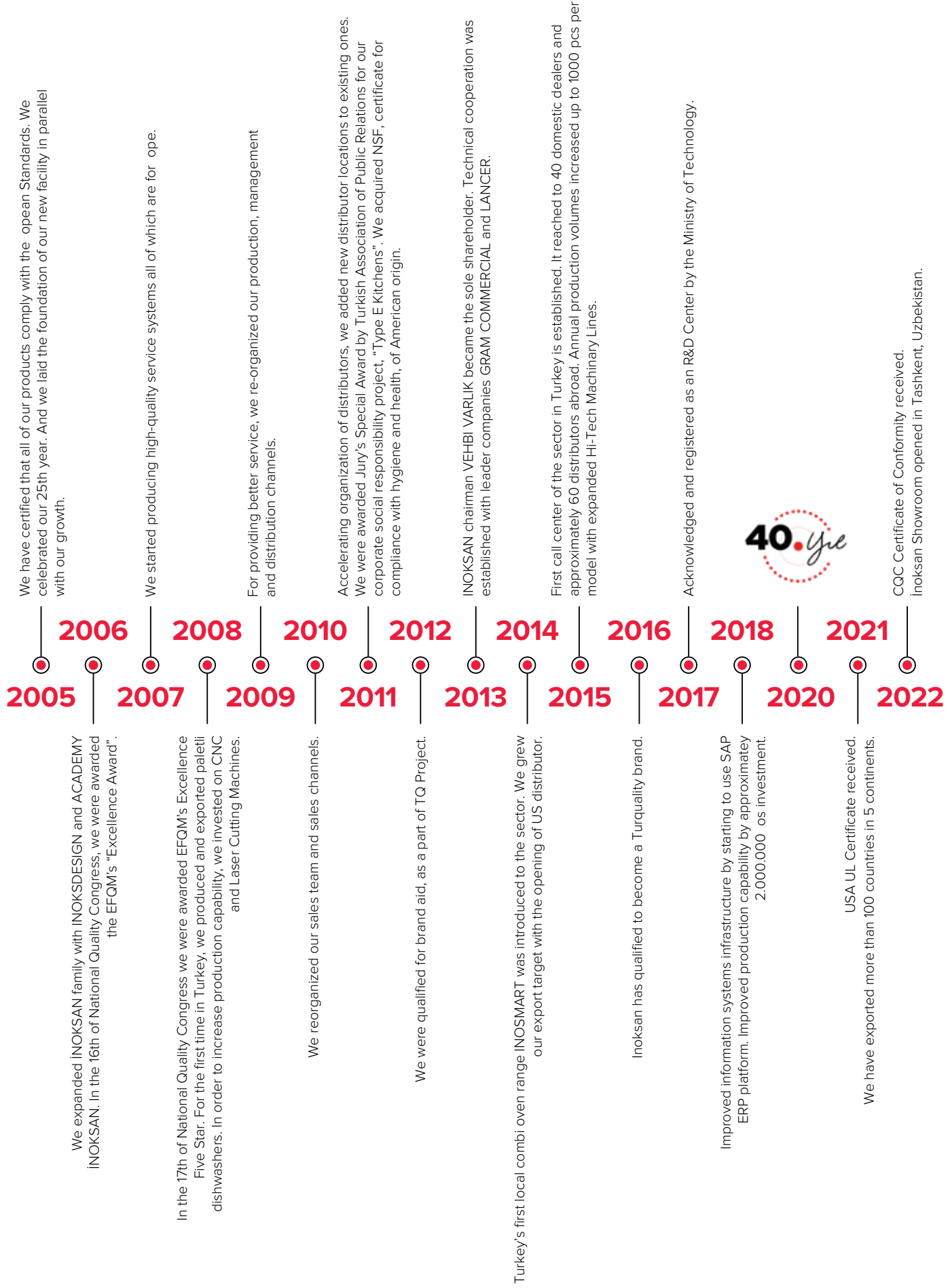

# KURUMSAL DEĞERLERİMİZ

## OUR CORPORATE VALUES



### Yenilikte Öncülük Leader In Innovation

Ulusal ve uluslararası pazarda etkinliğimizi artırmak için yeni yöntemler geliştirir, fırsatları değerlendirir, problemleri çözer ve mükemmeli yakalamak için çalışırız.

We develop new methods, use opportunities, solve problems and aim to achieve excellence in order to increase our strength in the national and international markets.



### Sektörün Lokomotifini The driving force of the sector

Yenilikçi ürün, hizmet ve uygulamalarla yol açarken, sürekli gelişim ilkesiyle öncülük rolü üstleniriz.

We hold the pioneer position with our principle of continuous development, while leading up with innovative products, service and applications



### Değişime Açık, Katılımcı Open to change, contributing

Yeni fikirleri dener, değişimlere uyum gösterir, tecrübe ve bilgi birikiminden yararlanırız.

We try new ideas, accommodate with changes and make use of experience and knowledge.



### Kaliteli Ürün Kaliteli Hizmet Quality product, quality service

Toplam kalite anlayışıyla müşterilerimize en iyi koşullarda en iyi ürün ve hizmetleri sunarız.

With our sense of total quality we provide the best product and service on best conditions.



### Güvenilirlik Reliable

Söylediklerimizde ve yaptıklarımızda tutarlı davranırız. Tüm faaliyetlerimizin odağında karşılıklı memnuniyet vardır.

We develop new methods, use opportunities, solve problems and aim to achieve excellence in order to increase our strength in the national and international markets.



### Sosyal Sorumluluk Sahibi Holding Social Responsibility

İnanırlılık, dürüstlük ve iyi iletişim yeteneklerimizle, sosyal sorumluluk bilinci kapsamında topluma değer katmaya çalışırız.

We aim to add value to the society in respect with a sense of social responsibility with our abilities of reliability, honesty and good communication.



### Sürekli İyileştirme Continuous improvement

Müşteri mutluluğu esastan hareketle, araştırma geliştirmeye önem verir, ileri teknolojileri izleyip uygulayarak, çalışanlarımızı eğiterek, bireysel ve ekip çalışmalarını destekleyerek hedeflerimizi sürekli iyileştiririz.

From the point of the principle of customer satisfaction, we care about research and development, and improve our targets by following up and applying new technologies, training our employees and supporting individual and team works.



### Çevreye Duyarlı Environment-friendly

AR-GE ve üretim politikalarımız maksimum geri dönüşüm felsefesi etrafında oluşturulmuştur. Malzeme ve hammadde seçiminde doğa ile dost tercihler birinci önceliğimizdir.

Our R&D and production policies are consisted on the recycling philosophy. Making nature-friendly preferences during the selection of material and raw material are our first priority.



## İNOKSAN KURUM MİSYONU



### OUR MISSION

**Endüstriyel mutfak sektöründe, müşterinin bugünkü ve gelecekteki beklentilerine en uygun, ürün, proje ve hizmeti sunmak.**

Offering products, projects and services most suitable to current and future expectations of customers in industrial kitchen sector.



## POLİTİKAMIZ



### OUR POLICY

**“Vizyonumuzdan aldığımız güçle dün olduğu gibi bugün de dünya kuruluşu olmak yolunda hızla ilerliyoruz. Bu yolculukta İnoksan yönetim sisteminin sürekli iyileştirilmesi bizi bugün ve gelecekteki hedeflerimize taşıyacak en önemli araçtır. Misyonumuzun sorumluluğunda değerlerimizden ödün vermeden her gün daha verimli daha güvenli daha ekolojik ve kullanıcı dostu mutfaklar gerçekleştirmektir.”**

“With the strength we draw from our vision, we rapidly advance on the path of becoming a world organization today as it was yesterday. Constant improvement of Inoksan management system in this journey is the most important vehicle that would carry us to our current and future targets. Creating more efficient, more reliable, more ecological and user-friendly kitchens every day without compromising our values, conscious of the responsibility of our mission.



## İNOKSAN KURUM VİZYONU



### OUR VISION

**Dünya markası olmak.**  
Becoming a world brand.

# İÇİNDEKİLER

## CONTENTS



GAZLI



ELEKTRİKLİ



154

SERVİS HATLARI  
SERVICE LINES



GASTROLINE SERVİS HATTI 154  
GASTROLINE SERVICE LINE  
DROP-IN SOĞUK HAVUZ FANLI 164

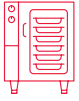

13

PIŞIRICI CİHAZLAR  
VE EKİPMANLAR

COOKING  
APPLIANCES  
AND EQUIPMENTS



MODÜLER PİŞİRİCİLER  
MODULAR COOKERS

PERFECT 900 14  
PERFECT 700 30  
PERFECT 900 S 44  
PERFECT 700 S 54

FIRINLAR VE EKİPMANLARI  
OVENS AND EQUIPMENTS

İNOSMART STEAM 70  
İNOSMART CONVECT 75  
İNOSMART EASYCOOK 81  
PIZZA FIRINLARI 82  
PASTRY AND PIZZA OVENS  
MİKRODALGA FIRIN 88  
MICROWAVE OVENS

SETÜSTÜ PİŞİRİCİLER  
WORKTOP UNITS

DÖNER OCAKLARI 90  
DONER KEBAB MACHINES  
DİĞER SETÜSTÜ PİŞİRİCİLER 94  
OTHER COOKING UNITS

DİĞER PİŞİRİCİLER  
OTHER COOKING

KUZİNELER / RANGES 102  
YER OCAKLARI / STOVES 104



107

BULAŞIK YIKAMA  
MAKİNELERİ  
DISHWASHERS



BULAŞIK YIKAMA MAKİNELERİ 108  
DISHWASHERS  
BULAŞIK YIKAMA MAKİNESİ  
EKİPMANLARI 126  
EQUIPMENTS FOR  
DISHWASHERS

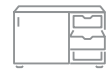

135

TEZGAHLAR  
WORK TABLES



STANDART TEZGAHLAR VE 136  
TREND SERİ TEZGAHLAR  
STANDAD TABLES  
EVİYELİ TEZGAHLAR 148  
SINK UNITS

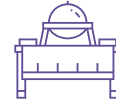

173

İNOKSDESİGN



İNOKSDESİGN AÇIK BÜFE VE 174  
SERVİS HATLARI  
OPEN BUFFETS AND SERVICE  
LINES



193

HAZIRLAMA  
MAKİNELERİ  
PREPERATION  
UNITS



SEBZE VE HAMUR HAZIRLAMA 194  
MAKİNELERİ  
VEGETABLE, DOUGH  
PREPARATION UNITS  
AND BAR EQUIPMENTS



## 203



MUTFAK ARABALARI 204  
TROLLEYS



## 213



DAVLUMBAZLAR 214  
HOODS  
YER IZGARALARI 220  
FLOOR GRIDS  
YAĞ TUTUCULAR  
OIL RETAINERS



## 243



STANDART 246  
SOĞUTUCULAR  
STANDARD COOLING  
EQUIPMENTS  
PREMIUM SERİ 256  
SOĞUTUCULAR  
PREMIUM COOLING  
EQUIPMENTS



## 227



İSTİF RAFLARI 228  
STORAGE SHELVES  
MUTFAK DOLAPLARI 236  
KITCHEN CABINETS  
ASKI SİSTEMLERİ 238  
SUSPENSION SYSTEMS  
RAFLAR 240  
SHELVES



## 275



BUZ MAKİNELERİ / ICEMATIC 277  
BULAŞIK YIKAMA MAKİNELERİ 284  
DISHWASHING MACHINES  
KONVEYÖRLÜ BULAŞIK YIKAMA  
MAKİNESİ 287  
RACK TYPE WASHING MACHINE  
GIDA DİLİMLEME MAKİNELERİ 288  
SLICERS  
HAZIRLAMA MAKİNELERİ 290  
PREPARATION MACHINES  
HAMUR AÇMA MAKİNELERİ 300  
DOUGH SHEETERS  
SEBZE YIKAMA MAKİNELERİ 291  
/MIKSERLER  
VEGETABLE WASHING  
MACHINES / MIXERS  
SEBZE DOĞRAMA MAKİNELERİ 291  
VEGETABLE PROCESSORS  
EL BLENDERLERİ 293  
DISK KOLEKSİYONU 296  
DISC COLLECTION  
BUHAR KONVEKSİYONLU FIRINLAR 298  
COMBI STEAMERS  
İNDÜKSİYONLU PIŞİRİCİLER 300  
INDUCTION COOKER  
MODÜLER FIRINLAR 301  
MODULAR OVENS  
NARENÇİYE SIKMA MAKİNELERİ 305  
CITRUS JUICERS  
FİLTRE KAĞVE MAKİNELERİ 306  
FILTER COFFEE MACHINES  
ESPRESSO KAĞVE MAKİNELERİ 307  
ESPRESSO COFFEE MACHINES



## 313



ÇAMAŞIRHANE 315  
MAKİNELERİ VE  
EKİPMANLARI  
LAUNDRY EQUIPMENT  
ÇAMAŞIR KURUTMA 320  
MAKİNELERİ  
LAUNDRY DRYING  
MACHINES  
ÜTÜLER / INDUSTRIAL 324  
IRONERS  
KURU TEMİZLEME 330  
MAKİNELERİ  
DRY CLEANING  
MACHINES



## 334



HİJYEN / MEDİKAL 334  
HYGIENE / MEDICAL





**Piřirici Cihazlar  
ve Ekipmanları**

Cooking Appliances  
and Equipment

# PERFECT 900

Modüler Pişiriciler  
Modular Cookers



- Tüm cihazlar modüler olup, müşteri ihtiyaçlarına göre kombinasyonlar oluşturulabilir.
- Tüm modeller aralarında kirin birikmesini önleyecek şekilde tasarlanmıştır.
- Gazlı modeller alev emniyet sistemli, elektrikli modeller ise emniyet termostatlıdır.
- Tüm cihazlar ergonomik kullanım tarzı düşünülerek tasarlanmıştır.
- Gazlı ve elektrikli tüm modeller CE şartlarına uygundur.
- Cihazların hat şeklinde birbirlerine bağlanmalarına imkan verecek şekilde tasarlanmıştır.

- The perfect 900 Serie is completely modular for limitless combinations and has been specially designed for our customer needs.
- All devices and equipment are manufactured from AISI304 grade 18/8 Cr/Ni stainless steel.
- Connection between side to side models has been specially designed to avoid dirtiness.
- Gas and electric versions available all equipped with safety pilots and thermocouple/flame failure device.
- Esthetic and ergonomic buttons and panels.
- Easy cleaning thanks to rounded design.
- Highest international standards are achieved.

**INO-9KE10**

KUZİNE / COOKER

**INO-9KE20**

KUZİNE / COOKER

**INO-9KE30**

KUZİNE / COOKER



MODEL	MODÜL	GENİŞLİK	DERİNLİK	YÜKSEKLİK	ISI KAPASİTESİ	ELEKTRİK GİRİŞİ
	MODULE	WIDTH	DEPTH	HEIGHT	HEAT CAP.	ELECTRIC INLET
		mm	mm	mm	kW	V
INO-9KE10	1/2	400	900	850	8	380 - 400 V / 3N 50-60 Hz
INO-9KE20	1	800	900	850	16	380 - 400 V / 3N 50-60 Hz
INO-9KE30	1	1200	900	850	24	380 - 400 V / 3N 50-60 Hz

**INO-9KE23**

 KUZİNE / FIRINLI  
COOKER WITH OVEN

**INO-9KE33**

 KUZİNE / COOKER  
1 MOD. FIRIN + 1/2 MOD. DOLAP  
1 MOD. OVEN + 1/2 MOD. CLIPBOARD

**INO-9KE33F**

 KUZİNE / COOKER  
1,5 MOD. FIRIN  
1,5 MOD. OVEN

MODEL	MODÜL	GENİŞLİK	DERİNLİK	YÜKSEKLİK	ISI KAPASİTESİ	ELEKTRİK GİRİŞİ
	MODULE	WIDTH	DEPTH	HEIGHT	HEAT CAP.	ELECTRIC INLET
		mm	mm	mm	kW	V
INO-9KE23	1	800	900	850	22	380 - 400 V / 3N 50-60 Hz
INO-9KE33	1,5	1200	900	850	30	380 - 400 V / 3N 50-60 Hz
INO-9KE33F	1,5	1222	937	1006	33	380 - 400 V / 3N 50-60 Hz

**INO-9KE11**

 SERAN CAMLI OCAK  
COOKER WITH CERAMIC GLASS

MODEL	MODÜL	GENİŞLİK	DERİNLİK	YÜKSEKLİK	ISI KAPASİTESİ	ELEKTRİK GİRİŞİ
	MODULE	WIDTH	DEPTH	HEIGHT	HEAT CAP.	ELECTRIC INLET
		mm	mm	mm	kW	V
INO-9KE11	1/2	400	900	850	6	380 - 400 V / 3N 50-60 Hz

**KUZİNE  
COOKER**
**INO-9KG10**

**KUZİNE  
COOKER**
**INO-9KG20**

**KUZİNE /  
KAPALI DÖKÜM  
SOLID TOP COOKER**
**INO-9KG21**

**KUZİNE / FIRINLI  
COOKER WITH OVEN**
**INO-9KG23**

MODEL	MODÜL	GENİŞLİK	DERİNLİK	YÜKSEKLİK	ISI KAPASİTESİ	BRÜLÖR	GAZ GİRİŞİ
	MODULE	WIDTH	DEPTH	HEIGHT	HEAT CAP.	BURNER	GAS INLET
		mm	mm	mm	kW	Ø-Adet / Ø-Adet Ø-Piece / Ø-Piece	Inch
INO-9KG10	1/2	400	900	850	15	Ø100 x 1 ve/ and Ø130 x 1	3/4"
INO-9KG20	1	800	900	850	30	Ø100 x 2 ve/ and Ø130 x 2	3/4"
INO-9KG21	1	800	900	850	9	Ø130 x 1	3/4"
INO-9KG23	1	800	900	850	38,5	Ø100 x 2 ve/ and Ø130 x 2	3/4"

**KUZİNE / COOKER**
**INO-9KG30**

**KUZİNE / COOKER**  
1 MOD. FIRIN + 1/2 MOD. DOLAP  
1 MOD. OVEN + 1/2 MOD. CUPBOARD

**INO-9KG33**

**KUZİNE / COOKER**  
1,5 MOD. FIRIN  
1,5 MOD. OVEN

**INO-9KG33F**

MODEL	MODÜL	GENİŞLİK	DERİNLİK	YÜKSEKLİK	ISI KAPASİTESİ	BRÜLÖR	GAZ GİRİŞİ
	MODULE	WIDTH	DEPTH	HEIGHT	HEAT CAP.	BURNER	GAS INLET
		mm	mm	mm	kW	Ø-Adet / Ø-Adet Ø-Piece / Ø-Piece	Inch
INO-9KG30	1,5	1200	900	850	45	Ø100 x 3 ve Ø130 x 3	3/4"
INO-9KG33	1,5	1200	900	850	53,5	Ø100 x 3 ve Ø130 x 3	3/4"
INO-9KG33F	1,5	1200	900	850	37	Ø100 x 3 ve Ø130 x 3	3/4"

**INO-91E10**

 IZGARA / DÜZ  
GRILL / SMOOTH

**INO-91E11**

 IZGARA / OLUKLU  
GRILL / RIBBED

**INO-91E20**

 IZGARA / DÜZ  
GRILL / SMOOTH

**INO-91E21**

 IZGARA / OLUKLU  
GRILL / RIBBED

MODEL	MODÜL	GENİŞLİK	DERİNLİK	YÜKSEKLİK	ISI KAP.	IZGARA ÖLÇÜSÜ	ELEKTRİK GİRİŞİ
	MODULE	WIDTH	DEPTH	HEIGHT	HEAT CAP.	GRILL SIZE	ELECTRIC INLET
		mm	mm	mm	kW	mm	V
INO-91E10	1/2	400	900	850	6	395 x 660	380 - 400 V / 3N 50-60 Hz
INO-91E11	1/2	400	900	850	6	395 x 660	380 - 400 V / 3N 50-60 Hz
INO-91E20	1	800	900	850	12	795 x 660	380 - 400 V / 3N 50-60 Hz
INO-91E21	1	800	900	850	12	795 x 660	380 - 400 V / 3N 50-60 Hz

**INO-91E22**

 IZGARA / GRILL  
1/2 DÜZ + 1/2 OLUKLU  
/ 1/2 SMOOTH + 1/2 RIBBED

**INO-91E30**

 IZGARA / DÜZ  
GRILL / SMOOTH

**INO-91E31**

 IZGARA / OLUKLU  
GRILL / RIBBED

**INO-91E32**

 1/2 OLUKLU + 1 DÜZ  
1/2 RIBBED + 1 SMOOTH  
IZGARA / DÜZ  
GRILL / SMOOTH

MODEL	MODÜL	GENİŞLİK	DERİNLİK	YÜKSEKLİK	ISI KAP.	IZGARA ÖLÇÜSÜ	ELEKTRİK GİRİŞİ
	MODULE	WIDTH	DEPTH	HEIGHT	HEAT CAP.	GRILL SIZE	ELECTRIC INLET
		mm	mm	mm	kW	mm	V
INO-91E22	1	800	900	850	12	795 x 660	380 - 400 V / 3N 50-60 Hz
INO-91E30	1.5	1200	900	850	18	1194 x 660	380 - 400 V / 3N 50-60 Hz
INO-91E31	1.5	1200	900	850	18	1194 x 660	380 - 400 V / 3N 50-60 Hz
INO-91E32	1.5	1200	900	850	18	1194 x 660	380 - 400 V / 3N 50-60 Hz

**INO-9IG10**

 IZGARA / DÜZ  
GRILL / SMOOTH

**INO-9IG11**

 IZGARA / OLUKLU  
GRILL / RIBBED

**INO-9IG20**

 IZGARA / DÜZ  
GRILL / SMOOTH

MODEL	MODÜL	GENİŞLİK	DERİNLİK	YÜKSEKLİK	ISI KAP.	IZGARA ÖLÇÜSÜ	GAZ GİRİŞİ
	MODULE	WIDTH	DEPTH	HEIGHT	HEAT CAP.	GRILL SIZE	GAS INLET
		mm	mm	mm	kW	mm	Inch
INO-9IG10	1/2	400	900	850	7	395 x 660	3/4"
INO-9IG11	1/2	400	900	850	7	395 x 660	3/4"
INO-9IG20	1	800	900	850	14	795 x 660	3/4"

**INO-9IG21**

 IZGARA / OLUKLU  
GRILL / RIBBED

**INO-9IG22**

 IZGARA / 1/2 DÜZ + 1/2 OLUKLU  
GRILL / 1/2 SMOOTH + 1/2 RIBBED

MODEL	MODÜL	GENİŞLİK	DERİNLİK	YÜKSEKLİK	ISI KAP.	IZGARA ÖLÇÜSÜ	GAZ GİRİŞİ
	MODULE	WIDTH	DEPTH	HEIGHT	HEAT CAP.	GRILL SIZE	GAS INLET
		mm	mm	mm	kW	mm	Inch
INO-9IG21	1	800	900	850	14	795 x 660	3/4"
INO-9IG22	1	800	900	850	14	795 x 660	3/4"

**INO-9IG30**

 IZGARA / DÜZ  
GRILL / SMOOTH

**INO-9IG31**

 IZGARA / OLUKLU  
GRILL / RIBBED

**INO-9IG32**

 IZGARA / OLUKLU DÜZ  
GRILL / RIBBED

MODEL	MODÜL	GENİŞLİK	DERİNLİK	YÜKSEKLİK	ISI KAPASİTESİ	IZGARA ÖLÇÜSÜ	ELEKTRİK GİRİŞİ	GAZ GİRİŞİ
	MODULE	WIDTH	DEPTH	HEIGHT	HEAT CAP.	GRILL SIZE	ELECTRIC INLET	GAS INLET
		mm	mm	mm	kW	mm	V	Inch
INO-9IG30	1.5	1200	900	850	18	1194x660	380-400V / 3N 50-60Hz	3/4"
INO-9IG31	1.5	1200	900	850	18	1194x660	380-400V / 3N 50-60Hz	3/4"
INO-9IG32	1.5	1200	900	850	18	1194x660	380-400V / 3N 50-60Hz	3/4"



**INO-9LG10**

IZGARA / LAVATAŞLI  
GRILL / LAVASTONE



**INO-9LG20**

IZGARA / LAVATAŞLI  
GRILL / LAVASTONE



**INO-9LG30**

IZGARA / LAVATAŞLI  
GRILL / LAVASTONE



MODEL	MODÜL	GENİŞLİK	DERİNLİK	YÜKSEKLİK	ISI KAPASİTESİ	IZGARA ÖLÇÜSÜ	GAZ GİRİŞİ
	MODULE	WIDTH	DEPTH	HEIGHT	HEAT CAP.	GRILL SIZE	GAS INLET
		mm	mm	mm	kW	mm	Inch
INO-9LG10	1/2	400	900	850	10,3	395 x 510	3/4"
INO-9LG20	1	800	900	850	20,6	795 x 510	3/4"
INO-9LG30	1.5	1200	900	850	30,9	1195 x 588	3/4"



**INO-9ZG10**

SULU IZGARA  
GRILL WITH  
WATER SYSTEM



**INO-9ZG20**

SULU IZGARA  
GRILL WITH  
WATER SYSTEM



**INO-9ZG30**

SULU IZGARA  
GRILL WITH  
WATER SYSTEM



MODEL	MODÜL	GENİŞLİK	DERİNLİK	YÜKSEKLİK	ISI KAP.	IZGARA ÖLÇÜSÜ	GAZ GİRİŞİ
	MODULE	WIDTH	DEPTH	HEIGHT	HEAT CAP.	GRILL SIZE	GAS INLET
		mm	mm	mm	kW	mm	Inch
INO-9ZG10	1/2	400	900	850	10,3	395 x 585	3/4"
INO-9ZG20	1	800	900	850	20,6	795 x 585	3/4"
INO-9ZG30	1,5	1200	900	850	30,9	1195 x 585	3/4"



**INO-90G20**

SHOW OCAĞI  
SHOW COOKER



**INO-90G10W**

WOK OCAĞI  
WOK COOKER



MODEL	MODÜL	GENİŞLİK	DERİNLİK	YÜKSEKLİK	ISI KAPASİTESİ	BRÜLÖR	GAZ GİRİŞİ
	MODULE	WIDTH	DEPTH	HEIGHT	HEAT CAP.	BURNER	GAS INLET
		mm	mm	mm	kW	Ø-Adet / Ø-Adet Ø-Piece / Ø-Piece	Inch
INO-90G20	1	800	900	850	20	Ø265 x 1	3/4"
INO-90G10W	1/2	400	900	850	15,5	Ø190 x 1	3/4"

**INO-90E10W**
**İNDÜKSİYONLU WOK OCAK**  
**INDUCTION WOK COOKER**

**INO-90E10I**
**İNDÜKSİYONLU OCAK**  
**INDUCTION COOKER**

**INO-90E20I**
**İNDÜKSİYONLU OCAK**  
**INDUCTION COOKER**

MODEL	MODÜL	GENİŞ.	DERİN.	YÜKSEK.	ISI KAP.	WOK ÇAPI	SERAN CAM ÖLÇÜSÜ	ELEKTRİK GİRİŞİ
	MODULE	WIDTH	DEPTH	HEIGHT	HEAT CAP.	WOK DIAMETER	CERAMIC GLASS SIZE	ELECTRIC INLET
		mm	mm	mm	kW	mm	mm	V
INO-90E10W	1/2	400	900	850	5	Ø300	-	380 - 400 V / 3N 50-60 Hz
INO-90E10I	1/2	400	900	850	10	-	720 x 360	380 - 400 V / 3N 50-60 Hz
INO-90E20I	1	800	900	850	20	-	2 x 720 x 360	380 - 400 V / 3N 50-60 Hz

**INO-9BE10**
**SOS BENMARI**  
**BAIN MARIE**

**INO-9BE20**
**SOS BENMARI**  
**BAIN MARIE**

MODEL	MODÜL	GENİŞLİK	DERİNLİK	YÜKSEKLİK	ISI KAPASİTESİ	ELEKTRİK GİRİŞİ
	MODULE	WIDTH	DEPTH	HEIGHT	HEAT CAP.	ELECTRIC INLET
		mm	mm	mm	kW	V
INO-9BE10	1/2	400	900	850	1,5	220 - 230 V / 50-60 Hz
INO-9BE20	1	800	900	850	3	220 - 230 V / 50-60 Hz

**INO-9HE10**

 PATATES DİNLENDİRME  
FRENCH FRIES WARMER

**INO-9FE10-S**

 FRİTÖZ  
DEEP FAT FRYER

**INO-9FE20-S**

 FRİTÖZ  
DEEP FAT FRYER

MODEL	MODÜL	GENİŞLİK	DERİNLİK	YÜKSEKLİK	ISI KAPASİTESİ	KAPASİTE	ELEKTRİK GİRİŞİ
	MODULE	WIDTH	DEPTH	HEIGHT	HEAT CAP.	CAPACITY	ELECTRIC INLET
		mm	mm	mm	kW	mm	V
INO-9HE10	1/2	400	900	850	1	GN 1/1 x 100	220 - 230 V / 1N 50-60 Hz
INO-9FE10-S	1/2	400	900	850	16,5	26	380 - 400 V / 3N 50-60 Hz
INO-9FE20-S	1/2	400	900	850	33	26+26	380 - 400 V / 3N 50-60 Hz

**INO-9FE10**

 FRİTÖZ  
FRYER

**INO-9FE20**

 FRİTÖZ  
FRYER

MODEL	MODÜL	GENİŞLİK	DERİNLİK	YÜKSEKLİK	ISI KAPASİTESİ	YAĞ KAPASİTESİ	ELEKTRİK GİRİŞİ
	MODULE	WIDTH	DEPTH	HEIGHT	HEAT CAP.	OIL CAPACITY	ELECTRIC INLET
		mm	mm	mm	kW	Lt	V
INO-9FE10	1/2	400	900	850	18	26	380 - 400 V / 3N 50-60 Hz
INO-9FE20	1	800	900	850	36	26+26	380 - 400 V / 3N 50-60 Hz

**INO-9FG10**
**FRİTÖZ  
FRYER**

**INO-9FG20**
**FRİTÖZ  
FRYER**

MODEL	MODÜL	GENİŞLİK	DERİNLİK	YÜKSEKLİK	ISI KAPASİTESİ	YAĞ KAPASİTESİ	GAZ GİRİŞİ
	MODULE	WIDTH	DEPTH	HEIGHT	HEAT CAP.	OIL CAPACITY	GAS INLET
		mm	mm	mm	kW	lt	Inch
INO-9FG10	1/2	400	900	850	14	24	3/4"
INO-9FG20	1	800	900	850	28	24	3/4"

**INO-9ME10**
**MAKARNA HAŞLAMA  
PASTA COOKER**

**INO-9ME20**
**MAKARNA HAŞLAMA  
PASTA COOKER**

MODEL	MODÜL	GENİŞLİK	DERİNLİK	YÜKSEKLİK	ISI KAP.	HAVUZ KAP.	ELEKTRİK GİRİŞİ	SU GİRİŞİ (Soğuk / Sıcak)
	MODULE	WIDTH	DEPTH	HEIGHT	HEAT CAP.	POOL CAPACITY	ELECTRIC INLET	WATER INLET (Cold/Hot)
		mm	mm	mm	kW	lt	V	Inch
INO-9ME10	1/2	400	900	850	9	20	380 - 400 V / 3N 50-60 Hz	3/4"
INO-9ME20	1	800	900	850	18	20 + 20	380 - 400 V / 3N 50-60 Hz	3/4"

**INO-9MG10**
**MAKARNA HAŞLAMA  
PASTA COOKER**

**INO-9MG20**
**MAKARNA HAŞLAMA  
PASTA COOKER**

MODEL	MODÜL	GENİŞLİK	DERİNLİK	YÜKSEKLİK	ISI KAPASİTESİ	HAVUZ KAPASİTESİ	GAZ GİRİŞİ	SU GİRİŞİ (Soğuk / Sıcak)
	MODULE	WIDTH	DEPTH	HEIGHT	HEAT CAP.	POOL CAPACITY	GAS INLET	WATER INLET (Cold/Hot)
		mm	mm	mm	kW	lt	Inch	Inch
INO-9MG10	1/2	400	900	850	10.5	40	3/4"	3/4"
INO-9MG20	1	800	900	850	21	40 + 40	3/4"	3/4"

**INO-9SE10**
**KAYNATMA TENCERESİ  
BOILING PAN**

**INO-9SE15**
**KAYNATMA TENCERESİ  
BOILING PAN**

MODEL	MODÜL	GENİŞLİK	DERİNLİK	YÜKSEKLİK	ISI KAPASİTESİ	HAVUZ KAPASİTESİ	ELEKTRİK GİRİŞİ	SU GİRİŞİ (Soğuk/Sıcak)
	MODULE	WIDTH	DEPTH	HEIGHT	HEAT CAP.	POOL CAPACITY	ELECTRIC INLET	WATER INLET (Cold/Hot)
		mm	mm	mm	kW	Lt	V	Inch
INO-9SE10	1	800	900	850	12	100	380-400 V/3N50-60 Hz	3/4"
INO-9SE15	1	800	900	850	16	150	380-400 V/3N50-60 Hz	3/4"

**INO-9SG10**
**KAYNATMA TENCERESİ  
BOILING PAN**

**INO-9SG15**
**KAYNATMA TENCERESİ  
BOILING PAN**

**INO-9RG25**
**KAYNATMA TENCERESİ  
BOILING PAN**

MODEL	MODÜL	GENİŞLİK	DERİNLİK	YÜKSEKLİK	ISI KAPASİTESİ	HAVUZ KAPASİTESİ	GAZ GİRİŞİ	SU GİRİŞİ (Soğuk/Sıcak)
	MODULE	WIDTH	DEPTH	HEIGHT	HEAT CAP.	POOL CAPACITY	GAS INLET	WATER INLET (Cold/Hot)
		mm	mm	mm	kW	Lt	Inch	Inch
INO-9SG10	1	800	900	850	22	100	3/4"	3/4"
INO-9SG15	1	800	900	850	22	150	3/4"	3/4"
INO-9RG25	1,5	1200	900	850	36	250	3/4"	3/4"

**INO-9DE08**

 DEVRİLİR TAVA  
TILTING BRATT PAN

**INO-9DE12**

 DEVRİLİR TAVA  
TILTING BRATT PAN

**INO-9DG08**

 DEVRİLİR TAVA  
TILTING BRATT PAN

**INO-9DG12**

 DEVRİLİR TAVA  
TILTING BRATT PAN

MODEL	MODÜL	GENİŞLİK	DERİNLİK	YÜKSEKLİK	ISI KAP.	HAVUZ KAP.	ELEKTRİK GİRİŞİ	GAZ GİRİŞİ	SU GİRİŞİ (Soğuk/Sıcak)
	MODULE	WIDTH	DEPTH	HEIGHT	HEAT CAP.	POOL CAP.	ELECTRIC INLET	GAS INLET	WATER INLET (Cold/Hot)
		mm	mm	mm	kW	Lt	V	Inch	Inch
INO-9DE08	1	800	900	850	12	80	380 - 400 V / 3N50-60 Hz	-	3/4"
INO-9DE12	1,5	1200	900	850	20	120	380 - 400 V / 3N50-60 Hz	-	3/4"
INO-9DG08	1	800	900	850	21	80	230 V / 1N50-60 Hz	3/4"	3/4"
INO-9DG12	1,5	1200	900	850	30	120	230 V / 1N50-60 Hz	3/4"	3/4"

**INO-9DE08T**

 MOTORLU  
DEVRİLİR TAVA  
AUTOMATIC TILTING BRATT PAN

**INO-9DE12T**

 MOTORLU  
DEVRİLİR TAVA  
AUTOMATIC TILTING BRATT PAN

**INO-9DG08T**

 MOTORLU  
DEVRİLİR TAVA  
AUTOMATIC TILTING BRATT PAN

**INO-9DG12T**

 MOTORLU  
DEVRİLİR TAVA  
AUTOMATIC TILTING BRATT PAN

MODEL	MODÜL	GENİŞLİK	DERİNLİK	YÜKSEKLİK	ISI KAP.	HAVUZ KAP.	ELEKTRİK GİRİŞİ	GAZ GİRİŞİ	SU GİRİŞİ (Soğuk/Sıcak)
	MODULE	WIDTH	DEPTH	HEIGHT	HEAT CAP.	POOL CAP.	ELECTRIC INLET	GAS INLET	WATER INLET (Cold/Hot)
		mm	mm	mm	kW	Lt	V	Inch	Inch
INO-9DE08T	1	800	900	850	12	80	380 - 400 V / 3N50-60 Hz	-	3/4"
INO-9DE12T	1	1200	900	850	20	120	380 - 400 V / 3N50-60 Hz	-	3/4"
INO-9DG08T	1	800	900	850	21	80	230 V / 1N50-60 Hz	3/4"	3/4"
INO-9DG12T	1	1200	900	850	30	120	230 V / 1N50-60 Hz	3/4"	3/4"



**INO-9TN05**

ARA TEZGAH  
NEUTRAL TABLE



**INO-9TN10**

ARA TEZGAH  
NEUTRAL TABLE



**INO-9TC10**

ARA TEZGAH / ÇEKMECELİ  
NEUTRAL TABLE / DRAWER



MODEL	MODÜL	GENİŞLİK	DERİNLİK	YÜKSEKLİK
	MODULE	WIDTH	DEPTH	HEIGHT
		mm	mm	mm
INO-9TN05	1/4	200	900	850
INO-9TN10	1/2	400	900	850
INO-9TC10	1/2	400	900	850



**INO-9TE10**

ARA TEZGAH / EVYELİ  
NEUTRAL TABLE / SINK



**INO-9TN20**

ARA TEZGAH  
NEUTRAL TABLE



**INO-9TC20**

ARA TEZGAH / ÇEKMECELİ  
NEUTRAL TABLE / DRAWER



MODEL	MODÜL	GENİŞLİK	DERİNLİK	YÜKSEKLİK
	MODULE	WIDTH	DEPTH	HEIGHT
		mm	mm	mm
INO-9TE10	1/2	400	900	850
INO-9TN20	1	800	900	850
INO-9TC20	1	800	900	850

Batarya standart ürün fiyatına dahil değildir.

Tap not included the price.



**INO-9TN10C**

ARA TEZGAH / ÇEKMECELİ DOLAPLI  
NEUTRAL TABLE / DRAWER



**INO-9TC10C**

ARA TEZGAH / ÇEKMECELİ ÖN PANELLİ VE DOLAPLI  
NEUTRAL TABLE / DRAWER

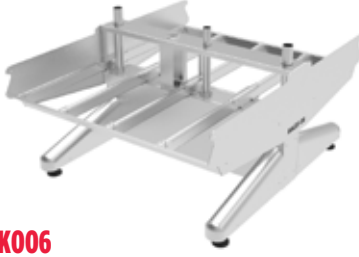

MODEL	MODÜL	GENİŞLİK	DERİNLİK	YÜKSEKLİK
	MODULE	WIDTH	DEPTH	HEIGHT
		mm	mm	mm
INO-9TN10C	1/2	400	900	850
INO-9TC10C	1/2	400	900	850

**INO-9GK006**
**ALT KAİDE SİSTEMİ  
CANTILEVER SYSTEM**

**INO-9GR006**
**ÜST RAF SİSTEMİ  
UPPER SHELF SYSTEM**

MODEL	MODÜL
	MODULE

INO-9GK006	3
INO-9GK007	3,5
INO-9GK008	4

MODEL	MODÜL
	MODULE

INO-9GR006	3
INO-9GR007	3,5
INO-9GR008	4

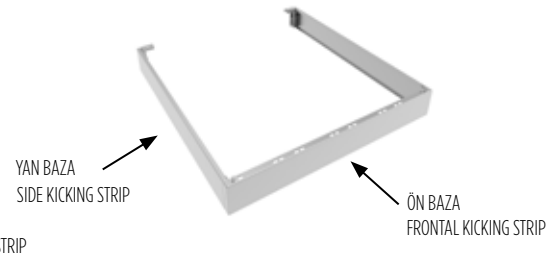
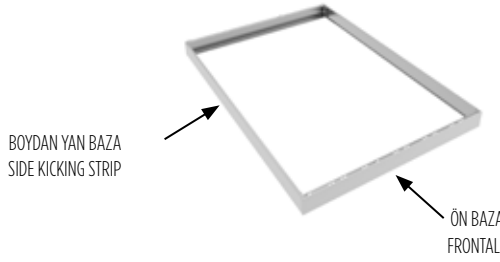
**INO-X9**

**ÖN BAZA / BOYDAN YAN BAZA / YAN BAZA  
FRONTAL KICKING STRIP / SIDE KICKING STRIP**

MODEL	MODÜL
	MODULE

2027000441	200 mm Ön Baza / Frontal Kicking Strip
2027000440	400 mm Ön Baza / Frontal Kicking Strip
2027000450	600 mm Ön Baza / Frontal Kicking Strip
2027000451	800 mm Ön Baza / Frontal Kicking Strip
2027000460	1000 mm Ön Baza / Frontal Kicking Strip
2027000461	1200 mm Ön Baza / Frontal Kicking Strip
2027000470	1400 mm Ön Baza / Frontal Kicking Strip
2027000471	1600 mm Ön Baza / Frontal Kicking Strip
2027000480	1800 mm Ön Baza / Frontal Kicking Strip
2027000481	2000 mm Ön Baza / Frontal Kicking Strip
2027000490	2200 mm Ön Baza / Frontal Kicking Strip
2027000491	2400 mm Ön Baza / Frontal Kicking Strip
2027000420	900 Seri Boydan Yan Baza / Side Kicking Strip
2027000400	900 Seri Yan Baza / Side Kicking Strip



**2028004010**

**CEZVELİK  
COFFEEPOT HOLDER**



**2027301023**

**BENMARİ TABAN SACI  
1/2 MODÜL  
BAIN MARIE BOTTOM SHEET  
1/2 MODULE**



**2027351023**

**BENMARİ TABAN SACI  
1 MODÜL  
BAIN MARIE BOTTOM SHEET  
1 MODULE**



**2027263150**

**MAKARNA  
HAŞLAMA SEPETİ  
(304 KALİTE PASLANMAZ DELİKLİ SAC)  
PASTA COOKER BASKET  
(304 QUALITY  
PERFORATED SHEET)**



**2027263160**

**MAKARNA  
HAŞLAMA SEPETİ  
(316 KALİTE PASLANMAZ DELİKLİ SAC)  
PASTA COOKER BASKET  
(316 QUALITY  
PERFORATED SHEET)**



**2027263170**

**MAKARNA  
HAŞLAMA SEPETİ  
(316 KALİTE PASLANMAZ DELİKLİ SAC)  
PASTA COOKER BASKET  
(316 QUALITY  
PERFORATED SHEET)**



**2027263180**

**MAKARNA  
HAŞLAMA SEPETİ  
(316 KALİTE PASLANMAZ DELİKLİ SAC)  
PASTA COOKER BASKET  
(316 QUALITY  
PERFORATED SHEET)**



**2028204040**

**FRİTÖZ SEPETİ  
FRYER BASKET**



CİHAZ	TEKLİ SEPET	BÜYÜK SEPET
9FE10		
9FE20		
9FG10	2028204040	2028204060
9FG20		

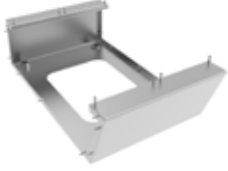

**2028001600**

KÖPRÜ STAND  
SUPPORT FOR  
BRIDGE SYSTEM

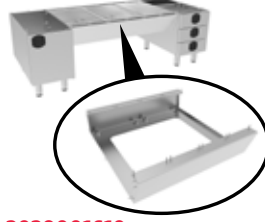

**2028001610**

KÖPRÜ STAND  
SUPPORT FOR  
BRIDGE SYSTEM



**2028001620**

KÖPRÜ STAND  
SUPPORT FOR  
BRIDGE SYSTEM



**2028051060**

PLEYT DESTEK  
SACI KOMPLE  
PLATE SUPPORT KIT



MODEL	MODÜL
	MODULE
2028004010	-
2027301023	1/2
2027351023	1
2027263150	1/2 (1 porsiyon) / 1/2 (1 portion)
2027263160	1/2 (1 porsiyon) / 1/2 (1 portion)
2027263170	1 (2 porsiyon) / 1 (2 portion)
2027263180	2/1 (4 porsiyon) / 2/1 (4 portion)
2028001600	1/2
2028001610	1
2028001620	1,5
2028051060	1



# PERFECT 700

Modüler Pişiriciler  
Modular Cookers



- Tüm cihazlar modüler olup, müşteri ihtiyaçlarına göre kombinasyonlar oluşturulabilir.
- Tamamen 18/8 AISI 304 paslanmaz çelikten üretilmiştir.
- Tüm modeller aralarında kirin birikmesini önleyecek şekilde tasarlanmıştır.
- Gazlı modeller alev emniyet sistemli, elektrikli modeller ise emniyet termostatlıdır.
- Tüm cihazlar ergonomik kullanım tarzı düşünülerek tasarlanmıştır.
- Gazlı ve elektrikli tüm modeller CE şartlarına uygundur.
- Cihazların hat şeklinde birbirlerine bağlanmalarına imkan verecek şekilde tasarlanmıştır.

- The perfect 700 Serie is completely modular for limitless combinations and has been specially designed for our customer needs.
- All devices and equipment are manufactured from AISI304 grade 18/8 Cr/Ni stainless steel.
- Connection between side to side models has been specially designed to avoid dirtiness.
- Gas and electric versions available all equipped with safety pilots and thermocouple/flame failure device.
- Esthetic and ergonomic buttons and panels.
- Easy cleaning thanks to rounded design.
- Highest international standards are achieved.

**INO-7KE10**
**KUZİNE  
COOKER**

**INO-7KE20**
**KUZİNE  
COOKER**

**INO-7KE23**
**KUZİNE / FIRINLI  
COOKER WITH OVEN**

MODEL	MODÜL	GENİŞLİK	DERİNLİK	YÜKSEKLİK	ISI KAPASİTESİ	ELEKTRİK GİRİŞİ
	MODULE	WIDTH	DEPTH	HEIGHT	HEAT CAPACITY	ELECTRIC INLET
		mm	mm	mm	kW	V
INO-7KE10	1/2	400	730	850	4,6	380 - 400 V / 3N 50-60 Hz
INO-7KE20	1	800	730	850	9,2	380 - 400 V / 3N 50-60 Hz
INO-7KE23	1	800	730	850	15,2	380 - 400 V / 3N 50-60 Hz

**INO-7KE30**
**KUZİNE  
COOKER**

**INO-7KE33**
**KUZİNE  
COOKER**  
1 MOD. FIRIN + 1/2 MOD. DOLAP  
1 MOD. OVEN + 1/2 MOD. CUPBOARD

**INO-7KE33F**
**KUZİNE / 15 MOD FIRINLI  
COOKER / 15 MOD OVEN**

MODEL	MODÜL	GENİŞLİK	DERİNLİK	YÜKSEKLİK	ISI KAPASİTESİ	ELEKTRİK GİRİŞİ
	MODULE	WIDTH	DEPTH	HEIGHT	HEAT CAPACITY	ELECTRIC INLET
		mm	mm	mm	kW	V
INO-7KE30	1,5	1200	730	850	13,8	380 - 400 V / 3N 50-60 Hz
INO-7KE33	1,5	1200	730	850	19,8	380 - 400 V / 3N 50-60 Hz
INO-7KE33F	1,5	1200	730	850	21,8	380 - 400 V / 3N 50-60 Hz

**INO-7KE10K**
**KARE PLEYTLÜ KUZİNE  
COOKER WITH  
SQUARE PLATE**

**INO-7KE20K**
**KARE PLEYTLÜ KUZİNE  
COOKER WITH  
SQUARE PLATE**

**INO-7KE23K**
**KARE PLEYTLÜ  
KUZİNE / FIRINLI  
COOKER WITH  
SQUARE PLATE / OVEN**

MODEL	MODÜL	GENİŞLİK	DERİNLİK	YÜKSEKLİK	ISI KAPASİTESİ	ELEKTRİK GİRİŞİ
	MODULE	WIDTH	DEPTH	HEIGHT	HEAT CAPACITY	ELECTRIC INLET
		mm	mm	mm	kW	V
INO-7KE10K	1/2	400	730	850	5,2	380 - 400 V / 3N 50-60 Hz
INO-7KE20K	1	800	730	850	10,4	380 - 400 V / 3N 50-60 Hz
INO-7KE23K	1	800	730	850	16,4	380 - 400 V / 3N 50-60 Hz



SERAN CAMLI OCAK  
COOKER WITH  
CERAMIC GLASS

**INO-7KE11**

SERAN CAMLI OCAK  
COOKER WITH  
CERAMIC GLASS

**INO-7KE21**

SERAN CAMLI OCAK / FIRINLI  
COOKER WITH  
CERAMIC GLASS / OVEN

**INO-7KE24**

MODEL	MODÜL	GENİŞLİK	DERİNLİK	YÜKSEKLİK	ISI KAPASİTESİ	ELEKTRİK GİRİŞİ
	MODULE	WIDTH	DEPTH	HEIGHT	HEAT CAPACITY	ELECTRIC INLET
		mm	mm	mm	kW	V
INO-7KE11	1/2	400	730	850	5	380 - 400 V / 3N 50-60 Hz
INO-7KE21	1	800	730	850	10	380 - 400 V / 3N 50-60 Hz
INO-7KE24	1	800	730	850	16	380 - 400 V / 3N 50-60 Hz

**INO-7KG10**

KUZİNE  
COOKER

**INO-7KG20**

KUZİNE  
COOKER

**INO-7KG21**

KAPALI DÖKÜM OCAK  
SOLID TOP

**INO-7KG23**

KUZİNE / FIRINLI  
COOKER WITH OVEN



MODEL	MODÜL	GENİŞLİK	DERİNLİK	YÜKSEKLİK	ISI KAPASİTESİ	BRÜLÖR	GAZ GİRİŞİ
	MODULE	WIDTH	DEPTH	HEIGHT	HEAT CAPACITY	BURNER	GAS INLET
		mm	mm	mm	kW	Ø-Adet / Ø-Adet Ø-Piece / Ø-Piece	Inch
INO-7KG10	1/2	400	730	850	9,5	Ø75 x 1 ve Ø100 x 1	3/4"
INO-7KG20	1	800	730	850	19	Ø75 x 2 ve Ø100 x 2	3/4"
INO-7KG21	1	800	730	850	9	Ø130 - 1"9	3/4"
INO-7KG23	1	800	730	850	27,5	Ø75 x 2 ve Ø100 x 2	3/4"

**INO-7KG30**

KUZİNE  
COOKER

**INO-7KG33**

KUZİNE  
1 MOD. FIRIN + 1/2 MOD. DOLAP  
COOKER  
1 MOD. OVEN + 1/2 MOD. CUPBOARD

**INO-7KG33F**

KUZİNE / 1,5 MOD FIRINLI  
COOKER / 1,5 MOD. OVEN



MODEL	MODÜL	GENİŞLİK	DERİNLİK	YÜKSEKLİK	ISI KAPASİTESİ	BRÜLÖR	GAZ GİRİŞİ
	MODULE	WIDTH	DEPTH	HEIGHT	HEAT CAPACITY	BURNER	GAS INLET
		mm	mm	mm	kW	Ø-Adet / Ø-Adet Ø-Piece / Ø-Piece	Inch
INO-7KG30	1,5	1200	730	850	28,5	Ø75 x 3 ve Ø100 x 3	3/4"
INO-7KG33	1,5	1200	730	850	37	Ø75 x 3 ve Ø100 x 3	3/4"
INO-7KG33F	1,5	1200	730	850	37	Ø75 x 3 ve Ø100 x 3	3/4"



IZGARA / DÜZ  
GRILL / SMOOTH

**INO-71E11**



IZGARA / OLUKLU  
GRILL / RIBBED

**INO-71E20**



IZGARA / DÜZ  
GRILL / SMOOTH

**INO-71E21**



IZGARA / OLUKLU  
GRILL / RIBBED



MODEL	MODÜL	GENİŞLİK	DERİNLİK	YÜKSEKLİK	ISI KAP.	IZGARA ÖLÇÜSÜ	ELEKTRİK GİRİŞİ
	MODULE	WIDTH	DEPTH	HEIGHT	HEAT CAP.	GRILL SIZE	ELECTRIC INLET
		mm	mm	mm	kW	mm	V
INO-71E10	1/2	400	730	850	4,5	395 x 490	380 - 400 V / 3N 50-60 Hz
INO-71E11	1/2	400	730	850	4,5	395 x 490	380 - 400 V / 3N 50-60 Hz
INO-71E20	1	800	730	850	9	795 x 490	380 - 400 V / 3N 50-60 Hz
INO-71E21	1	800	730	850	9	795 x 490	380 - 400 V / 3N 50-60 Hz



IZGARA / 1/2 DÜZ +  
1/2 OLUKLU  
GRILL / 1/2 SMOOTH +  
1/2 RIBBED

**INO-71E30**



IZGARA / DÜZ  
GRILL / SMOOTH

**INO-71E31**



IZGARA / OLUKLU  
GRILL / RIBBED

**INO-71E32**



2/3 DÜZ 1/3 OLUKLU  
2/3 SMOOTH 1/3 RIBBED  
IZGARA / OLUKLU  
GRILL / RIBBED



MODEL	MODÜL	GENİŞLİK	DERİNLİK	YÜKSEKLİK	ISI KAPASİTESİ	IZGARA ÖLÇÜSÜ	ELEKTRİK GİRİŞİ
	MODULE	WIDTH	DEPTH	HEIGHT	HEAT CAP.	GRILL SIZE	ELECTRIC INLET
		mm	mm	mm	kW	mm	V
INO-71E22	1	800	730	850	9	795 x 490	380 - 400 V / 3N 50-60 Hz
INO-71E30	1.5	1200	730	850	13	1195 x 490	380 - 400 V / 3N 50-60 Hz
INO-71E31	1.5	1222	772	1006	13	1194x489.5	380-400 V
INO-71E32	1.5	1200	730	850	13	1195 x 490	380 - 400 V / 3N 50-60 Hz



IZGARA / DÜZ  
GRILL / SMOOTH

**INO-71G11**



IZGARA / OLUKLU  
GRILL / RIBBED

**INO-71G20**



IZGARA / DÜZ  
GRILL / SMOOTH



MODEL	MODÜL	GENİŞLİK	DERİNLİK	YÜKSEKLİK	ISI KAPASİTESİ	IZGARA ÖLÇÜSÜ	GAZ GİRİŞİ
	MODULE	WIDTH	DEPTH	HEIGHT	HEAT CAP.	GRILL SIZE	GAS INLET
		mm	mm	mm	kW	mm	Inch
INO-71G10	1/2	400	730	850	6	395 x 490	3/4"
INO-71G11	1/2	400	730	850	6	395 x 490	3/4"
INO-71G20	1	800	730	850	12	795 x 490	3/4"

**INO-71G21**  
 IZGARA / OLUKLU  
 GRILL / RIBBED

**INO-71G22**

 IZGARA  
 1/2 DÜZ + 1/2 OLUKLU  
 GRILL  
 1/2 SMOOTH + 1/2 RIBBED

**INO-71G30**

 IZGARA / DÜZ  
 GRILL / SMOOTH

MODEL	MODÜL	GENİŞLİK	DERİNLİK	YÜKSEKLİK	ISI KAPASİTESİ	IZGARA ÖLÇÜSÜ	GAZ GİRİŞİ
	MODULE	WIDTH	DEPTH	HEIGHT	HEAT CAP.	GRILL SIZE	GAS INLET
		mm	mm	mm	kW	mm	Inch
INO-71G21	1	800	730	850	12	795 x 490	3/4"
INO-71G22	1	800	730	850	12	795 x 490	3/4"
INO-71G30	1.5	1200	730	850	15	1194 x 490	3/4"

**INO-71G31**

 IZGARA / OLUKLU  
 GRILL / RIBBED

**INO-71G32**

 IZGARA / OLUKLU  
 1/3 OLUKLU 2/3 DÜZ  
 GRILL / RIBBED  
 1/3 RIBBED 2/3 SMOOTH

MODEL	MODÜL	GENİŞLİK	DERİNLİK	YÜKSEKLİK	ISI KAPASİTESİ	IZGARA ÖLÇÜSÜ	GAZ GİRİŞİ
	MODULE	WIDTH	DEPTH	HEIGHT	HEAT CAP.	GRILL SIZE	GAS INLET
		mm	mm	mm	kW	mm	Inch
INO-71G31	1.5	1200	730	850	15	1194 x 490	3/4"
INO-71G32	1.5	1200	730	850	15	1194 x 490	3/4"

**INO-71G10**

 LAVATAŞLI IZGARA  
 LAVASTONE GRILL

**INO-71G20**

 LAVATAŞLI IZGARA  
 LAVASTONE GRILL

**INO-71G30**

 LAVATAŞLI IZGARA  
 LAVASTONE GRILL

MODEL	MODÜL	GENİŞLİK	DERİNLİK	YÜKSEKLİK	ISI KAPASİTESİ	IZGARA ÖLÇÜSÜ	GAZ GİRİŞİ
	MODULE	WIDTH	DEPTH	HEIGHT	HEAT CAP.	GRILL SIZE	GAS INLET
		mm	mm	mm	kW	mm	Inch
INO-71G10	1/2	400	730	850	8,3	395 x 465	3/4"
INO-71G20	1	800	730	850	16,5	795 x 465	3/4"
INO-71G30	1.5	1200	730	850	24,75	1195x484	3/4"

**INO-7ZG10**

 SULU IZGARA  
GRILL WITH  
WATER SYSTEM

**INO-7ZG20**

 SULU IZGARA  
GRILL WITH  
WATER SYSTEM

**INO-7ZG30**

 SULU IZGARA  
GRILL WITH  
WATER SYSTEM

MODEL	MODÜL	GENİŞLİK	DERİNLİK	YÜKSEKLİK	ISI KAPASİTESİ	IZGARA ÖLÇÜSÜ	GAZ GİRİŞİ
	MODULE	WIDTH	DEPTH	HEIGHT	HEAT CAP.	GRILL SIZE	GAS INLET
		mm	mm	mm	kW	mm	Inch
INO-7ZG10	1/2	400	730	850	8,3	395 x 510	3/4"
INO-7ZG20	15	1200	730	850	24,75	1195 x 484	3/4"
INO-7ZG30	1	800	730	850	16,5	795 x 510	3/4"

**INO-70G10**

 SHOW OCAĞI  
SHOW COOKER

**INO-70G10W**

 WOK OCAĞI  
WOK COOKER

MODEL	MODÜL	GENİŞLİK	DERİNLİK	YÜKSEKLİK	ISI KAPASİTESİ	BRÜLÖR	GAZ GİRİŞİ
	MODULE	WIDTH	DEPTH	HEIGHT	HEAT CAP.	BURNER	GAS INLET
		mm	mm	mm	kW	Ø-Adet / Ø-Adet Ø-Piece / Ø-Piece	Inch
INO-70G10	1/2	400	730	850	9	Ø130 x 1	3/4"
INO-70G10W	1/2	400	730	850	15,5	Ø190 x 1	3/4"

**İNÜKSİYONLU WOK OCAK**  
**INDUCTION WOK COOKER**
**INO-70E10W**

**İNÜKSİYONLU OCAK**  
**INDUCTION COOKER**
**INO-70E10I**

**İNÜKSİYONLU OCAK**  
**INDUCTION COOKER**
**INO-70E20I**

MODEL	MODÜL	GENİŞLİK	DERİNLİK	YÜKSEK.	ISI KAP.	WOK ÇAPI	CAM ÖLÇÜSÜ	ELEKTRİK GİRİŞİ
	MODULE	WIDTH	DEPTH	HEIGHT	HEAT CAP.	WOK DIAMETER	CERAMIC GLASS SIZE	ELECTRIC INLET
		mm	mm	mm	kW	mm	mm	V
INO-70E10W	1/2	400	730	850	5	Ø300	-	380 - 400 V / 3N 50-60 Hz
INO-70E10I	1/2	400	730	850	7	-	530 x 320	380 - 400 V / 3N 50-60 Hz
INO-70E20I	1	800	730	850	14	-	2 x 530 x 320	380 - 400 V / 3N 50-60 Hz

**SOS BENMARI**  
**BAIN MARIE**
**INO-7BE10**

**SOS BENMARI**  
**BAIN MARIE**
**INO-7BE20**

MODEL	MODÜL	GENİŞLİK	DERİNLİK	YÜKSEKLİK	ISI KAPASİTESİ	ELEKTRİK GİRİŞİ	GAZ GİRİŞİ
	MODULE	WIDTH	DEPTH	HEIGHT	HEAT CAP.	ELECTRIC INLET	GAS INLET
		mm	mm	mm	kW	V	Inch
INO-7BE10	1/2	400	730	850	1,5	220 - 230 V / 1N 50-60 Hz	-
INO-7BE20	1	800	730	850	3	220 - 230 V / 1N 50-60 Hz	-

**PATATES DİNLENDİRME**  
**FRENCH FRIES WARMER**
**INO-7HE10**

MODEL	MODÜL	GENİŞLİK	DERİNLİK	YÜKSEKLİK	ISI KAPASİTESİ	KAPASİTE	ELEKTRİK GİRİŞİ
	MODULE	WIDTH	DEPTH	HEIGHT	HEAT CAP.	CAPACITY	ELECTRIC INLET
		mm	mm	mm	kW	mm	V
INO-7HE10	1/2	400	730	850	1	GN 1/1 x 100	220 - 230 V / 1N 50-60 Hz

**INO-7FE10**
**FRİTÖZ  
FRYER**

**INO-7FE20**
**FRİTÖZ  
FRYER**

MODEL	MODÜL	GENİŞLİK	DERİNLİK	YÜKSEKLİK	ISI KAPASİTESİ	YAĞ KAPASİTESİ	ELEKTRİK GİRİŞİ
	MODULE	WIDTH	DEPTH	HEIGHT	HEAT CAP.	OIL CAPACITY	ELECTRIC INLET
		mm	mm	mm	kW	Lt	V
INO-7FE10	1/2	400	730	850	12	16	380 - 400V / 3N50-60Hz
INO-7FE20	1	800	730	850	24	16+16	380 - 400V / 3N50-60Hz

**INO-7FG10**
**FRİTÖZ  
FRYER**

**INO-7FG20**
**FRİTÖZ  
FRYER**

MODEL	MODÜL	GENİŞLİK	DERİNLİK	YÜKSEKLİK	ISI KAPASİTESİ	YAĞ KAPASİTESİ	ELEKTRİK GİRİŞİ	GAZ GİRİŞİ
	MODULE	WIDTH	DEPTH	HEIGHT	HEAT CAP.	OIL CAPACITY	ELECTRIC INLET	GAS INLET
		mm	mm	mm	kW	Lt	V	Inch
INO-7FG10	1/2	400	730	850	14	18	-	3/4"
INO-7FG20	1	800	730	850	28	18+18	-	3/4»

**INO-7FE10S**
**FRİTÖZ  
FRYER**

**INO-7FE20S**
**FRİTÖZ  
FRYER**

**INO-7FE10S-S**
**FRİTÖZ  
FRYER**

**INO-7FE20S-S**
**FRİTÖZ  
FRYER**

MODEL	MODÜL	GENİŞLİK	DERİNLİK	YÜKSEKLİK	ISI KAPASİTESİ	YAĞ KAPASİTESİ	ELEKTRİK GİRİŞİ
	MODULE	WIDTH	DEPTH	HEIGHT	HEAT CAP.	OIL CAP.	ELECTRIC INLET
		mm	mm	mm	kW	Lt	V
INO-7FE10S	1/2	400	730	285	12	16	380 - 400V / 3N50-60Hz
INO-7FE20S	1	800	730	285	24	16+16	380 - 400V / 3N50-60Hz
INO-7FE10S-S	1/2	400	730	285	10,5	16	380 - 400V / 3N50-60Hz
INO-7FE20S-S	1	800	730	285	21	16+16	380 - 400V / 3N50-60Hz



MAKARNA HAŞLAMA  
PASTA COOKER

**INO-7ME10**



MAKARNA HAŞLAMA  
PASTA COOKER

**INO-7ME20**



MAKARNA HAŞLAMA  
PASTA COOKER

**INO-7MG10**



MAKARNA HAŞLAMA  
PASTA COOKER

**INO-7MG20**



MODEL	MODÜL	GENİŞLİK	DERİNLİK	YÜKSEKLİK	ISI KAPASİTESİ	HAVUZ KAPASİTESİ	ELEKTRİK GİRİŞİ	GAZ GİRİŞİ	SU GİRİŞİ (Soğuk / Sıcak)
	MODULE	WIDTH	DEPTH	HEIGHT	HEAT CAP.	POOL CAP.	ELECTRIC INLET	GAS INLET	WATER INLET (Cold / Hot)
		mm	mm	mm	kW	lt	V	Inch	Inch
INO-7ME10	1/2	400	730	850	6	14	380 - 400 V / 3N 50-60 Hz	-	3/4"
INO-7ME20	1	800	730	850	12	14 + 14	380 - 400 V / 3N 50-60 Hz	-	3/4"
INO-7MG10	1/2	400	730	850	8,5	30	-	3/4»	3/4"
INO-7MG20	1	800	730	850	17	30 +30	-	3/4»	3/4"



KAYNATMA TENCERESİ  
BOILING PAN

**INO-7SE05**



KAYNATMA TENCERESİ  
BOILING PAN

**INO-7SG05**



MODEL	MODÜL	GENİŞLİK	DERİNLİK	YÜKSEKLİK	ISI KAP.	ISITMA TİPİ	HAVUZ KAP.	ELEKTRİK GİRİŞİ	GAZ GİRİŞİ	SU GİRİŞİ (Soğuk / Sıcak)
	MODULE	WIDTH	DEPTH	HEIGHT	HEAT CAP.	HEAT TYPE	POOL CAP.	ELECTRIC INLET	GAS INLET	WATER INLET (Cold / Hot)
		mm	mm	mm	kW		lt	V	Inch	Inch
INO-7SE05	1	600	730	850	6	İndirek Indirect	50	380 - 400 V / 3N 50-60 Hz	-	3/4"
INO-7SG05	1	600	730	850	10	İndirek Indirect	50	-	3/4"	3/4"



DEVRİLİR TAVA  
TILTING BRATT PAN

**INO-7DE06**



DEVRİLİR TAVA  
TILTING BRATT PAN

**INO-7DG06**



MODEL	MODÜL	GENİŞLİK	DERİNLİK	YÜKSEKLİK	ISI KAP.	HAVUZ KAP.	ELEKTRİK GİRİŞİ	GAZ GİRİŞİ	SU GİRİŞİ (Soğuk / Sıcak)
	MODULE	WIDTH	DEPTH	HEIGHT	HEAT CAP.	POOL CAP.	ELECTRIC INLET	GAS INLET	WATER INLET (Cold / Hot)
		mm	mm	mm	kW	lt	V	Inch	Inch
INO-7DE06	1	800	730	850	7,5	60	380 - 400 V / 3N 50-60 Hz	-	3/4"
INO-7DG06	1	800	730	850	13	60	230 V / 1N 50-60 Hz	3/4"	3/4"

**INO-7DE06T**

 DEVRİLİR TAVA  
TILTING BRATT PAN

**INO-7DG06T**

 DEVRİLİR TAVA  
TILTING BRATT PAN

MODEL	MODÜL	GENİŞLİK	DERİNLİK	YÜKSEKLİK	ISI KAP.	HAVUZ KAP.	ELEKTRİK GİRİŞİ	GAZ GİRİŞİ	SU GİRİŞİ
	MODULE	WIDTH	DEPTH	HEIGHT	HEAT CAP.	POOL CAP.	ELECTRIC INLET	GAS INLET	WATER INLET
		mm	mm	mm	kW	Lt	V	Inch	Inch
INO-7DE06T	1	800	730	850	7,5	60	380 - 400 V / 3N50-60 Hz	-	3/4"
INO-7DG06T	1	800	730	850	13	60	230 V / 1N50-60 Hz	3/4"	3/4"

**INO-7TN05**

 ARA TEZGAH  
NEUTRAL TABLE

**INO-7TN10**

 ARA TEZGAH  
NEUTRAL TABLE

**INO-7TC10**

 ARA TEZGAH / ÇEKMECELİ  
NEUTRAL TABLE / DRAWER

MODEL	MODÜL	GENİŞLİK	DERİNLİK	YÜKSEKLİK
	MODULE	WIDTH	DEPTH	HEIGHT
		mm	mm	mm
INO-7TN05	1/4	200	730	850
INO-7TN10	1/2	400	730	850
INO-7TC10	1/2	400	730	850

**INO-7TE10**

 ARA TEZGAH / EYELİ  
NEUTRAL TABLE / SINK

**INO-7TN20**

 ARA TEZGAH  
NEUTRAL TABLE

**INO-7TC20**

 ARA TEZGAH / ÇEKMECELİ  
NEUTRAL TABLE / DRAWER

MODEL	MODÜL	GENİŞLİK	DERİNLİK	YÜKSEKLİK
	MODULE	WIDTH	DEPTH	HEIGHT
		mm	mm	mm
INO-7TE10	1/2	400	730	850
INO-7TN20	1	800	730	850
INO-7TC20	1	800	730	850



**INO-7TN10C**

ARA TEZGAH / ÇEKMECELİ DOLAPLI  
NEUTRAL TABLE / DRAWER



**INO-7TC10C**

ARA TEZGAH / ÇEKMECELİ ÖN PANELLİ VE DOLAPLI  
NEUTRAL TABLE / COUNTER TYPE DRAWER



MODEL	MODÜL	GENİŞLİK	DERİNLİK	YÜKSEKLİK
	MODULE	WIDTH	DEPTH	HEIGHT
		mm	mm	mm
INO-7TN10C	1/2	400	730	850
INO-7TC10C	1/2	400	730	850



**2028004010**

CEZVELİK  
COFFEE  
POD HOLDER



**2027301023**

BENMARİ  
TABAN SACI  
BAIN MARIE  
BOTTOM SHEET  
1/2 MODULE



**2027351023**

BENMARİ  
TABAN SACI  
BAIN MARIE  
BOTTOM SHEET  
1 MODULE



**2027204161**

700 SERİ  
FRİTÖZ SEPETİ BÜYÜK  
(304 KALİTE)  
700 SERİE  
BIG FRYER BASKET  
(304 QUALITY)



**2027263150**

MAKARNA  
HAŞLAMA SEPETİ  
(304 KALİTE PASLANMAZ DELİKLİ SAC)  
PASTA COOKER BASKET  
(304 QUALITY  
PERFORATED SHEET)



**2027263160**

MAKARNA  
HAŞLAMA SEPETİ  
(316 KALİTE PASLANMAZ DELİKLİ SAC)  
PASTA COOKER BASKET  
(316 QUALITY  
PERFORATED SHEET)



**2027263170**

MAKARNA  
HAŞLAMA SEPETİ  
(316 KALİTE PASLANMAZ DELİKLİ SAC)  
PASTA COOKER BASKET  
(316 QUALITY  
PERFORATED SHEET)



**2027263180**

MAKARNA  
HAŞLAMA SEPETİ  
(316 KALİTE PASLANMAZ DELİKLİ SAC)  
PASTA COOKER BASKET  
(316 QUALITY  
PERFORATED SHEET)



**2027204160**

FRİTÖZ SEPETİ  
FRYER BASKET

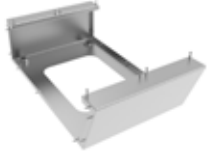

**2027001600**

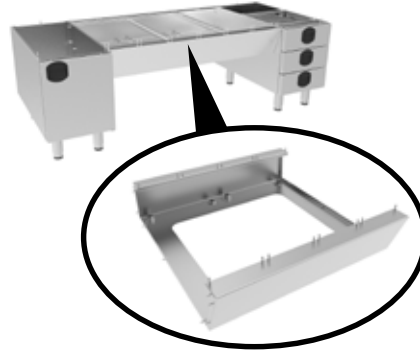
 KÖPRÜ STAND  
SUPPORT FOR  
BRIDGE SYSTEM

**2027001610**

 KÖPRÜ STAND  
SUPPORT FOR  
BRIDGE SYSTEM

**2027001620**

 KÖPRÜ STAND  
SUPPORT FOR  
BRIDGE SYSTEM

MODEL	MODÜL MODULE
2028004010	-
2027301023	1/2
2027351023	1
2027204160	-
2027263160	1/2 (1 porsiyon) / 1/2 (1 portion)
2027263140	2/1 (4 porsiyon) / 2/1 (4 portion)
2027263150	1/2 (1 porsiyon) / 1/2 (1 portion)
2027001600	1/2
2027001610	1
2027001620	1,5
2027204161	1/1
2027263180	1/1
2027263141	1/1

CİHAZ	TEKLİ SEPET	BÜYÜK SEPET
7FE10	2027204160	2027204161
7FE10S		
7FE20		
7FE20S		
7FG10		
7FG20		
9FE10S		
9FE20S		

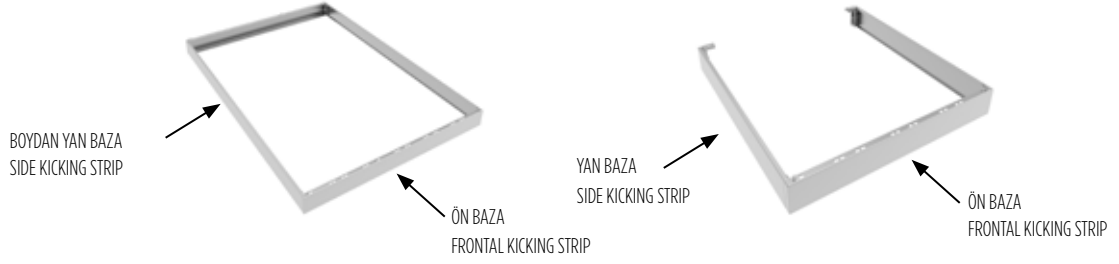
**X7**
**ÖN BAZA / BOYDAN YAN BAZA / YAN BAZA  
FRONTAL KICKING STRIP / SIDE KICKING STRIP**

MODEL	MODÜL
	DESCRIPTION
2027000441	200 mm Ön Baza / Frontal Kicking Strip
2027000440	400 mm Ön Baza / Frontal Kicking Strip
2027000450	600 mm Ön Baza / Frontal Kicking Strip
2027000451	800 mm Ön Baza / Frontal Kicking Strip
2027000460	1000 mm Ön Baza / Frontal Kicking Strip
2027000461	1200 mm Ön Baza / Frontal Kicking Strip
2027000470	1400 mm Ön Baza / Frontal Kicking Strip
2027000471	1600 mm Ön Baza / Frontal Kicking Strip
2027000480	1800 mm Ön Baza / Frontal Kicking Strip
2027000481	2000 mm Ön Baza / Frontal Kicking Strip
2027000490	2200 mm Ön Baza / Frontal Kicking Strip
2027000491	2400 mm Ön Baza / Frontal Kicking Strip
2027000420	900 Seri Boydan Yan Baza / Serie Side Kicking Strip
2027000400	900 Seri Yan Baza / Serie Side Kicking Strip



# PERFECT 900 S

## Set Üstü Pişiriciler Worktop Units



- Tüm cihazlar modüler olup, müşteri ihtiyaçlarına göre kombinasyonlar oluşturulabilir.
- Tamamen 18/8 AISI 304 paslanmaz çelikten üretilmiştir.
- Tüm modeller aralarında kirin birikmesini önleyecek şekilde tasarlanmıştır.
- Gazlı modeller alev emniyet sistemli, elektrikli modeller ise emniyet termostatlıdır.
- Tüm cihazlar ergonomik kullanım tarzı düşünülerek tasarlanmıştır.
- Gazlı ve elektrikli tüm modeller CE şartlarına uygundur.
- Cihazların hat şeklinde birbirlerine bağlanmalarına imkan verecek şekilde tasarlanmıştır.

- The perfect 900 Serie is completely modular for limitless combinations and has been specially designed for our customer needs.
- All devices and equipment are manufactured from AISI304 grade 18/8 Cr/Ni stainless steel.
- Connection between side to side models has been specially designed to avoid dirtiness.
- Gas and electric versions available all equipped with safety pilots and thermocouple/flame failure device.
- Esthetic and ergonomic buttons and panels.
- Easy cleaning thanks to rounded design.
- Highest international standards are achieved.

**INO-9KE10S**

 KUZİNE  
COOKER

**INO-9KE20S**

 KUZİNE  
COOKER

**INO-9KE30S**

 KUZİNE  
COOKER

**INO-9KE11S**

 SERAN CAMLI OCAK  
CERAN GLASS COOKER

**INO-9KE21S**

 SERAN CAMLI OCAK  
CERAN GLASS COOKER

MODEL	MODÜL	GENİŞLİK	DERİNLİK	YÜKSEKLİK	ISI KAPASİTESİ	ELEKTRİK GİRİŞİ
	MODULE	WIDTH	DEPTH	HEIGHT	HEAT CAPACITY	ELECTRIC INLET
		mm	mm	mm	kw	V
INO-9KE10S	1/2	400	900	285	8	380-400V / 3N 50-60Hz
INO-9KE20S	1	800	900	285	16	380-400V / 3N 50-60Hz
INO-9KE30S	1.5	1200	900	285	24	380-400V / 3N 50-60Hz
INO-9KE11S	1/2	400	900	285	6	380-400V / 3N 50-60Hz
INO-9KE21S	1	800	900	285	12	380-400V / 3N 50-60Hz

**INO-9KG10S**

 KUZİNE  
COOKER

**INO-9KG20S**

**INO-9KG30S**

**INO-9KG21S**

 KUZİNE /  
KAPALI DÖKÜM

MODEL	MODÜL	GENİŞLİK	DERİNLİK	YÜKSEKLİK	ISI KAPASİTESİ	BRÜLÖR	GAZ GİRİŞİ
	MODULE	WIDTH	DEPTH	HEIGHT	HEAT CAPACITY	BURNER	GAS INLET
		mm	mm	mm	kw	Ø-Adet / Ø-Adet	Inch
INO-9KG10S	1/2	400	900	285	15	Ø100 x1 ve Ø130 x1	3/4"
INO-9KG20S	1	800	900	285	30	Ø100 x2 ve Ø130 x2	3/4"
INO-9KG30S	1.5	1200	900	285	45	Ø100 x3 ve Ø130 x3	3/4"
INO-9KG21S	1	800	900	285	9	Ø130 x1	3/4"

**INO-90G20S**

 SHOW OCAĞI  
SHOW COOKER

**INO-90G10WS**

 WOK OCAĞI  
WOK COOKER

MODEL	MODÜL	GENİŞLİK	DERİNLİK	YÜKSEKLİK	ISI KAPASİTESİ	BRÜLÖR	GAZ GİRİŞİ
	MODULE	WIDTH	DEPTH	HEIGHT	HEAT CAPACITY	BURNER	GAS INLET
		mm	mm	mm	kw	Ø-Adet / Ø-Adet	Inch
INO-90G20S	1	800	900	285	20	Ø 265 x 1	3/4"
INO-90G10WS	1/2	400	900	285	15,5	Ø 190 x 1	3/4"

**INO-91E10S**

 IZGARA / DÜZ  
GRILL / SMOOTH

**INO-91E11S**

 IZGARA / OLUKLU  
GRILL / RIBBED

**INO-91E20S**

 IZGARA / DÜZ  
GRILL / SMOOTH

**INO-91E21S**

 IZGARA / OLUKLU  
GRILL / RIBBED

MODEL	MODÜL	GENİŞLİK	DERİNLİK	YÜKSEKLİK	ISI KAPASİTESİ	IZGARA ÖLÇÜSÜ	ELEKTRİK GİRİŞİ
	MODULE	WIDTH	DEPTH	HEIGHT	HEAT CAPACITY	GRILL SIZE	ELECTRIC INLET
		mm	mm	mm	kw	mm	V
INO-91E10S	1/2	400	900	285	6	394x660	380-400V / 3N 50-60Hz
INO-91E11S	1/2	400	900	285	6	394x660	380-400V / 3N 50-60Hz
INO-91E20S	1	800	900	285	12	794x660	380-400V / 3N 50-60Hz
INO-91E21S	1	800	900	285	12	794x660	380-400V / 3N 50-60Hz



**INO-91E22S**  
IZGARA / GRILL 1/2  
OLUKLU / RIBBED  
+1/2 DÜZ / SMOOTH



**INO-91E30S**

IZGARA / DÜZ  
GRILL / SMOOTH



**INO-91E31S**

IZGARA / OLUKLU  
GRILL / RIBBED



**INO-91E32S**

IZGARA / GRILL 1/3  
OLUKLU / RIBBED  
+2/3 DÜZ / SMOOTH



MODEL	MODÜL	GENİŞLİK	DERİNLİK	YÜKSEKLİK	ISI KAPASİTESİ	IZGARA ÖLÇÜSÜ	ELEKTRİK GİRİŞİ
	MODULE	WIDTH	DEPTH	HEIGHT	HEAT CAPACITY	GRILL SIZE	ELECTRIC INLET
		mm	mm	mm	kw	mm	V
INO-91E22S	1	800	900	285	12	794x660	380-400V / 3N 50-60Hz
INO-V	1.5	1200	900	285	18	1194x660	380-400V / 3N 50-60Hz
INO-91E31S	1.5	1200	900	285	18	1194x660	380-400V / 3N 50-60Hz
INO-91E32S	1.5	1200	900	285	18	1194x660	380-400V / 3N 50-60Hz



**INO-91G10S**

IZGARA / DÜZ  
GRILL / SMOOTH



**INO-91G11S**

IZGARA / OLUKLU  
GRILL / RIBBED



**INO-91G20S**

IZGARA / DÜZ  
GRILL / SMOOTH



**INO-91G21S**

IZGARA / OLUKLU  
GRILL / RIBBED



MODEL	MODÜL	GENİŞLİK	DERİNLİK	YÜKSEKLİK	ISI KAPASİTESİ	IZGARA ÖLÇÜSÜ	GAZ GİRİŞİ
	MODULE	WIDTH	DEPTH	HEIGHT	HEAT CAPACITY	GRILL SIZE	GAS INLET
		mm	mm	mm	kw	mm	Inch
INO-91G10S	1/2	400	900	285	7	394x660	3/4"
INO-91G11S	1/2	400	900	285	7	394x660	3/4"
INO-91G20S	1	800	900	285	14	794x660	3/4"
INO-91G21S	1	800	900	285	14	794x660	3/4"

**INO-9IG22S**

 IZGARA / GRILL 1/2  
 OLUKLU / RIBBED  
 +1/2 DÜZ / SMOOTH

**INO-9IG30S**

 IZGARA / DÜZ  
 GRILL / SMOOTH

**INO-9IG31S**

 IZGARA / OLUKLU  
 GRILL / RIBBED

**INO-9IG32S**

 IZGARA / GRILL 1/3  
 OLUKLU / RIBBED  
 +2/3 DÜZ / SMOOTH

MODEL	MODÜL	GENİŞLİK	DERİNLİK	YÜKSEKLİK	ISI KAPASİTESİ	IZGARA ÖLÇÜSÜ	GAZ GİRİŞİ
	MODULE	WIDTH	DEPTH	HEIGHT	HEAT CAPACITY	GRILL SIZE	GAS INLET
		mm	mm	mm	kW	mm	Inch
INO-9IG22S	1	800	900	285	14	794x660	3/4"
INO-9IG30S	1.5	1200	900	285	18	1194x660	3/4"
INO-9IG31S	1.5	1200	900	285	18	1194x660	3/4"
INO-9IG32S	1.5	1200	900	285	18	1194x660	3/4"

**INO-9LG10S**

 IZGARA/LAVATAŞLI  
 GRILL / LAVASTONE

**INO-9LG20S**

 IZGARA/LAVATAŞLI  
 GRILL / LAVASTONE

**INO-9LG30S**

 IZGARA/LAVATAŞLI  
 GRILL / LAVASTONE

MODEL	MODÜL	GENİŞLİK	DERİNLİK	YÜKSEKLİK	ISI KAPASİTESİ	IZGARA ÖLÇÜSÜ	GAZ GİRİŞİ
	MODULE	WIDTH	DEPTH	HEIGHT	HEAT CAPACITY	GRILL SIZE	GAS INLET
		mm	mm	mm	kW	mm	Inch
INO-9LG10S	1/2	400	900	285	10,3	395x588	3/4"
INO-9LG20S	1	800	900	285	20,6	795x588	3/4"
INO-9LG30S	1.5	1200	900	285	30,9	1195x588	3/4"

**INO-9ZG10S**

SULU IZGARA  
GRILL WITH  
WATER SYSTEM

**INO-9ZG20S**

SULU IZGARA  
GRILL WITH  
WATER SYSTEM

**INO-9ZG30S**

SULU IZGARA  
GRILL WITH  
WATER SYSTEM



MODEL	MODÜL	GENİŞLİK	DERİNLİK	YÜKSEKLİK	ISI KAPASİTESİ	IZGARA ÖLÇÜSÜ	GAZ GİRİŞİ
	MODULE	WIDTH	DEPTH	HEIGHT	HEAT CAPACITY	GRILL SIZE	GAS INLET
		mm	mm	mm	kw	mm	Inch
INO-9ZG10S	1/2	400	900	285	10,3	395x588	3/4"
INO-9ZG20S	1	800	900	285	20,6	795x588	3/4"
INO-9ZG30S	1.5	1200	900	285	30,9	1195x588	3/4"

**INO-90E10WS**

İNDÜKSİYONLU WOK OCAK  
INDUCTION WOK COOKER

**INO-90E10IS**

İNDÜKSİYONLU OCAK  
INDUCTION COOKER

**INO-90E20IS**

İNDÜKSİYONLU OCAK  
INDUCTION COOKER



MODEL	MODÜL	GENİŞLİK	DERİNLİK	YÜKSEKLİK	ISI KAPASİTESİ	WOK ÇAPI	CAM ÖLÇÜSÜ	ELEKTRİK GİRİŞİ
	MODULE	WIDTH	DEPTH	HEIGHT	HEAT CAPACITY	WOK DIAMETER	CERAMIC GLASS SIZE	ELECTRIC INLET
		mm	mm	mm	kw	mm	mm	V
INO-90E10WS	1/2	400	900	285	5	Ø300	-	380-400 V / 3N 50-60 Hz.
INO-90E10IS	1/2	400	900	285	10	-	720 x 360	380-400 V / 3N 50-60 Hz.
INO-90E20IS	1	800	900	285	20	-	2*720 x 360	380-400 V / 3N 50-60 Hz.



**INO-9BE10S**

SOS BENMARI  
BAIN MARIE



**INO-9BE20S**

SOS BENMARI  
BAIN MARIE



MODEL	MODÜL	GENİŞLİK	DERİNLİK	YÜKSEKLİK	ISI KAPASİTESİ	ELEKTRİK GİRİŞİ
	MODULE	WIDTH	DEPTH	HEIGHT	HEAT CAPACITY	ELECTRIC INLET
		mm	mm	mm	kw	V
INO-9BE10S	1/2	400	900	285	1,5	220-230 V / 1N 50-60 Hz.
INO-9BE20S	1	800	900	285	3	220-230 V / 1N 50-60 Hz.



**INO-9HE10S**

PATATES DİNLENDİRME  
FRENCH FRIES WARMER



MODEL	MODÜL	GENİŞLİK	DERİNLİK	YÜKSEKLİK	ISI KAPASİTESİ	KAPASİTE	ELEKTRİK GİRİŞİ
	MODULE	WIDTH	DEPTH	HEIGHT	HEAT CAPACITY	CAPACITY	ELECTRIC INLET
		mm	mm	mm	kw	GN	V
INO-9HE10S	1/2	400	900	285	1	GN1/1 x 100	220-230 V / 1N 50-60 Hz.



**INO-9FE10S**

FRİTÖZ  
FRYER



**INO-9FE20S**



FRİTÖZ  
FRYER



**INO-9FE10S-S**

FRİTÖZ  
FRYER



MODEL	MODÜL	GENİŞLİK	DERİNLİK	YÜKSEKLİK	ISI KAPASİTESİ	KAPASİTE	ELEKTRİK GİRİŞİ
	MODULE	WIDTH	DEPTH	HEIGHT	HEAT CAPACITY	CAPACITY	ELECTRIC INLET
		mm	mm	mm	kw	LT	V
INO-9FE10S	1/2	400	900	285	12	16	380-400 V / 3N 50-60 Hz.
INO-9FE20S	1	800	900	285	24	16+16	380-400 V / 3N 50-60 Hz.
INO-9FE10S-S	1/2	400	900	285	10,5	16	380-400 V / 3N 50-60 Hz.

**INO-9FE20S-S**
**FRİTÖZ  
FRYER**

MODEL	MODÜL	GENİŞLİK	DERİNLİK	YÜKSEKLİK	ISI KAPASİTESİ	KAPASİTE	ELEKTRİK GİRİŞİ
	MODULE	WIDTH	DEPTH	HEIGHT	HEAT CAPACITY	CAPACITY	ELECTRIC INLET
		mm	mm	mm	kw	LT	V
INO-9FE20S-S	1	800	900	285	21	16+16	380-400 V / 3N 50-60 Hz.

**INO-9ME10S**
**MAKARNA HAŞLAMA  
PASTA COOKER**

**INO-9ME20S**
**MAKARNA HAŞLAMA  
PASTA COOKER**

MODEL	MODÜL	GENİŞLİK	DERİNLİK	YÜKSEKLİK	ISI KAPASİTESİ	HAVUZ KAPASİTESİ	ELEKTRİK GİRİŞİ	SU GİRİŞİ
	MODULE	WIDTH	DEPTH	HEIGHT	HEAT CAPACITY	POOL CAPACITY	ELECTRIC INLET	WATER INLET
		mm	mm	mm	kw	V	V	Inch
INO-9ME10S	1/2	400	900	285	6	15	380-400 V / 3N 50-60 Hz.	3/4"
INO-9ME20S	1	800	900	285	12	15+15	380-400 V / 3N 50-60 Hz.	3/4"



**INO-9TN05S**

ARA TEZGAH  
NEUTRAL TABLE



**INO-9TN10S**

ARA TEZGAH  
NEUTRAL TABLE



MODEL	MODÜL	GENİŞLİK	DERİNLİK	YÜKSEKLİK
	MODULE	WIDTH	DEPTH	HEIGHT
		mm	mm	mm
INO-9TN05S	1/4	400	900	285
INO-9TN10S	1/2	400	900	285



**INO-9TC10S**

ARA TEZGAH / ÇEKMECELİ NEUTRAL  
TABLE / DRAWERS

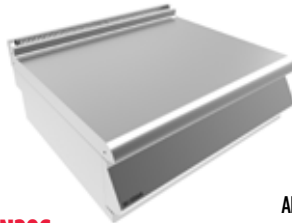

**INO-9TN20S**

ARA TEZGAH  
NEUTRAL TABLE



MODEL	MODÜL	GENİŞLİK	DERİNLİK	YÜKSEKLİK
	MODULE	WIDTH	DEPTH	HEIGHT
		mm	mm	mm
INO-9TC10S	1/2	400	900	285
INO-9TN20S	1	800	900	285



**INO-9TC20S**

ARA TEZGAH/ÇEKMECELİ  
NEUTRAL TABLE DRAWER



**INO-9TE10S**

ARA TEZGAH  
NEUTRAL TABLE



MODEL	MODÜL	GENİŞLİK	DERİNLİK	YÜKSEKLİK
	MODULE	WIDTH	DEPTH	HEIGHT
		mm	mm	mm
INO-9TC20S	1	800	900	285
INO-9TE10S	1/2	400	900	285



# PERFECT 700 S

## Set Üstü Pişiriciler Worktop Units



- Tüm cihazlar modüler olup, müşteri ihtiyaçlarına göre kombinasyonlar oluşturulabilir.
- Tamamen 18/8 AISI 304 paslanmaz çelikten üretilmiştir.
- Tüm modeller aralarında kirin birikmesini önleyecek şekilde tasarlanmıştır.
- Gazlı modeller alev emniyet sistemli, elektrikli modeller ise emniyet termostatlıdır.
- Tüm cihazlar ergonomik kullanım tarzı düşünülerek tasarlanmıştır.
- Gazlı ve elektrikli tüm modeller CE şartlarına uygundur.
- Cihazların hat şeklinde birbirlerine bağlanmalarına imkan verecek şekilde tasarlanmıştır.

- The perfect 700 Serie is completely modular for limitless combinations and has been specially designed for our customer needs.
- All devices and equipment are manufactured from AISI304 grade 18/8 Cr/Ni stainless steel.
- Connection between side to side models has been specially designed to avoid dirtiness.
- Gas and electric versions available all equipped with safety pilots and thermocouple/flame failure device.
- Esthetic and ergonomic buttons and panels.
- Easy cleaning thanks to rounded design.
- Highest international standards are achieved.

**INO-7KE10S**

 KUZİNE  
COOKER

**INO-7KE20S**

 KUZİNE  
COOKER

**INO-7KE30S**

 KUZİNE  
COOKER

MODEL	MODÜL	GENİŞLİK	DERİNLİK	YÜKSEKLİK	ISI KAPASİTESİ	ELEKTRİK GİRİŞİ
	MODULE	WIDTH	DEPTH	HEIGHT	HEAT CAPACITY	ELECTRIC INLET
		mm	mm	mm	kW	V
INO-7KE10S	1/2	400	730	285	4,6	380 - 400 V / 3N 50-60 Hz
INO-7KE20S	1	800	730	285	9,2	380 - 400 V / 3N 50-60 Hz
INO-7KE30S	1,5	1200	730	285	13,8	380 - 400 V / 3N 50-60 Hz

**INO-7KE10KS**

 KARE PLEYTLİ KUZİNE  
COOKER WITH SQUARE PLATE

**INO-7KE20KS**

 KARE PLEYTLİ KUZİNE  
COOKER WITH SQUARE PLATE

**INO-7KE20KS**

 KARE PLEYTLİ KUZİNE  
COOKER WITH SQUARE PLATE

MODEL	MODÜL	GENİŞLİK	DERİNLİK	YÜKSEKLİK	ISI KAPASİTESİ	ELEKTRİK GİRİŞİ
	MODULE	WIDTH	DEPTH	HEIGHT	HEAT CAPACITY	ELECTRIC INLET
		mm	mm	mm	kW	V
INO-7KE10KS	1/2	400	730	285	5,2	380 - 400 V / 3N 50-60 Hz
INO-7KE20KS	1	800	730	285	10,4	380 - 400 V / 3N 50-60 Hz
INO-7KE20KS	1,5	1200	900	285	24	380-400V / 3N 50-60Hz

**INO-7KE11S**

 SERAN CAMLI OCAK  
COOKER WITH CERAMIC GLASS

**INO-7KE21S**

 SERAN CAMLI OCAK  
COOKER WITH CERAMIC GLASS

MODEL	MODÜL	GENİŞLİK	DERİNLİK	YÜKSEKLİK	ISI KAPASİTESİ	ELEKTRİK GİRİŞİ
	MODULE	WIDTH	DEPTH	HEIGHT	HEAT CAPACITY	ELECTRIC INLET
		mm	mm	mm	kW	V
INO-7KE11S	1/2	400	730	285	5	380 - 400 V / 3N 50-60 Hz
INO-7KE21S	1	800	730	285	10	380 - 400 V / 3N 50-60 Hz

**INO-7KG10S**

 KUZİNE  
COOKER

**INO-7KG20S**

 KUZİNE  
COOKER

**INO-7KG30S**

 KUZİNE  
COOKER

MODEL	MODÜL	GENİŞLİK	DERİNLİK	YÜKSEKLİK	ISI KAPASİTESİ	BRÜLÖR	GAZ GİRİŞİ
	MODULE	WIDTH	DEPTH	HEIGHT	HEAT CAPACITY	BURNER	GAS INLET
		mm	mm	mm	kW	Ø-Adet / Ø-Adet Ø-Piece / Ø-Piece	Inch
INO-7KG10S	1/2	400	730	285	9,5	Ø75 x 1 ve Ø100 x 1	3/4"
INO-7KG20S	1	800	730	285	19	Ø75 x 2 ve Ø100 x 2	3/4"
INO-7KG30S	1,5	1200	730	285	28,5	Ø75 x 3 ve Ø100 x 3	3/4"

**INO-7IE10S**

 IZGARA / DÜZ  
GRILL / SMOOTH

**INO-7IE11S**

 IZGARA / OLUKLU  
GRILL / RIBBED

**INO-7IE20S**

 IZGARA / DÜZ  
GRILL / SMOOTH

MODEL	MODÜL	GENİŞLİK	DERİNLİK	YÜKSEKLİK	ISI KAP.	IZGARA ÖLÇÜSÜ	ELEKTRİK GİRİŞİ
	MODULE	WIDTH	DEPTH	HEIGHT	HEAT CAP.	GRILL SIZE	ELECTRIC INLET
		mm	mm	mm	kW	mm	V
INO-7IE10S	1/2	400	730	285	4,5 kW	395 x 490	380 - 400 V / 3N 50-60 Hz
INO-7IE11S	1/2	400	730	285	4,5 kW	395 x 490	380 - 400 V / 3N 50-60 Hz
INO-7IE20S	1	800	730	285	9 kW	795 x 490	380 - 400 V / 3N 50-60 Hz

**INO-7IE21S**

 IZGARA / OLUKLU  
GRILL / RIBBED

**INO-7IE22S**

 IZGARA  
1/2 DÜZ + 1/2 OLUKLU  
GRILL  
1/2 SMOOTH + 1/2 RIBBED

MODEL	MODÜL	GENİŞLİK	DERİNLİK	YÜKSEKLİK	ISI KAP.	IZGARA ÖLÇÜSÜ	ELEKTRİK GİRİŞİ
	MODULE	WIDTH	DEPTH	HEIGHT	HEAT CAP.	GRILL SIZE	ELECTRIC INLET
		mm	mm	mm	kW	mm	V
INO-7IE21S	1	800	730	285	9 kW	795 x 490	380 - 400 V / 3N 50-60 Hz
INO-7IE22S	1	800	730	285	9 kW	795 x 490	380 - 400 V / 3N 50-60 Hz

**INO-7IG10S**

 IZGARA / DÜZ  
GRILL / SMOOTH

**INO-7IG11S**

 IZGARA / OLUKLU  
GRILL / RIBBED

**INO-7IG20S**

 IZGARA / DÜZ  
GRILL / SMOOTH

MODEL	MODÜL	GENİŞLİK	DERİNLİK	YÜKSEKLİK	ISI KAPASİTESİ	IZGARA ÖLÇÜSÜ	GAZ GİRİŞİ
	MODULE	WIDTH	DEPTH	HEIGHT	HEAT CAP.	GRILL SIZE	GAS INLET
		mm	mm	mm	kW	mm	Inch
INO-7IG10S	1/2	400	730	285	6	395 x 490 mm	3/4"
INO-7IG11S	1/2	422	772	1006	6	395 x 490 mm	3/4"
INO-7IG20S	1	800	730	285	12	795 x 490 mm	3/4"

**INO-7IG21S**

 IZGARA / OLUKLU  
GRILL / RIBBED

**INO-7IG22S**

 IZGARA  
1/2 DÜZ + 1/2 OLUKLU  
GRILL  
1/2 SMOOTH + 1/2 RIBBED

MODEL	MODÜL	GENİŞLİK	DERİNLİK	YÜKSEKLİK	ISI KAPASİTESİ	IZGARA ÖLÇÜSÜ	GAZ GİRİŞİ
	MODULE	WIDTH	DEPTH	HEIGHT	HEAT CAP.	GRILL SIZE	GAS INLET
		mm	mm	mm	kW	mm	Inch
INO-7IG21S	1	800	730	285	12 kW	795 x 490 mm	3/4"
INO-7IG22S	1	800	730	285	12 kW	795 x 490 mm	3/4"

**INO-71G30S**

 IZGARA/DÜZ  
GRILL/SMOOTH

**INO-71G31S**

 IZGARA/OLUKLU  
GRILL / RIBBED

**INO-71G32S**

 IZGARA / GRILL 1/3  
OLUKLU / RIBBED  
+2/3 DÜZ / SMOOTH

MODEL	MODÜL	GENİŞLİK	DERİNLİK	YÜKSEKLİK	ISI KAPASİTESİ	IZGARA ÖLÇÜSÜ	GAZ GİRİŞİ
	MODULE	WIDTH	DEPTH	HEIGHT	HEAT CAPACITY	GRILL SIZE	GAS INLET
		mm	mm	mm	kw	mm	Inch
INO-71G30S	1.5	1200	900	285	18	1194x660	3/4"
INO-71G31S	1.5	1200	900	285	18	1194x660	3/4"
INO-71G32S	1.5	1200	900	285	18	1194x660	3/4"

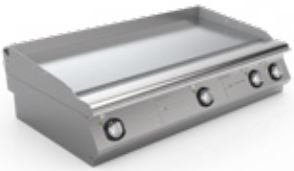
**INO-71E30S**

 IZGARA/DÜZ  
GRILL/SMOOTH

**INO-71E31S**

 IZGARA/OLUKLU  
GRILL / RIBBED

**INO-71E32S**

 IZGARA/ GRILL  
1/3 OLUKLU / RIBBED  
+2/3 DÜZ / SMOOTH

MODEL	MODÜL	GENİŞLİK	DERİNLİK	YÜKSEKLİK	ISI KAPASİTESİ	IZGARA ÖLÇÜSÜ	ELEKTRİK GİRİŞİ
	MODULE	WIDTH	DEPTH	HEIGHT	HEAT CAPACITY	GRILL SIZE	ELECTRIC INLET
		mm	mm	mm	kw	mm	V
INO-71E30S	1.5	1200	900	285	18	1194x660	380-400V / 3N 50-60Hz
INO-71E31S	1.5	1200	900	285	18	1194x660	380-400V / 3N 50-60Hz
INO-71E32S	1.5	1200	900	285	18	1194x660	380-400V / 3N 50-60Hz





**IZGARA / LAVATAŞLI  
GRILL / LAVASTONE**

**INO-7LG10S**



**IZGARA / LAVATAŞLI  
GRILL / LAVASTONE**

**INO-7LG20S**



**IZGARA / LAVATAŞLI  
GRILL / LAVASTONE**

**INO-7LG30S**



MODEL	MODÜL	GENİŞLİK	DERİNLİK	YÜKSEKLİK	ISI KAPASİTESİ	IZGARA ÖLÇÜSÜ	GAZ GİRİŞİ
	MODULE	WIDTH	DEPTH	HEIGHT	HEAT CAP.	GRILL SIZE	GAS INLET
		mm	mm	mm	kW	mm	Inch
INO-7LG10S	1/2	400	730	285	8,3	395 x 484	3/4"
INO-7LG20S	1	800	730	285	16,5	795 x 484	3/4"
INO-7LG30S	1.5	1200	730	285	24,75	1195 x 484	3/4"



**SULU IZGARA  
GRILL WITH  
WATER SYSTEM**

**INO-7ZG10S**



**INO-7ZG20S**



**SULU IZGARA  
GRILL WITH  
WATER SYSTEM**

**INO-7ZG30S**



MODEL	MODÜL	GENİŞLİK	DERİNLİK	YÜKSEKLİK	ISI KAPASİTESİ	IZGARA ÖLÇÜSÜ	GAZ GİRİŞİ
	MODULE	WIDTH	DEPTH	HEIGHT	HEAT CAP.	GRILL SIZE	GAS INLET
		mm	mm	mm	kW	mm	Inch
INO-7ZG10S	1/2	400	730	285	8,3	395 x 484	3/4"
INO-7ZG20S	1	800	730	285	16,5	795 x 510	3/4"
INO-7ZG30S	1.5	1200	730	285	24,75	795 x 484	3/4"



**SHOW OCAĞI  
SHOW COOKER**

**INO-70G10S**

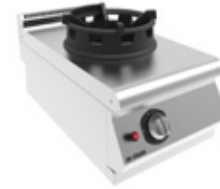

**WOK OCAĞI  
WOK COOKER**

**INO-70G10WS**



MODEL	MODÜL	GENİŞLİK	DERİNLİK	YÜKSEKLİK	ISI KAPASİTESİ	BRÜLÖR	GAZ GİRİŞİ
	MODULE	WIDTH	DEPTH	HEIGHT	HEAT CAP.	BURNER	GAS INLET
		mm	mm	mm	kW	Ø-Adet / Ø-Adet Ø-Piece / Ø-Piece	Inch
INO-70G10S	1/2	400	730	285	9	Ø130 mm x 1	3/4"
INO-70G10WS	1/2	400	730	285	15,5	Ø190 mm x 1	3/4"



**INO-70E10WS**

İNDÜKSİYONLU WOK OCAK  
INDUCTION WOK COOKER



**INO-70E10IS**

İNDÜKSİYONLU OCAK  
INDUCTION COOKER



**INO-70E20IS**

İNDÜKSİYONLU OCAK  
INDUCTION COOKER



MODEL	MODÜL	GENİŞLİK	DERİNLİK	YÜKSEKLİK	ISI KAP.	WOK ÇAPI	CAM ÖLÇÜSÜ	ELEKTRİK GİRİŞİ
	MODULE	WIDTH	DEPTH	HEIGHT	HEAT CAP.	WOK DIAMETER	CERAMIC GLASS SIZE	ELECTRIC INLET
		mm	mm	mm	kW	mm	mm	V
INO-70E10WS	1/2	400	730	285	5	Ø300	-	380 - 400 V / 3N 50-60 Hz
INO-70E10IS	1/2	400	730	285	7	-	530 x 320	380 - 400 V / 3N 50-60 Hz
INO-70E20IS	1	800	730	285	14	-	2 x 530 x 320	380 - 400 V / 3N 50-60 Hz



**INO-7BE10S**

SOS BENMARI  
BAIN MARIE



**INO-7BE20S**

SOS BENMARI  
BAIN MARIE



MODEL	MODÜL	GENİŞLİK	DERİNLİK	YÜKSEKLİK	ISI KAPASİTESİ	ELEKTRİK GİRİŞİ	GAZ GİRİŞİ
	MODULE	WIDTH	DEPTH	HEIGHT	HEAT CAP.	ELECTRIC INLET	GAS INLET
		mm	mm	mm	kW	V	Inch
INO-7BE10S	1/2	400	730	285	1,5	220 - 230 V / 50-60 Hz	-
INO-7BE20S	1	800	730	285	3	220 - 230 V / 50-60 Hz	-



**INO-7HE10S**

PATATES DİNLENDİRME  
FRENCH FRIES WARMER



MODEL	MODÜL	GENİŞLİK	DERİNLİK	YÜKSEKLİK	ISI KAPASİTESİ	KAPASİTE	ELEKTRİK GİRİŞİ
	MODULE	WIDTH	DEPTH	HEIGHT	HEAT CAP.	CAPACITY	ELECTRIC INLET
		mm	mm	mm	kW	GN	V
INO-7HE10S	1/2	400	730	285	1	GN 1/1 x 100	220 - 230 V / 50-60 Hz

**INO-7FE10S**

 FRİTÖZ  
FRYER

**INO-7FE20S**

 FRİTÖZ  
FRYER

**INO-7FE10S-S**

 FRİTÖZ  
FRYER

**INO-7FE20S-S**

 FRİTÖZ  
FRYER

MODEL	MODÜL	GENİŞLİK	DERİNLİK	YÜKSEKLİK	ISI KAPASİTESİ	YAĞ KAPASİTESİ	ELEKTRİK GİRİŞİ
	MODULE	WIDTH	DEPTH	HEIGHT	HEAT CAP.	OIL CAP.	ELECTRIC INLET
		mm	mm	mm	kW	Lt	V
INO-7FE10S	1/2	400	730	285	12	16	380-400V/3N50-60Hz
INO-7FE20S	1	800	730	285	24	16+16	380-400V/3N50-60Hz
INO-7FE10S-S	1/2	400	730	285	10,5	16	380-400V/3N50-60Hz
INO-7FE20S-S	1	800	730	285	21	16+16	380-400V/3N50-60Hz

**INO-7ME10S**

 MAKARNA HAŞLAMA  
PASTA COOKER

**INO-7ME20S**

 MAKARNA HAŞLAMA  
PASTA COOKER

MODEL	MODÜL	GENİŞLİK	DERİNLİK	YÜKSEKLİK	ISI KAP.	HAVUZ KAP.	ELEKTRİK GİRİŞİ	SU GİRİŞİ (soğuk / sıcak)
	MODULE	WIDTH	DEPTH	HEIGHT	HEAT CAP.	OIL CAP.	ELECTRIC INLET	WATER INLET (Cold / Hot)
		mm	mm	mm	kW	lt	V	Inch
INO-7ME10S	1/2	400	730	285	6 kW	15 Lt	380 - 400 V / 3N 50-60 Hz	3/4"
INO-7ME20S	1	800	730	285	12 kW	15 + 15 Lt	380 - 400 V / 3N 50-60 Hz	3/4"

**INO-7TN05S**

 ARA TEZGAH  
NEUTRAL TABLE

**INO-7TN10S**

 ARA TEZGAH  
NEUTRAL TABLE

**INO-7TC10S**

 ARA TEZGAH / ÇEKMECELİ  
NEUTRAL TABLE / DRAWERS

MODEL	MODÜL	GENİŞLİK	DERİNLİK	YÜKSEKLİK
	MODULE	WIDTH	DEPTH	HEIGHT
		mm	mm	mm
INO-7TN05S	1/4	200	730	285
INO-7TN10S	1/2	400	730	285
INO-7TC10S	1/2	400	730	285

**INO-7TE10S**

 ARA TEZGAH / EYVELİ  
 NEUTRAL TABLE / SINK

**INO-7TN20S**

 ARA TEZGAH  
 NEUTRAL TABLE

**INO-7TC20S**

 ARA TEZGAH / ÇEKMECELİ  
 NEUTRAL TABLE / DRAWERS

MODEL	MODÜL	GENİŞLİK	DERİNLİK	YÜKSEKLİK
	MODULE	WIDTH	DEPTH	HEIGHT
		mm	mm	mm
INO-7TE10S	1/2	400	730	285
INO-7TN20S	1	800	730	285
INO-7TC20S	1	800	730	285

Batarya standart ürün fiyatına dahil değildir.  
 Tap not included the price.



**INO-7GA10**

 ALT STAND  
 BOTTOM STAND

**INO-7GA20**

 ALT STAND  
 BOTTOM STAND

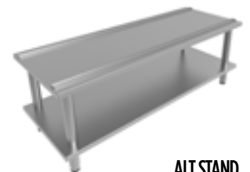
**INO-7GA30**

 ALT STAND  
 BOTTOM STAND

**INO-7GA40**

 ALT STAND  
 BOTTOM STAND

MODEL	MODÜL	GENİŞLİK	DERİNLİK	YÜKSEKLİK
	MODULE	WIDTH	DEPTH	HEIGHT
		mm	mm	mm
INO-7GA10	1/2	400	600	565
INO-7GA20	1	800	600	565
INO-7GA30	1,5	1200	600	565
INO-7GA40	2	1600	600	565

**INO-7MONO1**
**MONOBLOK**

OCAK	
Toplam Güç:	20 kW (5kW x 4ad. / pr.)
Brülör	5kW %62 verim / efficiency
İç Brülör	0,8 kW (max) - 0,2 kW (min)
Dış Brülör	4,2 kW (max) - 1,2 kW (min)
Kullanım Alanı	535x335 mms
Kapasite	Ø 250 mm x 4 tencere Ø 320 mm x 2 tencere + Ø 180 mm x 2 tencere
Gaz Girişi	R 1/2" (30 mbar G30 / 20mbar G20)
İNDÜKSİYON WOK	
Toplam Güç:	5 kW
Kapasite	Ø 300 mm wok tavası / wok
Enerji Girişi	380 V 50-60 Hz
FRİTÖZ	
Toplam Güç:	12 kW
Kapasite	12 lt. yağ / 1,5 kg patates
Enerji Girişi	380 V 50-60 Hz
MAKARNA PİŞİRİCİ	
Toplam Güç:	6 kW
Kapasite	15 lt. su / 4 porsiyon
Enerji Girişi	380 V 50-60 Hz
BENMARİ	
Toplam Güç:	1,5 kW
Kapasite	GN 1/1 X 100mm - 14 lt
Enerji Girişi	230 V 50-60 Hz
IZGARA	
Toplam Güç:	4,5 kW
Kapasite	530x385 mm <sup>2</sup>
Enerji Girişi	380 V 50-60 Hz
EVVE	
Kapasite	GN 1/2 x 200 mm - 60 lt.

COOKER	
Total Power	20 kW (5kW x 4pcs. / pr.)
Burner	5kW %62 efficiency
Inner Burner	0,8 kW (max) - 0,2 kW (min)
External Burner	4,2 kW (max) - 1,2 kW (min)
Usage Area	535x335 mms
Capacity	Ø 250 mm x 4 pots Ø 320 mm x 2 pots + Ø 180 mm x 2 pots
Gas Inlet	R 1/2" (30 mbar G30 / 20mbar G20)
INDUCTION WOK	
Total Power	5 kW
Capacity	Ø 300 mm wok pan
Power Inlet	380 V 50-60 Hz
FRYER	
Total Power	12 kW
Capacity	12 lt. oil / 1,5 kg potatoes
Power Inlet	380 V 50-60 Hz
PASTA COOKER	
Total Power	6 kW
Capacity	15 lt. water / 4 portion
Power Inlet	380 V 50-60 Hz
BAIN MARIE	
Total Power	1,5 kW
Capacity	GN 1/1 X 100mm - 14 lt
Power Inlet	230 V 50-60 Hz
GRILL	
Total Power	4,5 kW
Capacity	530x385 mm <sup>2</sup>
Power Inlet	380 V 50-60 Hz
SINK	
Capacity	GN 1/2 x 200 mm - 60 lt.

# INOSMART FIRINLAR

## INOSMART OVENS

Fırınlar ve Ekipmanları  
Ovens and Equipments



inosmart



# BUHAR JENERATÖRLÜ KOMBI FIRINLAR

COMBI STEAM OVEN



## Genel Özellikler:

- Tüm iç ve dış konstrüksiyon ve yüzeyler AISI 304 Cr-Ni paslanmaz çelik
- Yuvarlatılmış iç kabin konstrüksiyonu
- D.gaz & LPG & Elektrikli çalışma düzeni
- Dokunmatik veya dijital kontrol paneli
- 10 x GN 1/1 (10'luk fırınlarda) 10xGn 2/1 veya 20 x GN 1/1 (20'lik fırınlarda) 20xGN 2/1 veya 40 xGn 1/1 (40'lık fırınlarda) kapasiteli
- 400 x 600 mm. unlu mamül grubu tepsileri için özel iç kızak ve raf kiti
- Harici Buhar jeneratörlü (Boyerli sistem)
- Premix yanma sistemi (gazlı)
- Et Probu sistemi
- Turbo, buhar, kombi, ayarlanabilir buhar ve banket olan 5 pişirme modu
- İlave manuel kabin yıkama spreyi
- Hızlı soğutma sistemi
- Çift kademeli kapı kilit sistemi
- Kabin iç aydınlatma sistemi
- Yoğuşurma ünitesi
- İzolasyonlu çift cam kapı sistemi
- Aksesuarlar: Tepsi grupları, açık & kapalı & mayalamalı alt standlar, ara kapama kiti, davlumbazlar, tekerlekli tabak & tepsi arabaları, termal örtüler, unlu mamül kitleri

## General Features:

- It is completely manufactured from AISI304 18/8 CR-Ni
- Rounded internal cabin construction
- N.gas & LPG & Electric operated
- Touch or digital control panel
- 10 x GN 1/1 10 x GN 2/1 or 20 x GN 1/1 20xGN 2/1 or 40 xGn 1/1 capacity
- Special internal skid and shelf kit for 400 x 600 mm. bakery product group trays
- Steam generator (Boiler system)
- Premix burning system
- Probe system
- 5 baking modes, dry heat, steam, combi boiler, adjustable steam and banquette
- Additional manual cabin wash spray
- Fast cooling system
- Double-stage door lock system
- Cabin internal illumination system
- Quenching Unit
- Insulated double glass door system
- Accessories: Tray groups, open & closed & proofing sub-stands, space closure kit, hoods, plate & tray trolleys, thermal covers, bakery kits

## Dokunmatik Kontrol Panelli Fırında İlave Özellikler:

- Otomatik yıkama özelliği, 3 programlı
- Delta T ile pişirme özelliği
- 5 noktadan ölçümlü et probu sistemi
- 6 kademeli fan hızı
- 34 adet kayıtlı hazır pişirim reçetesi
- 86 adet pişirim reçetesi program kaydetme
- Favori pişirim reçetesi özelliği
- Gerçek zaman saati
- USB girişi ile reçete kopyalama ve software yükleme özelliği
- Buhar / Kuru sıcaklık ayarlama
- Enerji tasarrufu ve hassas ısı kontrolü (PID kontrol)
- Melodik sesli uyarı sistemi
- 4 farklı dil seçeneği
- Kolay kullanıcı paneli (easy GUI)
- Katlı (raflı) pişirme özelliği (Aynı pişirme modunda her raf için ayrı süre verilerek pişirme)
- Reçete içinde 6 fazlı adım girebilme
- Otomatik ön ısıtma seçeneği
- Kuru modda 5 kademeye kadar ayarlanabilen manuel nemlendirme özelliği
- Çift yöne dönenilen fırın içi hava dağıtım fanı bulunmaktadır. Ayrıca 40 tepsilik fırınlarda pişirme kabini içinde bulunan 2 adet kava dağıtım fanları, pişirim sırasında aynı yönde saat yönünde veya saat yönünün tersinde ve zıt yönlü olarak çalışarak homojen pişirim sağlamaktadır.
- Hata uyarı sistemi

## “Digital - W” Kontrol Panelli Fırında İlave Özellikler:

- Otomatik yıkama özelliği, 3 programlı
- Tek tuş döner buton ile tüm sistemin kontrolü
- Sıcaklık - zaman göstergesi
- 4 kademeli fan hızı
- Kuru modda anlık buhar verme
- Güncel değerler göstergesi
- Sesli uyarı sistemi
- 2 Farklı dil seçeneği
- Enerji tasarrufu ve hassas ısı kontrolü (PID / PWM kontrol)
- Hata uyarı sistemi

## Additional Features in Touch Control Panel:

- Automatic washing feature, 3-program
- Controlling all system with single key rotary button
- Feature of baking with Delta T
- Core (meat) probe system measuring from 5 points
- 6-stage fan speed
- 34 saved ready baking recipe
- Saving 86 baking recipe programs
- Feature of favorite baking recipe
- Real time clock
- Feature of recipe copying and software installing via USB socket
- Steam / Dry heat ratio tuning
- Energy saving and precision heat control (PID control)
- Melodic sound warning system
- 4 different language options
- Easy user panel (easy GUI)
- Stored (shelf) baking feature (baking by giving separate durations for each shelf)
- Capability of entering 6-phase steps during baking recipe
- Automatic pre-heating option
- Manual humidification feature adjustable up to 5 levels in dry mode
- Air distribution fan rotating in two directions are available. Also, cooking in 40-tray ovens 2 air distribution fans inside the cabin, clockwise in the same direction during firing or Working counterclockwise and in the opposite direction It provides homogeneous firing.
- Error warning system

## Additional Features in “Digital –W” Control Panel Oven

- Automatic wash feature, 3-program
- Controlling all system with single-key rotary button
- Heat - time indicator
- 4-stage fan speed
- Current spot values indicator
- Audio warning system
- 2 different language options
- Energy saving and precise heat control (PID/ PWM control)
- Error warning system



**inosmart**  
Convect

## KONVEKSİYONLU FIRINLAR

.....  
CONVECTION OVENS

### Genel Özellikler:

- Tüm iç ve dış konstrüksiyon ve yüzeyler AISI 304 Cr-Ni paslanmaz çelik
- Yuvarlatılmış iç kabin konstrüksiyonu
- D.gaz & LPG & Elektrikli çalışma düzeni
- Digital kontrol paneli – elektronik kumandalı
- 400 x 600 mm. unlu mamül grubu tepsileri için özel iç kızak ve raf kiti sistemi
- Sıcaklık – zaman göstergesi
- Manuel buhar özelliği
- Çift cam, izolasyonlu kapı sistemi
- Kabin iç aydınlatma sistemi
- Hızlı soğutma sistemi
- 6xGN 1/1 ( 6'lık fırınlarda) 10xGN 10 x GN 1/1 (10'lık fırınlarda) 10xGN 2/1 veya 20 x GN 1/1 (20'lik fırınlarda) 20xGN 2/1 veya 40 xGN 1/1 (40'lık fırınlarda) kapasiteli

### General Features:

- It is completely manufactured from AISI304 18/8 Cr-Ni
- Rounded internal cabin construction
- N.gas & LPG & Electric operated
- Digital control panel – electronic control
- Special internal skid and shelf kit system for 400 x 600 mm. bakery product group trays
- Heat – time indicator
- Manual steam feature
- Double glass, insulated door system
- Cabin internal illumination system
- Fast cooling system
- 6xGN 1/1 10 x GN 1/1 10 x GN 2/1 or 20 x GN 1/1 20xGN 2/1 or 40 xGN 1/1 capacity



**inosmart**  
Easycook

## SET ÜSTÜ FIRINLAR

.....  
COUNTER TOP OVENS

### Genel Özellikler:

- Digital veya manuel kontrol paneli
- Elektrikli çalışma düzeni
- 4 tepsi kapasiteli (Modele göre 600x400 - GN1/1 ya da 600x400-GN 2/3)
- 75 mm. tepsi arası mesafe
- Çift yöne dönüşlü 2 adet fanlı
- Çift cam, izolasyonlu kapı sistemi
- Emniyet sistemi

### General Features:

- Digital or manual control panel
- Electric operated
- 4 x 400 – 600 mm or 4 x GN 2/3 tray capacity
- 75 mm inter-tray distance
- Single & Double stage fan speed - two direction rotational
- Double glass, insulated door system
- Safety system

### Digital Kontrol Panelli Fırında İlave Özellikler:

- Otomatik ön ısıtma
- Pişirim esnasında 3 fazlı adım girebilme
- 99 program kayıt özelliği
- Otomatik nemlendirme özelliği
- Otomatik nemlendirmeye ilave buhar butonu

### Additional Features in Digital Control Panel Oven:

- Automatic pre-heating
- Capability of entering 3-phase steps during baking
- Saving 99 programmes
- Automatic humidification option
- Additional steam button to automatic humidification

### Manuel Kontrol Panelli Fırında İlave Özellikler:

- Sıcaklık ve zaman ayar butonu
- Manuel nemlendirme özelliği

### Additional Features in Manual Control Panel Oven:

- Heat and time adjustment knob
- Feature of manual humidification



Dijital W Kontrol Paneli  
Digital W Control Panel

INO-FBE40  
INO FBG040









INO-FBE10  
INO FBG010

INO-FBE20  
INO FBG020



MODEL	FIRIN TEPŞİ KAPASİTESİ	TEPŞİ TİPİ	GENİŞLİK	DERİNLİK	YÜKSEKLİK	MAX. ELEKTRİK GÜCÜ	MAX.GAZ GÜCÜ	ELEKTRİK GİRİŞİ	GAZ GİRİŞİ	SU BASINCI	NET AĞIRLIK
	TRAY CAPACITY	TRAY TYPE	WIDTH	DEPTH	HEIGHT	MAX.ELECTRIC POWER	MAX.GAS POWER	ELECTRIC INLET	GAS INLET	WATER PRESSURE	NET WEIGHT
	Adet Piece	Ölçü Size	mm	mm	mm	kW	kW	V	Inch	Bar	Kg
INO-FBG 040	20	GN 2/1	1180	1070	1893	3	50	220-230 V AC / 1N / 50Hz	3/4"	2-4	350
INO-FBG 020	10	GN 2/1	1180	1070	1190	1,1	25	220-230 V AC / 1N / 50Hz	3/4"	2-4	250
INO-FBG 010	10	GN 1/1	925	793	1190	1,1	15	220-230 V AC / 1N / 50Hz	3/4"	2-4	190
INO-FBE 40	20	GN 2/1	1180	1070	1893	50+2	-	380-400V AC / 3N / 50 Hz		2-4	350
INO-FBE 20	10	GN 2/1	1180	1070	1190	25+1	-	380-400V AC / 3N / 50 Hz		2-4	250
INO-FBE 10	10	GN 1/1	925	793	1190	17,5+1	-	380-400V AC / 3N / 50 Hz		2-4	190

 Dokunmatik Kontrol Panelli  
 Touch Control Panel

MODEL	FIRIN TEPSİ KAPASİTESİ	TEPSİ TİPİ	GENİSLİK	DERİNLİK	YÜKSEKLİK	MAX. ELEKTRİK GÜCÜ	MAX.GAZ GÜCÜ	ELEKTRİK GİRİŞİ	GAZ GİRİŞİ	SU BASINCI	NET AĞIRLIK
	TRAY CAPACITY	TRAY TYPE	WIDTH	DEPTH	HEIGHT	MAX.ELECTRIC POWER	MAX.GAS POWER	ELECTRIC INLET	GAS INLET	WATER PRESSURE	NET WEIGHT
	Adet Piece	Ölçü Size	mm	mm	mm	kW	kW	V	Inch	Bar	Kg
 INO-FBG 40T	20	GN 2/1	1180	1070	1895	3	50	220-230 V AC / 1N / 50Hz	3/4"	2-4	350
 INO-FBG 20T	10	GN 2/1	1180	1070	1190	1,1	25	220-230 V AC / 1N / 50Hz	3/4"	2-4	250
 INO-FBG 10T	10	GN 1/1	925	793	1190	1,1	15	220-230 V AC / 1N / 50Hz	3/4"	2-4	190
 INO-FBE 40T	20	GN 2/1	1180	1070	1893	50+2	-	380-400V AC / 3N / 50 Hz		2-4	350
 INO-FBE 20T	10	GN 2/1	1180	1070	1190	25+1	-	380-400V AC / 3N / 50 Hz		2-4	250
 INO-FBE 10T	10	GN 1/1	925	793	1190	17,5+1	-	380-400V AC / 3N / 50 Hz		2-4	190



AÇIK STAND  
OVEN BASE / OPEN

**INO-FGA101 / INO-FGA201**



ARA KAPAMA BAZASI  
KICKING STRIP FOR  
INTERVAL CLOSURE

**2022140140  
2022140150**



TEPSİ İSTİF ÜNİTESİ  
TRAY LOADING  
UNIT

**INO-FKA011I / 2022103200**



TEPSİ TAŞIMA  
ARABASI  
TRAY CARRYING UNIT

**INO-FKA011T / INO-FKA021T**



INO-FKA011T / INO-FKA011I ve  
INO-FKA021T / 2022103200 birleşimi  
FKA011T / FKA011I and  
FKA021T / FKA021I



TEPSİ ARABA  
İSTİF KIZAK KİTİ  
ROLL-IN TRAY KIT

**2022132090  
2022100220**



MODEL	FIRIN TEPSİ KAPASİTESİ TRAY CAPACITY	TEPSİ TİPİ TRAY TYPE	NET AĞIRLIK WEIGHT
	Adet / Piece	Ölçü / Size	Kg
INO-FGA101	10	GN 1/1	45
INO-FGA201	GN1/1x15 veya/or GN1/1x5 + GN2/1x5	GN1/1 ve/and GN2/1	65
2022140140	-	-	5
2022140150	-	GN 2/1	8
INO-FKA011I	10	GN 1/1	12
2022103200	10	GN 2/1	15
INO-FKA011T	-	-	35
INO-FKA021T	-	GN 2/1	40
2022132090	-	-	5
2022100220	-	-	5



**2022114301**

**TEPSİ TAŞIMA ARABASI**  
**TRAY CARRYING UNIT**



**2022114400**

**TABAK TAŞIMA ARABASI**  
**OVEN PLATE TROLLEY**



**INO-FGM 101**  
**INO-FGM 201**

**MAYALAMA DOLABI**  
**PROOFER CABINET**



**2022131690**  
**2022101590**

**400 X 600 MM İÇİN**  
**TEPSİ İÇ KİTİ**  
**KIT FOR**  
**400\*600 MM TRAYS**



**2022140310**  
**2022140320**

**DAVLUMBAZ**  
**EXHAUST HOOD**



MODEL	FIRIN TEPSİ KAPASİTESİ	TEPSİ TİPİ	NET AĞIRLIK
	TRAY CAPACITY	TRAY TYPE	WEIGHT
	Adet Piece	Ölçü Size	Kg
2022114301	20	GN 2/1	45
2022114400	20	GN 2/1	45
INO-FGM101	GN1/1x10 veya/or 40x60cm 5	GN1/1 ve/and 400x600	105
INO-FGM201	GN1/1x15 veya GN1/1x5+ GN2/1x5 veya/or 40*60cm 10	400x600	120
2022131690	8	400 x 600	5
2022101590	8	400x600	5
2022140310	-	-	45
2022140320	-	-	60





Dijital Kontrol Paneli  
Digital Control Panel



MODEL	FIRIN TEPSİ KAPASİTESİ	TEPSİ TİPİ	GENİŞLİK	DERİNLİK	YÜKSEKLİK	MAX. ELEKTRİK GÜCÜ	MAX. GAZ GÜCÜ	ELEKTRİK GİRİŞİ	GAZ GİRİŞİ	SU BASINCI	NET AĞIRLIK
	TRAY CAPACITY	TRAY TYPE	WIDTH	DEPTH	HEIGHT	MAX. ELECTRIC POWER	MAX. GAS POWER	ELECTRIC INLET	GAS INLET	WATER PRESSURE	NET WEIGHT
	Adet Piece	Ölçü Size	mm	mm	mm	kW	kW	V	Inch	Bar	Kg
INO-FKE 06	6	GN1/1	925	793	930	10+1	-	380-400V AC / 3N / 50 Hz	-	2-4	116
INO-FKE 10	10	GN1/1	925	793	1190	15+1	-	380-400V AC / 3N / 50 Hz	-	2-4	144
INO-FKE 20	10	GN 2/1	1180	1070	1190	25+1	-	380-400V AC / 3N / 50 Hz	-	2-4	231
INO-FKE 40	20	GN 2/1	1180	1070	1893	50+2	-	380-400V AC / 3N / 50 Hz	-	2-4	313



Dijital Kontrol Panelli  
Digital Control Panel

INO-FKG40



INO-FKG20



INO-FKG10



MODEL	FIRIN TEPŞİ KAPASİTESİ	TEPŞİ TİPİ	GENİŞLİK	DERİNLİK	YÜKSEKLİK	MAX. ELEKTRİK GÜCÜ	MAX.GAZ GÜCÜ	ELEKTRİK GİRİŞİ	GAZ GİRİŞİ	SU BASINCI	NET AĞIRLIK
	TRAY CAPACITY	TRAY TYPE	WIDTH	DEPTH	HEIGHT	MAX.ELECTRIC POWER	MAX.GAS POWER	ELECTRIC INLET	GAS INLET	WATER PRESSURE	NET WEIGHT
	Adet Piece	Ölçü Size	mm	mm	mm	kW	kW	V	Inch	Bar	Kg
INO-FKG40	20	GN2/1	1180	1175,6	1893	2,4	50	220-230V / 1N 50Hz	3/4"	2-4	313
INO-FKG20	10	GN2/1	1180	1174	1190	1,1	25	220-230V / 1N 50Hz	3/4"	2-4	231
INO-FKG10	10	GN1/1	1180	896	1190	1,1	15	220-230V / 1N 50Hz	3/4"	2-4	144



**INO-FGA101 / INO-FGA201**

AÇIK STAND  
OVEN BASE / OPEN



**2022140140  
2022140150**

ARA KAPAMA BAZASI  
KICKING STRIP FOR  
INTERVAL CLOSURE



**INO-FKA011T / INO-FKA021T**

TEPSİ TAŞIMA  
ARABASI  
TRAY CARRYING UNIT



**INO-FKA011I / 2022103200**

TEPSİ İSTİF ÜNİTESİ  
TRAY LOADING  
UNIT



**2022132090  
2022100220**

TEPSİ ARABA  
İSTİF KIZAK KİTİ  
ROLL-IN TRAY KIT



INO-FKA011T / INO-FKA011I ve  
INO-FKA021T / 2022103200 birleşimi  
FKA011T / FKA011I and  
FKA021T / FKA021I

MODEL	FIRIN TEPSİ KAPASİTESİ	TEPSİ TİPİ	NET AĞIRLIK
	TRAY CAPACITY	TRAY TYPE	NET WEIGHT
	Adet / Piece	Ölçü / Size	Kg
INO-FGA101	10	GN 1/1	45
INO-FGA201	GN1/1x1 veya/or GN1/1x5 + GN2/1x5 a	GN1/1 ve/and GN2/1	65
2022140140	-	-	5
2022140150	-	GN 2/1	8
INO-FKA011T	-	-	35
INO-FKA021T	-	GN 2/1	40
INO-FKA011I	10	GN 1/1	12
2022103200	10	GN 2/1	15
2022132090	-	-	5
2022100220	-	-	5



Dijital Kontrol Paneli  
Digital Control Panel

INO-FKE042 / INO-FKG042E









INO-FKE 006



INO-FKE 010



INO-FKE022 / INO-FKG022E

MODEL	FIRIN TEPESİ KAPASİTESİ	TEPESİ TİPİ	GENİŞ.	DERİN.	YÜKSEK.	ELEKTRİK GÜCÜ	GAZ GÜCÜ	ELEKTRİK GİRİŞİ	GAZ GİRİŞİ	SU BASINCI	NET AĞIRLIK
	TRAY CAPACITY	TRAY TYPE	WIDTH	DEPTH	HEIGHT	ELECTRIC POWER	GAS POWER	ELECTRIC INLET	GAS INLET	WATER PRESSURE	NET WEIGHT
	Adet / Piece	Ölçü / Size	mm	mm	mm	kW	kW	V	Inch	Bar	Kg
 INO-FKE 006	6	GN1/1	980	880	760	10	-	380-400V AC / 3N / 50 Hz	-	2-4	127
 INO-FKE 010	10	GN1/1	980	880	980	14,5	-	380-400V AC / 3N / 50 Hz	-	2-4	147
 INO-FKE 022	10	GN 2/1	1200	1105	1630	19	-	380-400V AC / 3N / 50 Hz	-	2-4	230
 INO-FKE 042	20	GN 2/1	1200	1105	1630	38	-	380-400V AC / 3N / 50 Hz	-	2-4	330
 INO-FKG 022E	10	GN 2/1	1200	1105	1610	1,1	24	220-230 V AC / 1N / 50Hz	3/4"	2-4	245
 INO-FKG 042E	20	GN 2/1	1200	1105	1650	2	36	220-230 V AC / 1N / 50Hz	3/4"	2-4	345

**INO-FGA100**

6 ve 10 tepsili fırınlar içindir.  
For 6 and 10 trays ovens.

AÇIK STAND  
OVEN BASE / OPEN

**INO-FGM100**

MAYALAMA KABİNİ  
PROOFER CABINET

**2022103200**

TEPSİ İSTİF ÜNİTESİ  
TRAY LOADING UNIT

**INO-FKA020T**

TEPSİ TAŞIMA ARABASI  
TRAY CARRYING UNIT

**2022113200**

TEPSİ İSTİF ÜNİTESİ  
TRAY LOADING UNIT

**INO-FKA040T**

TEPSİ TAŞIMA ARABASI  
TRAY CARRYING UNIT



MODEL	FIRIN TEPSİ KAPASİTESİ	TEPSİ TİPİ	NET AĞIRLIK
	TRAY CAPACITY	TRAY TYPE	NET WEIGHT
	Adet / Piece	Ölçü / Size	Kg
INO-FGA100	6 / 10	GN 1/1	50
INO-FGM100	6 / 10	GN 1/1	73
2022103200	10	GN 2/1	15
INO-FKA020T	10	GN 2/1	27
2022113200	20	GN 2/1	23
INO-FKA040T	20	GN 2/1	21

2015300002  
2015300001  
2015300011



GASTRONOM KÜVET  
GN CONTAINER



2015300008 (20mm)  
2015300021 (40mm)  
2015300004 (65mm)



HAŞLAMA İÇİN  
DELİKLİ KÜVET  
S/S BOILING TRAY



2015300010  
2015300013  
2015300020



GASTRONOM KÜVET  
GN CONTAINER



2015300903



TEFLON KAPLAMALI  
TEPSİ / ALTI DELİKLİ  
TEFLON COATED TRAY FLAT



2015300902



BAGET İÇİN  
DELİKLİ TEPŞİ  
BAGUETTE TRAY PERFORATED



2022133040



PASLANMAZ ÇELİK TEL RAF  
S/S WIRE SHELF



2015300901



KIZARTMA SEPETİ  
FRYING TRAY



2015300900



KIZARTMA SEPETİ  
FRYING TRAY



MODEL	TEPSİ TİPİ	YÜKSEKLİK
	TRAY TYPE	HEIGHT
	Ölçü / Size	mm
2015300002	GN 1/1	20
2015300001	GN 1/1	40
2015300011	GN 1/1	65
2015300010	GN 1/1	20
2015300013	GN 1/1	40
2015300020	GN 1/1	65
2015300008	GN 1/1	20
2015300021	GN 1/1	40
2015300004	GN 1/1	65
2015300903	GN 1/1	20
2015300902	400 x 600	-
2022133040	GN 1/1	-
2015300900	GN 1/1	-
2015300901	GN 2/1	-



PIR-PF7604



PIR-PF6004



PIR-PF7604D



PIR-PF6004D

MODEL	KONTROL	FIRIN TEPSİ KAPASİTESİ	TEPSİ TİPİ	GENİŞLİK	DERİNLİK	YÜKSEKLİK	ISI KAPASİTESİ	ELEKTRİK GİRİŞİ	NET AĞIRLIK
	CONTROL	TRAY CAPACITY	TRAY TYPE	WIDTH	DEPTH	HEIGHT	HEAT CAP.	ELECTRIC INLET	NET WEIGHT
		Adet Piece	Ölçü Size	mm	mm	mm	kW	V	Kg
PIR-PF6204	Manuel	4	442 x 325 - GN 2/3	600	680	540	3,1	230 V	37
PIR-PF7604	Manuel	4	600 x 400 - GN 1/1	750	720	540	6,3	230 / 400 V	55
PIR-PF6204D	Dijital	4	442 x 325 - GN 2/3	600	680	540	3,1	230 V	37
PIR-PF7604D	Dijital	4	600 x 400 - GN 1/1	750	720	540	6,3	230 / 400 V	55



PIR-PS6095

STAND



PIR-PS7595

STAND



MODEL	AÇIKLAMA
	FEATURES
	Adet / Piece
PIR-PS6095	Stand / Kapasite: 7 tepsi / Kullanılan fırın: PF6004, PF6004D / 600x600x950 (WxDxH) / Ağırlık: 19 kg. Stand / Capacity: 7 tray / Oven: PF6004, PF6004D / 600x600x950 (WxDxH) / Weight: 19 kg.
PIR-PS7595	Stand / Kapasite: 8 tepsi / Kullanılan fırın: PF7604, PF7604D / 800x650x950 (WxDxH) / Ağırlık: 24 kg. Stand / Capacity: 8 tray / Oven: PF7604, PF7604D / 800x650x950 (WxDxH) / Weight: 24 kg.

---

# PIZZA FIRINLARI

.....  
PASTRY AND PIZZA  
OVENS



**INT-SG0004**

 PİZZA FIRINI  
PIZZA OVEN

MODEL	GENİŞLİK	DERİNLİK	YÜKSEKLİK	İÇ ÖLÇÜLER	TOPLAM GÜÇ	PIZZA KAPASİTESİ	PIŞİRME KATI	NET AĞIRLIK
	WIDTH	DEPTH	HEIGHT	INTERNAL DIMENSIONS	TOTAL POWER	PIZZA CAP.	COOKING DECK	NET WEIGHT
	cm	cm	cm	cm	kW	Adet / pcs.	Adet / pcs.	Kg
INT-SG0004	122	114	78	92x92x14	16kW 240/400V - 3 F+N	9+9 ( 30cm)	2	245

**INT-SG0036**

 PİZZA FIRINI  
PIZZA OVEN

**INT-SG0005**

 PİZZA FIRINI  
PIZZA OVEN

MODEL	GENİŞLİK	DERİNLİK	YÜKSEKLİK	İÇ ÖLÇÜLER	TOPLAM GÜÇ	PIZZA KAPASİTESİ	PIŞİRME KATI	NET AĞIRLIK
	WIDTH	DEPTH	HEIGHT	INTERNAL DIMENSIONS	TOTAL POWER	PIZZA CAP.	COOKING DECK	NET WEIGHT
	cm	cm	cm	cm	kW	Adet / pcs.	Adet / pcs.	Kg
INT-SG0046	122	82	78	92x62x14	12kW 240/400V - 3 F+N	6+6 (Ø30 cm)	2	195
INT-SG0040	92	114	78	62x92x14	12kW 240/400V - 3 F+N	6+6 (Ø30 cm)	2	195
INT-SG0042	96	84	78	68x68x14	10kW 240/400V - 3 F+N	4+4 (Ø33 cm)	2	155
INT-SG0038	92	82	78	62x62x14	10kW 240/400V - 3 F+N	4+4 (Ø30 cm)	2	144
INT-SG0036	80	72	50	50x50x10	6kW 240/400V - 3 F+N	4+4 (Ø25 cm)	2	73
INT-SG0005	122	114	44	92x92x14	8kW 240/400V - 2 F+N	9 (Ø30cm)	1	140
INT-SG0047	122	82	44	92x62x14	6kW 240/400V - 2 F+N	6 (Ø30 cm)	1	102
INT-SG0041	92	114	44	62x92x14	6kW 240/400V - 2 F+N	6 (Ø30 cm)	1	102
INT-SG0043	96	84	44	68x68x14	5kW 240/400V - 2 F+N	4 (Ø33 cm)	1	85
INT-SG0039	92	82	44	62x62x14	5kW 240/400V - 2 F+N	4 (Ø30 cm)	1	75
INT-SG0037	80	72	39	50x50x10	4kW 240/400V - 2 F+N	4 (Ø25 cm)	1	56

**INT-SG**

KONVEYÖRLÜ PİZZA, PİDE, LAHMACUN FIRINI  
CONVEYOR PIZZA, FLAT BREAD OVEN



MODEL	GENİŞLİK	DERİNLİK	YÜKSEKLİK	İÇ ÖLÇÜ	TOPLAM GÜÇ	PİŞİRME ZAMANI	PİŞİRME KATI	NET AĞIRLIK
	WIDTH	DEPTH	HEIGHT	INTERNAL DIMENSIONS	TOTAL POWER	COOKING TIME	COOKING DECK	NET WEIGHT
	mm	mm	mm	mm	kW	Dk / Min.	Adet / Pcs	Kg
INT-SG0050	1700	1100	1000	720x500	10 kW -400/50 Hz. -3F+N	Lahmacun 3 Pide / Flat Bread 4 Pizza 5-6	1	160
INT-SG0051	1700	1100	1000	720x500	13 kW - 230V/50 Hz.	Lahmacun 3 Pide / Flat Bread 4 Pizza 5-6	1	165
INT-SG0048	1700	1100	1450	720x500	10 kWx2 -400/50 Hz. -3F+N	Lahmacun 3 Pide / Flat Bread 4 Pizza 5-6	2	290
INT-SG0049	1700	1100	1450	720x500	13 kWx2 - 230V/50 Hz.	Lahmacun 3 Pide / Flat Bread 4 Pizza 5-6	2	350

**INT-SG**
**PİZZA, PİDE, LAHMACUN FIRINI  
PIZZA, FLAT BREAD OVEN**

MODEL	GENİŞLİK	DERİNLİK	YÜKSEKLİK	ALT BAZA	İÇ ÖLÇÜ	TOPLAM GÜÇ	PIŞİRME KAPASİTESİ	PIŞİRME KATI	NET AĞIRLIK
	WIDTH	DEPTH	HEIGHT	SUB-BASE	INTERNAL DIMENSION	TOTAL POWER	PIZZA CAP.	COOKING DECK	NET WEIGHT
	mm	mm	mm		mm	kW	Adet / pcs.	Adet / Pcs	Kg
INT-SG0002	1350	950	1480	Standlı With Stand	1050x700x1400	9,5 kW -400V 3F+N	6	1	205
INT-SG0001	1530	950	1280	Standlı With Stand	1050x700x1400 (2 Katlı / Layer)	9,5 kWx2 -400V 3F+N	6+6	2	315
INT-SG0003	1350	950	1840	Mayalamalı With Proofer	1050x700x1400 (3 Katlı / Layer)	9,5 kWx3 -400V 3F+N 3kW/220-240V Mayalama Dolabı	6+6+6	3	450

**INT-SG0020**
**PİZZA FIRINI  
PIZZA OVEN**

Tek Kat + Tezgah + Davlumbaz  
Single Deck + Stand + Hood

INT-SG0020	
Kapasite Capacity	40*60*4 ad./pcs. tava / pan / 40*80*3 ad./pcs. tava / pan 40*40*6 ad./pcs tava / pan Ø 40 * 6 ad./pcs tava/ pan
Dış Ölçü External Dimension	1600x1020x1500 mm
Güç / Power	13.3 kw 400W
İç Ölçü Internal Dimension	124x84x18 cm
Tezgah Boyu Stand Dimension	160x90x90 cm
Ağırlık Weight	360 Kg

**INT-SG0022**
**PİZZA FIRINI  
PIZZA OVEN**

Tek Kat + Mayalamalı + Davlumbaz  
Single Deck + Proofer + Hood

INT-SG0022	
Kapasite Capacity	40*60*4 ad./pcs tava/ pan 40*80*3 ad./pcs tava/ pan 40*40*6 ad./pcs tava/ pan Ø 40 * 6 ad./pcs tava/ pan
Dış Ölçü External Dimension	1600x1020x1500 mm
Güç / Power	13.3 kw 400W
İç Ölçü Internal Dimension	124x84x18 cm
Mayalama Boyu Proofer Dimension	160x100x90 cm
Ağırlık Weight	390 Kg

**INT-SG0016**
**PİZZA FIRINI  
PIZZA OVEN**

2 Kat + Tezgah + Davlumbaz  
Double Deck + Stand + Hood

INT-SG0016	
Kapasite Capacity	40*40*6 ad./pcs tava/ pan / kat / deck Ø 40 * 6 ad./pcs tava/ pan / kat/ deck 40*60 *4 ad./pcs tava/ pan/ kat./ deck 40*80*3 ad./pcs tava/ pan / kat/ deck
Dış Ölçü External Dimension	1600x1020x1720 mm
Güç / Power	26,5 Kw 400V 3N
İç Ölçü Internal Dimension	124x84x18 cm
Tezgah Boyu Stand Dimension	160x90x90 cm
Ağırlık Weight	470 Kg

**INT-SG0017**
**PİZZA FIRINI  
PIZZA OVEN**

2 Kat + Mayalamalı + Davlumbaz  
Double Deck + Proofer + Hood

**INT-SG0027**
**PİZZA FIRINI  
PIZZA OVEN**

3 Kat + Mayalamalı + Davlumbaz  
Triple Deck + Proofer + Hood

**INT-SG0055**
**PİZZA FIRINI STANDI  
PIZZA OVEN STAND**

INT-SG0017	
Kapasite Capacity	40*60*4 ad./pcs tava/ pan / kat / deck 40*80*3 ad./pcs tava/ pan / kat / deck 40*40*6 ad./pcs tava/ pan / kat / deck Ø 40 * 6 ad./pcs tava/ pan / kat / deck
Dış Ölçü External Dimension	1660x1020x1840 mm
Güç / Power	26,5 kw 400W
İç Ölçü Internal Dimension	124x84x18 cm
Mayalama Boyu Proofer Dimension	160x100x90 cm
Ağırlık Weight	500 Kg

INT-SG0027	
Kapasite Capacity	40*60*4 ad./pcs tava/ pan / kat / deck 40*80*3 ad./pcs tava/ pan / kat / deck 40*40*6 ad./pcs tava/ pan / kat / deck Ø 40 * 6 ad./pcs tava/ pan / kat / deck
Dış Ölçü External Dimension	1600x1020x1500 mm
Güç / Power	45 kw 400W
İç Ölçü Internal Dimension	124x84x18 cm
Mayalama Boyu Proofer Dimension	160x100x55 cm
Ağırlık Weight	700 Kg

MODEL	İÇ ÖLÇÜLER INTERNAL DIMENSIONS
	cm
	80x64x85
INT-SG0056	92x72,5x85
INT-SG0057	92x102x85
INT-SG0058	98x78,5x85
INT-SG0060	122x72,5x85
INT-SG0061	122x102x85
INT-SG0054	130x78,5x85

**INT-SG0007 / BUHAR BOYLERİ İLAVE / STEAM GENERATOR**

ME-MD-MT Fırınlar için / For ME-MD-MT Ovens

# MİKRODALGA FIRINLAR

.....

MICROWAVE OVENS



**GAL-MDF90W25L**
**MİKRODALGA FIRIN  
MICROWAVE OVEN**

GAL-GMD239DAH-S	
Mikrodalga gücü / Microwave Power	900 W
Izgara gücü / Grill Power	1000 W
İç kabin hacmi / Inside Volume	25 Lt
Mikrodalga fırın ve ızgara kombinasyonu / Microwave / Grill Combination	✓
Zaman ayarlı / Time Control	✓
10 mikrodalga güç seviyesi / 10 Microwave Power Level	✓
3 kombine (mikrodalga/ızgara) pişirme ısı ayarı / 3 combination (microwave/grill) cooking heat setting	✓
270 mm döner cam tabla / 270 mm turntable glass plate	✓
(W) x (D) x (H) mm	547 x 436 x 337 mm

# DÖNER OCAKLARI

## DONER KEBAP MACHINES

### Set Üstü Pişiriciler Worktop Units



- Döner ocakları AISI 304 Cr-Ni paslanmaz çeliktir.
- Döner ocaklarında 1 devir/dakika ısı yalıtımlı, yüksek performanslı motorlar kullanılmaktadır.
- Döner ocaklarında kullanıcının sağ ve sol el kullanması durumunda et dönüş yönünü değiştirmeye yarayan şalter mevcuttur.
- 1 adet şiş, 1 adet kürek, 1 adet yağ tepsisi, 1 adet firkete ile satışa sunulmuştur.
- Döner ocakları şişin eğik şekilde çalışabilmesine imkan verecek şekilde dizayn edilmiştir.
- Döner ocaklarında kesilen etlerin yere düşmesini engellemek için geniş yağ toplama tepsileri bulunmaktadır. Yağ tepsilerine akan yağların süzülmesi ve etlerin aşırı yağlanmaması için süzgeç sacı bulunmaktadır.
- Gerekğinde tüm ısıtıcılar tek tek değiştirilebilir.
- Cihazlar tablolarda belirtilen gaz ve elektrik değerleri ile devreye alınmalıdır. Isıtıcılara asla su sıçratılmamalıdır.
- Cihaz çalıştırılırken arka ve yanlarda 25 cm boşluk bırakılmalıdır.
- Cihaz her gün iş bitiminde ılık sabunlu bez ile silinmeli ve kurulanmalıdır.
- Cihazın ortama duman ve koku yaymaması için uygun havalandırmalı bir davlumbaz altına konulmasını tavsiye ederiz.
- All devices and equipment are manufactured from AISI304 grade 18/8 Cr/Ni stainless steel.
- 1 Rpm, high-performance and heat-isolated motors.
- Meat turning direction selector switch ensures easiness for left and right hand cut.
- All machines delivered with 1 skewer, 1 shovel, 1 fat tray and 2 fixing pins.
- Machines are designed to ensure inclined cut of the meat.
- Each machine has a large tray to collect much fat and prevent dripping of sliced meat. Each tray has a perforated plate in order to hide fat.
- Each heater can be replaced separately.
- Machines must be switched according to values of gas and electric shown in user manual. Heaters must be strictly avoided from water splashing.
- Machine must be running with 25cm gap at the back and sides.
- Machine must be cleaned with warm soupy cloth and dried at the end of every working day.
- Machine must be placed under hood to keep away from smoke and smell.

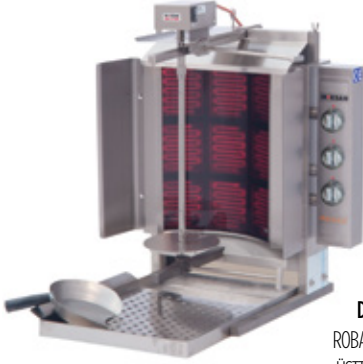

**DÖNER OCAĞI**  
ROBAX CAMLI 3'LÜ  
ÜSTTEN MOTORLU  
**DONER KEBAB MACHINE**  
WITH ROBAX GLASS / MOTOR ON THE  
TOP / 3 LEVELS

**INO-PDE 303E**

**DÖNER OCAĞI**  
ROBAX CAMLI 4'LÜ  
ÜSTTEN MOTORLU  
**DONER KEBAB MACHINE**  
WITH ROBAX GLASS / MOTOR ON THE  
TOP / 4 LEVELS

**INO-PDE 403E**

**DÖNER OCAĞI**  
ROBAX CAMLI 5'Lİ  
ÜSTTEN MOTORLU  
**DONER KEBAB MACHINE**  
WITH ROBAX GLASS / MOTOR ON THE  
TOP / 5 LEVELS

**INO-PDE 503E**

MODEL	GENİŞLİK	DERİNLİK	YÜKSEKLİK	FAYDALI ŞİŞ BOYU	ISI KAP.	DÖNER KAP.	GERİLİM	N. AĞIRLIK
	WIDTH	DEPTH	HEIGHT	SKEWER LENGTH	HEAT CAP.	MEAT CAP.	POWER	N.WEIGHT
	mm	mm	mm	mm	kW	Kg	V	Kg
INO-PDE 303E	608	598	855	480	5.4	45-60	380-400V/3N/AC/50-60 Hz	30
INO-PDE 403E	608	598	1005	600	7.2	60-75	380-400V/3N/AC/50-60 Hz	34
INO-PDE 503E	608	598	1151	750	9	75-90	380-400V/3N/AC/50-60 Hz	41



**DÖNER OCAĞI**  
ROBAX CAMLI 3'LÜ  
ALTAN MOTORLU  
**DONER KEBAB MACHINE**  
WITH ROBAX GLASS / MOTOR AT THE  
BOTTOM / 3 LEVELS

**INO-PDE 303**

**DÖNER OCAĞI**  
ROBAX CAMLI 4'LÜ  
ALTAN MOTORLU  
**DONER KEBAB MACHINE**  
WITH ROBAX GLASS / MOTOR AT THE  
BOTTOM / 4 LEVELS

**INO-PDE 403**

**DÖNER OCAĞI**  
ROBAX CAMLI 5'Lİ  
ALTAN MOTORLU  
**DONER KEBAB MACHINE**  
WITH ROBAX GLASS / MOTOR AT THE  
BOTTOM / 5 LEVELS

**INO-PDE 503**

MODEL	GENİŞLİK	DERİNLİK	YÜKSEKLİK	FAYDALI ŞİŞ BOYU	ISI KAP.	DÖNER KAP.	GERİLİM	N. AĞIRLIK
	WIDTH	DEPTH	HEIGHT	SKEWER LENGTH	HEAT CAP.	MEAT CAP.	POWER	N.WEIGHT
	mm	mm	mm	mm	kW	Kg	V	Kg
INO-PDE 303	632	772	860	480	5.4	45-60	380-400V/3N/AC/50-60 Hz	40
INO-PDE 403	632	772	982	600	7.2	60-75	380-400V/3N/AC/50-60 Hz	46
INO-PDE 503	632	772	1132	750	9	75-90	380-400V/3N/AC/50-60 Hz	51



**DÖNER OCAĞI**  
ROBAX CAMLI, 6 RADYANLI,  
ALTAN MOTORLU  
**DONER KEBAB MACHINE**  
WITH ROBAX GLASS / MOTOR AT THE  
BOTTOM / 6 RADIANTS

**INO-PDG 300**



**DÖNER OCAĞI**  
ROBAX CAMLI, 8 RADYANLI,  
ALTAN MOTORLU  
**DONER KEBAB MACHINE**  
WITH ROBAX GLASS / MOTOR AT THE  
BOTTOM / 8 RADIANTS

**INO-PDG 400**



**DÖNER OCAĞI**  
ROBAX CAMLI, 10 RADYANLI,  
ALTAN MOTORLU  
**DONER KEBAB MACHINE**  
WITH ROBAX GLASS / MOTOR AT THE  
BOTTOM / 10 RADIANTS

**INO-PDG 500**



MODEL	GENİŞ.	DER.	YÜKS.	FAYDALI ŞİŞ BOYU	ISIKAP.	DÖNER KAP.	GAZ GİR.	GAZ BASINCI	GERİLİM	N. AĞIRLIK	
	WIDTH	DEPTH	HEIGHT	SKEWER LENGTH	HEAT CAP.	MEAT CAP.	GAS INLET	GAS PRESSURE	POWER	N.WEIGHT	
	mm	mm	mm	mm	kW	Kg	Inch	LPG (G30/3)	NG (G20/25)	V	Kg
INO-PDG 300	661	764	831	480	12	45-60	1/2"	30/50 mbar	20/25 mbar	220-230V/50-60 Hz	45
INO-PDG 400	661	764	981	600	16	60-75	1/2"	30/50 mbar	20/25 mbar	220-230V/50-60 Hz	52
INO-PDG 500	661	764	1131	750	20	75-90	1/2"	30/50 mbar	20/25 mbar	220-230V/50-60 Hz	61



**DÖNER OCAĞI**  
3 RADYANLI,  
ALTAN MOTORLU  
**DONER KEBAB MACHINE**  
MOTOR AT THE BOTTOM / 3 RADIANTS

**INO-PDG303**



**DÖNER OCAĞI**  
4 RADYANLI,  
ALTAN MOTORLU  
**DONER KEBAB MACHINE**  
MOTOR AT THE BOTTOM / 4 RADIANTS

**INO-PDG 403**



**DÖNER OCAĞI**  
4 RADYANLI,  
ALTAN MOTORLU  
**DONER KEBAB MACHINE**  
MOTOR AT THE BOTTOM / 4 RADIANTS

**INO-PDG 503**



MODEL	GENİŞ.	DER.	YÜKS.	FAYDALI ŞİŞ BOYU	ISIKAP.	DÖNER KAP.	GAZ GİR.	GAZ BASINCI	GERİLİM	N. AĞIRLIK	
	WIDTH	DEPTH	HEIGHT	SKEWER LENGTH	HEAT CAP.	MEAT CAP.	GAS INLET	GAS PRESSURE	POWER	N.WEIGHT	
	mm	mm	mm	mm	kW	Kg	Inch	LPG (G30/3)	NG (G20/25)	V	Kg
INO-PDG 303	556	764	915	540	9	45-60	1/2"	30/50 mbar	20/25 mbar	220-230V/50-60 Hz	44
INO-PDG 403	556	764	1071	690	12	60-75	1/2"	30/50 mbar	20/25 mbar	220-230V/50-60 Hz	47
INO-PDG 503	561	764	1238	790	15	75-90	1/2"	30/50 mbar	20/25 mbar	220-230V/50-60 Hz	55

**INT-KK0021**

**ROBOİNOKS ROBOTLU DÖNER OCAĞI  
AUTOMATIC DONER KEBAB MACHINE**

MODEL	ADI	ÖLÇÜ	ISI KAP.	TOPLAM	DÖNER KAP.	ŞİŞ BOYU	AĞIRLIK
	DESCRIPTION	DIMENSIONS	HEAT CAP.	TOTAL	MEAT CAP.	SKEWER HEIGHT	N.WEIGHT
		mm	kW	kW	Kg	Inch	Kg
INT-KK0021	Döner Robotu,PDE503 ERR, ELK. PDE503ERR/L, Electric, TOUCH SCREEN CONTROL with Bainmarie	780x930x1291	10,5	9,35	120	750	170
INT-KK0023	Döner Robotu,PDG500RR Gazlı PDG500RR/L, Gas, TOUCH SCREEN CONTROL with Bainmarie	780x930x1291	20	20,35	120	750	166
INT-KK0044	Döner Robotu,PDE403ERR, ELK. Benmarili PDE403ERR/L, Electric, TOUCH SCREEN CONTROL with Bainmarie	780x930x1291	7,3	10,1	80	630	166
INT-KK0046	Döner Robotu,PDG400RR, Gazlı, Benmarili PDG400RR/L, Gas, TOUCH SCREEN CONTROL with Bainmarie	780x930x1291	16	21,1	80	630	166

**DÖNER OCAĞI  
3 RADYANLI,  
GAZLI, ÜSTTEN MOTORLU  
DONER KEBAB MACHINE  
WITH 3 RADIANTS, GAS, MOTOR ON TOP**
**INO-PDG 302**

**DÖNER OCAĞI  
4 RADYANLI,  
GAZLI, ÜSTTEN MOTORLU  
DONER KEBAB MACHINE  
WITH 4 RADIANTS, GAS, MOTOR ON TOP**
**INO-PDG 402**

**DÖNER OCAĞI  
5 RADYANLI,  
GAZLI, ÜSTTEN MOTORLU  
DONER KEBAB MACHINE  
WITH 5 RADIANTS, GAS, MOTOR ON TOP**
**INO-PDG 502**

MODEL	GENİŞ.	DER.	YÜKS.	FAYDALI ŞİŞ BOYU	ISI KAP.	DÖNER KAP.	GAZ GİR.	GAZ BASINCI	GERİLİM	N. AĞIRLIK	
	WIDTH	DEPTH	HEIGHT	SKEWER LENGTH	HEAT CAP.	MEAT CAP.	GAS INLET	GAS PRESSURE	POWER	N.WEIGHT	
	mm	mm	mm	mm	kW	Kg	Inch	LPG (G30/3)	NG (G20/25)	V	Kg
INO-PDG 302	519	726	942	460	9	20-40	1/2"	20/25 mbar	20/25 mbar	220-230V/50-60 Hz	34
INO-PDG 402	519	726	1117	635	12	40-60	1/2"	20/25 mbar	20/25 mbar	220-230V/50-60 Hz	38
INO-PDG 502	519	726	1290	800	15	60-80	1/2"	20/25 mbar	20/25 mbar	220-230V/50-60 Hz	42

# DİĞER SET ÜSTÜ PIŞİRİCİLER

.....

OTHER WORKTOP  
COOKING UNITS



**INO-PSE 100**

 SALAMANDER IZGARA  
SALAMANDER GRILL

**INO-PSE 200**

 SALAMANDER IZGARA  
SALAMANDER GRILL

MODEL	GENİŞLİK	DERİNLİK	YÜKSEKLİK	ELEKTRİK GİRİŞİ	PİŞİRME YÜZEYİ	GÜÇ	NET AĞIRLIK
	WIDTH	DEPTH	HEIGHT	ELECTRIC INLET	COOKING SURFACE	POWER	NET WEIGHT
	mm	mm	mm	V	mm	kW	Kg
INO-PSE 100	450	500	470	220-230V/50-60 Hz	V	1.7	34
INO-PSE 200	650	500	470	220-230V/50-60 Hz	640x320	3.4	52

**INO-PEK 100**

 EKMEK KIZARTMA MAKİNESİ/ KONVEYÖRLÜ  
CONVEYOR TOASTER

MODEL	GENİŞLİK	DERİNLİK	YÜKSEKLİK	ELEKTRİK GİRİŞİ	PİŞİRME YÜZEYİ	GÜÇ	NET AĞIRLIK
	WIDTH	DEPTH	HEIGHT	ELECTRIC INLET	COOKING SURFACE	POWER	NET WEIGHT
	mm	mm	mm	V	mm	kW	Kg
INO-PEK 100	465	600	440	220-230V/50-60 Hz	600	3.5	25

**INO-PFE 100**
**MİNİ FRİTÖZ  
MINI FRYER**

**INO-PFE 200**
**MİNİ FRİTÖZ  
MINI FRYER**

MODEL	PİŞİRME PERİYODU	GENİŞLİK	DERİNLİK	YÜKSEKLİK	ISI KAP.	SEPET KAP.	YAĞ KAP.	ELEKTRİK GİRİŞİ	NET AĞIRLIK
	FRYING PERIOD	WIDTH	DEPTH	HEIGHT	HEAT CAP.	BASKET CAP.	OIL CAP.	ELECTRIC INLET	NET WEIGHT
	Dakika / Min.	mm	mm	mm	kW	Kg	Lt	V	Kg
INO-PFE 100	8-12	280	400	482	3,6	1,25	5	220-230V/50-60 Hz	9
INO-PFE 200	8-12	560	400	482	3,6 + 3,6	1,25 + 1,25	5 + 5	220-230V/50-60 Hz	16



**INT-MY0002**
**BASINÇLI FRİTÖZ  
PRESSURE FRYERS**

**INT-MY0006**
**BASINÇLI FRİTÖZ  
PRESSURE FRYERS**

MODEL	GENİŞLİK	DERİNLİK	YÜKSEKLİK	TANK KAP.	YAĞ KAP.	PİŞİRME KAP.	ELEKTRİK GİRİŞİ	NET AĞIRLIK
	WIDTH	DEPTH	HEIGHT	TANK CAP.	OIL CAP.	COOKING CAP.	ELECTRIC INLET	NET WEIGHT
	mm	mm	mm	kW	Lt		V	Kg
INT-MY0002	450	560	1200	22	13	"3 kg in 13 dk. / min 14 in 1 sa / hour"	220-240V/ 6kW/50-60 Hz	9
INT-MY0006	960	960	1180	45	25	"5,5 kg in 10 dk. / min 33 in 1 sa / hour"	380V/ 15kW/50 Hz	16

**INT-TI0003**

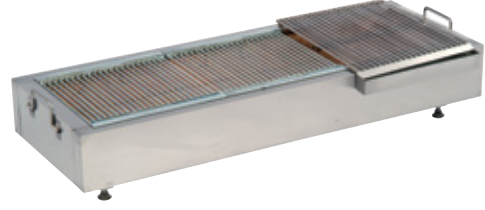
**KÖMÜRLÜ IZGARA / 100 cm**  
**NEUTRAL COAL GRILL / 100 cm**

**INT-TI0006**

**KÖMÜRLÜ IZGARA / 150 cm**  
**NEUTRAL COAL GRILL / 150 cm**

MODEL	GENİŞLİK	DERİNLİK	YÜKSEKLİK	KIZARTMA YÜZEYİ	NET AĞIRLIK
	WIDTH	DEPTH	HEIGHT	COOKING SURFACE	NET WEIGHT
	mm	mm	mm	m <sup>2</sup>	Kg
INT-TI0003	900	480	250	0.32	88
INT-TI0006	1360	480	250	0.50	116
INT-TI0009	1860	480	250	0.70	144

**INO-PIK**

**KÖMÜRLÜ IZGARA**  
**DAVLUMBAZI**  
**HOOD FOR NEUTRAL COAL GRILL**

MODEL	GENİŞLİK	DERİNLİK	YÜKSEKLİK	NET AĞIRLIK
	WIDTH	DEPTH	HEIGHT	NET WEIGHT
	mm	mm	mm	Kg
INO-PIK102	1000	650	1130	32
INO-PIK152	1500	650	1130	42
INO-PIK202	2000	650	1130	52
INO-PIK252	2500	650	1130	58
INO-PIK302	3000	650	1130	66

**INT-RE0018**
**ÇORBA ISITICISI  
SOUP WARMER**

MODEL	KAPASİTE	GÜÇ	ÖLÇÜLER	PAKET ÖLÇÜLERİ	VOLTAJ	NET AĞIRLIK
	CAPACITY	POWER	DIMENSIONS	PACKING DIMENSION	VOLTAGE	NET WEIGHT
	LT	kW	mm	mm	V	Kg
INT-RE0018	9	650W / 220V	300X330X395	365X365X420	220 V	4,5

**TOST MAKİNESİ  
ÇİFT KAPAKLI  
CONTACT GRILL / DOUBLE**
**INT-SG0066**

**TOST MAKİNESİ  
TEK KAPAKLI  
CONTACT GRILL / SINGLE**
**INT-SG0062**

**TOST MAKİNESİ  
TEK KAPAKLI  
CONTACT GRILL / SINGLE**
**INT-SG0063**

MODEL	KAPASİTE	GÜÇ	ÖLÇÜLER	NET AĞIRLIK
	CAPACITY	POWER	DIMENSIONS	NET WEIGHT
	cm	kW	cm	Kg
INT-SG0066	55x30	2+2kW, 220V	56x37x26	35
INT-SG0062	25x30	2,1kW, 220V	36x41x28	17
INT-SG0063	27x35	2,5kW, 220V	42x41x28	20
INT-SG0064	27x40	2,75kW, 220V	46x41x28	23
INT-SG0065	27x45	3kW, 220V	50x41x28	26

**INT-EP**
**DÜDÜKLÜ TENCERE  
HIGH PRESSURE POT**

AISI 304 Kalite paslanmaz çelikten üretilmiştir.

Completely made of AISI 304 18/8 stainless steel.

MODEL	AÇIKLAMA
	DETAILS
INT-EP0001	Düdüklü Tencere 40 lt. 30 kg. Pressure Pot, 40 lt, 30 kg.
INT-EP0002	Düdüklü Tencere 90 lt. 46 kg. Pressure Pot, 90 lt, 46 kg.
INT-EP0003	Düdüklü Tencere 120 lt. 60 kg. Pressure Pot, 120 lt, 60 kg.

**INT-SG0014**
**KREP MAKİNESİ / Tekli  
CREPE MACHINE / Single**

INT-SG0014	
Ebatlar Dimensions	450x500x220 mm
Ağırlık Weight	19 Kg.
Piş. Alanı Cooking Area	Ø 40 cm. 3 kw. 230 / 400 V

**INT-SG0013**
**KREP MAKİNESİ / İki  
CREPE MACHINE / Double**

INT-SG0013	
Ebatlar Dimensions	900x500x220 mm
Ağırlık Weight	37 Kg.
Piş. Alanı Cooking Area	Ø 40 cmx2/3-3 kw 230 / 400 V

**INT-SG0070**
**KREP MAKİNESİ / Tekli  
CREPE MACHINE / Single**

INT-SG0070	
Ebatlar Dimensions	600x320x300 mm
Ağırlık Weight	37 Kg.
Piş. Alanı Cooking Area	21 Cm/6 adet--2,2-2,2 Kw./230V

**INT-SG0071**
**WAFFLE MAK.  
Kalp Model / Tekli  
WAFFLE IRON  
Heart Model / Single**

INT-SG0071	
Ebatlar Dimensions	300x320x300 mm
Ağırlık Weight	19 Kg.
Piş. Alanı Cooking Area	21 Cm/3 adet--2,2 Kw/230 V

**INT-SG0072**
**WAFFLE MAK.  
Çam Model / Tekli  
WAFFLE IRON  
Pine Model / Single**

INT-SG0072	
Ebatlar Dimensions	600x320x300 mm
Ağırlık Weight	37 Kg.
Piş. Alanı Cooking Area	21 cm/6 adet--2,2-2,2 Kw/230V



**INT-SG0073**

**WAFFLE MAK.**  
Brüksel Model / Tekli  
**WAFFLE IRON**  
Brussels Model / Single

INT-SG0073	
Ebatlar Dimensions	300x320x300 mm
Ağırlık Weight	19 Kg.
Piş. Alanı Cooking Area	21 Cm/3 adet--2,2 Kw./230 V
	Çıkarılabilir model / Removable



**INT-SG0074**

**WAFFLE MAK.**  
Kornet Model / İki  
**WAFFLE IRON**  
Cornet Model / Double

INT-SG0074	
Ebatlar / Dimensions	600x320x300 mm
Ağırlık / Weight	37 Kg.
Piş. Alanı / Cooking Area	21 Cm/6 adet--2,2-2,2 Kw./230 V



**INT-SG0075**

**WAFFLE MAK.**  
Kalp Model / İki  
**WAFFLE IRON**  
Heart Model / Double

INT-SG0075	
Ebatlar / Dimensions	300x320x300 mm
Ağırlık / Weight	37 Kg.
Piş. Alanı / Cooking Area	21 Cm/3 adet--2,2 Kw./230 V



# KUZİNELER

## RANGES



- Cihazın gövdesi AISI304 kalite 18/8 Cr-Ni paslanmaz çelikten üretilmiştir.
- Şase profil konstrüksiyonludur.
- Ayarlanabilir ayakları ile 820 mm'den 860 mm'ye kadar yüksekliği ayarlanabilir.
- 1,5 modül kuzineler ayrıca paslanmaz çelik sactan yapılmış sıcaklık dolabına sahiptir.
- Pik döküm ızgaralar 120 kg yüke dayanıklıdır. Yağ akıntılarını toplayan yağ toplama tepsilerine sahiptir.
- Fırın bloğu alüminize sac olup tüm çevresi izole edilmiştir.
- Fırın iç ölçüsü 570x800x277 mm'dir.2 raflı olarak dizayn edilmiştir.
- Isıya dayanıklı cam sayesinde fırın kapağı açılmadan yiyeceklerin pişme durumu görülebilir.



- All devices and equipment are manufactured from AISI304 grade 18/8 Cr/Ni stainless steel.
- The chassis is a profile construction.
- With it's adjustable feet, the height can be adjusted from 820mm to 860mm.
- The 1,5 module ranges have exceptionally a warming board, made of stainless steel sheet.
- The gray cast iron grills can lift up to 120 kg weight.
- The oven-block is aluminized sheet and surround isolated.
- The inner dimensions of the oven-block are 570mmx800mmx270mm.
- Due to the heat-resistant glas, the cooking situation of the food can be seen without opening the door.

**INT-AP0013**
**INT-AP0017** ALT TABLALI / WITH STAND

 KUZİNE  
RANGE

**INT-AP0014**
**INT-AP0018** / ALT TABLALI / WITH STAND

 KUZİNE  
RANGE

**INT-AP0015**

 KUZİNE  
RANGE

**INT-AP0016**
**INT-AP0019** / ALT TABLALI / WITH STAND

 KUZİNE  
RANGE

MODEL	MODÜL	GENİŞLİK	DERİNLİK	YÜKSEKLİK	ISI KAPASİTESİ	GAZ GİRİŞİ	NET AĞIRLIK
	MODULE	WIDTH	DEPTH	HEIGHT	HEAT CAPACITY	GAS INLET	NET WEIGHT
		mm	mm	mm	kW	Inch	Kg
INT-AP0013	1	1000	1000	850	32,5	3/4"	140
INT-AP0014	1.5	1500	1000	850	46,5	3/4"	256
INT-AP0015	2	2000	1000	850	47	3/4"	320
INT-AP0016	2	2000	1000	850	65	3/4"	320
INT-AP0017	1 (FİRINSIZ) (WITHOUT OVEN)	1000	1000	850	28	3/4"	140
INT-AP0018	1.5 (FİRINSIZ) (WITHOUT OVEN)	1500	1000	850	42	3/4"	256
INT-AP0019	2 (FİRINSIZ) (WITHOUT OVEN)	2000	1000	850	56	3/4"	320

19811 Ürün görselleri temsilidir değişiklik gösterebilir

---

# YER OCAKLARI

.....

STOCK POT STOVE



**INO-AYR100**

 YER OCAĞI TAŞIMA ARABASI  
 STOCK POT STOVE TRANSPORT TROLLEY

**INO-1YG 200M**

 YER OCAĞI  
 STOVE

**INO-1YE 100**

 YER OCAĞI  
 STOVE

**INT-CY0001**

 YER OCAĞI, ARABALI MODEL  
 STOCK POT STOVE WITH TROLLEY

**INT-CY0004**

 YER OCAĞI, ARABALI MODEL  
 STOCK POT STOVE WITH TROLLEY

MODEL	GENİŞLİK	DERİNLİK	YÜKSEKLİK	ISI KAPASİTESİ	ELEKTRİK GİRİŞİ	GAZ GİRİŞİ
	WIDTH	DEPTH	HEIGHT	HEAT CAPACITY	ELECTRIC INLET	GAS INLET
	mm	mm	mm	kW	V	Inch
INO-1YG 200M	600	800	500	22	-	1/2"
INO-1YE 100	600	600	500	4	220-230V/50-60 Hz	-
INT-CY0001	1000	600	500	30	-	-
INT-CY0004	1250	800	500	40	-	-
INO-AYR100	820	610	605	-	-	-





**Bulaşık Yıkama  
Makineleri ve  
Ekipmanları**

Dishwashers and Equipment

# BULAŞIK YIKAMA MAKİNELERİ

DISHWASHERS



- Bulaşık yıkama makineleri, toplu yemek hizmeti verilen tüm işletmelerde veya kafeterya türü tesislerde tepsi, tabak, fincan, çatal-kaşık vb. bulaşıkları için özel olarak tasarlanmış kasetler içerisinde yıkamak için dizayn edilmiştir.
- Bulaşık yıkama makineleri ve ekipmanlarının tüm su ile temas eden bölgeleri AISI 304 KALİTE 18/8 Cr/Ni paslanmaz çelikten üretilmiştir. (S serileri hariçtir.)
- Utilization, maintenance and cleaning of dishwashers are easy, no maintenance is required other than daily cleaning and may be used safely for years, further they save elements, water, detergent and time.
- All dishwashers and equipment are manufactured from AISI304 grade 18/8 Cr/Ni stainless steel. (S series excluded.)

**BULAŞIK YIKAMA MAKİNESİ  
GLASSWASHER**

**INO-BYM 042**

INO-BYM 042

**INO-BYM 042B**

INO-BYM 042B

**INO-BYM 042S**

INO-BYM 042S

**BULAŞIK YIKAMA MAKİNESİ /  
TAHLİYE POMPALI  
GLASSWASHER / DRAIN PUMP**
**INO-BYM 042T  
INO-BYM 042ST**

INO-BYM 042T

INO-BYM 042ST

**INO-BYM 042BT**

INO-BYM 042BT



			INO-BYM 042 INO-BYM 042T	INO-BYM 042S INO-BYM 042ST	INO-BYM 042B INO-BYM 042BT
PROGRAM SAYISI PROGRAM NUMBER			3 adet / Pcs.	3 adet / Pcs.	3 adet / Pcs.
SU GİRİŞİ WATER INLET		Inch	3/4	3/4	3/4
SU GİRİŞ BASINCI WATER INLET PRESSURE		bar	2-4	2-4	2-4
SU SICAKLIĞI WATER TEMPERATURE	SU GİRİŞ WATER INLET	°C	50	50	50
	YIKAMA WASHING	°C	55	55	55
	DURULAMA RINSING	°C	85	85	85
YIKAMA POMP. MOTOR GÜCÜ WASHING PUMP ENGINE POWER		kW	0,25	0,25	0,25
ISI KAPASİTESİ HEAT CAP.	TANK / TANK	kW	1,2	1,2	1,2
	BOYLER / BOILER	kW	2,6	2,6	2,6
MAX. GÜC TÜKETİMİ MAX POWER CONSUMPTION		kW	4,15	4,15	4,15
KABLO KESİTİ CABLO CROSSECTION		mm <sup>2</sup>	3x2,5	3x2,5	3x2,5
YIKAMA + DURULAMA SÜRELERİ BYM 042/042T BYM 042S/042ST BYM 042B/042BT WASHING + RINSING TIME BYM 042/042T BYM 042S/042ST BYM 042B/042BT	90-120-180 Sn/Sec.				
	BYM 042/042ST 90 - 120 - 150 Sn /Sec.	Lt	3,2	3,2	3,2
KAPASİTE CAPACITY	KASET / RACK	Ad/ Pcs./h	40	40	40
	BARDAK / GLASS	Ad/ Pcs./h	600-800	600-800	600-800
	TANK / TANK	Lt	12	12	13
	BOYLER / BOILER	Lt	2,7	2,7	2,7
EBATLAR	GENİSLİK / WIDTH	mm	460	460	460
	DERİNLİK / DEPTH	mm	570	570	570
	YÜKSEKLİK / HEIGHT	mm	730	730	730
ELEKTRİK GİRİŞİ ELECTRIC INLET			220-230V AC / 1N / 50 Hz	220-230V AC / 1N / 50 Hz	220-230V AC / 1N / 50 Hz
NET AĞIRLIK WEIGHT		Kg	39	37	37
KONTROL PANELİ CONTROL PANEL			ELEKTRONİK ELECTRONIC	ELEKTROMEKANİK ELECTROMECHANIC	ELEKTROMEKANİK ELECTROMECHANIC
PARLATICI POMPASI RINSE AID PUMP			STANDART STANDARD	OPSİYONEL OPTIONAL	STANDART STANDARD

**INO-BYM 052**  
**INO-BYM 052T**

SET ALTI  
BULAŞIK YIKAMA  
MAKİNESİ  
UNDERCOUNTER  
DISHWASHER

**INO-BYM 052**
**INO-BYM 052T**

 TAHLİYE POMPALI  
DRAIN PUMP

**INO-BYM 052B**  
**INO-BYM 052BT**

SET ALTI  
BULAŞIK YIKAMA  
MAKİNESİ  
UNDERCOUNTER  
DISHWASHER

**INO-BYM 052B**
**INO-BYM 052BT**

 TAHLİYE POMPALI  
DRAIN PUMP

**INO-BYM 052S**  
**INO-BYM 052ST**

SET ALTI  
BULAŞIK YIKAMA  
MAKİNESİ  
UNDERCOUNTER  
DISHWASHER

**INO-BYM 052S**
**INO-BYM 052ST**

 TAHLİYE POMPALI  
DRAIN PUMP

		INO-BYM052 INO-BYM052T	INO-BYM052B INO-BYM052BT	INO-BYM052S INO-BYM052ST	INO-BYM102B-HR INO-BYM102-HR
Genişlik / Width	mm	600	600	600	
Derinlik / Depth	mm	620	630	630	
Yükseklik / Height	mm	840	825	825	
Kaset Kapasitesi / Rack Capacity	Ad/Saat pcs/h	40	25-45	40	
Tabak Kapasitesi / Plate Capacity	Ad/Saat pcs/h	540	350-630	350-630	
Bardak Kapasitesi / Glass Capacity	Ad/Saat pcs/h	1440	90-1520	900-1620	
Tepsi Kapasitesi / Tray Capacity	Ad/Saat pcs/h	360	175-315	360	
Program sayısı / Programme Number	Ad/Pcs	3	3	3	
Kısa Yıkama Periyodu / Short Washing Cycle	sn /sec	90	80	80	
Orta Yıkama Periyodu / Medium Washing Cycle	sn /sec	120	110	110	
Uzun Yıkama Periyodu / Long Washing Cycle	sn /sec	180	140	140	
Tank Kapasitesi / Tank Capacity	Lt	20	20	20	
Su Girişi / Water Inlet	Inch	3/4"	3/4"	3/4"	
Su Giriş Basıncı / Pressure of Water Supply	bar	2-4	2-4	2-4	
Su Giriş Sıcaklığı / Temperature of Water Supply	°C	50	50	50	
Su Giriş Sıcaklığı (maks.) / Temperature of Washing Water (max.)	°C	55	55	55	
Yıkama Suyu Sıcaklığı / Temperature of Washing Water	°C	55	55	55	
Durulama Suyu Sıcaklığı / Temperature of Rinse Water	°C	85	85	85	
Durulama Su Tüketimi / Rinse Water Consumption	Lt	3,2	3,2	3,2	
Yıkama Pompa Motor Gücü / Washing Pump Motor Power	kW	0,45	0,45	0,45	
Tank Isı Kapasitesi / Tank Heat Capacity	kW	2,7	2,7	2,7	
Boyer Isı Kapasitesi / Boiler Heat Capacity	kW	4,5	4,5	4,5	
Max. Güç Tüketimi / Max. Power Consumption	kW	4,95	4,95	4,95	
Elektrik Girişi / Electric Inlet	V	220-230V AC / IN / 50 Hz	220-230V AC / IN / 50 Hz	220-230V AC / IN / 50 Hz	
Durulama Pompa Motor Gücü (Opsiyonel) / Rinsing Pump Power (Optional)	kW	0,33	0,33	0,33	
Deterjan Pompası Motor Gücü (Opsiyonel) / Detergent Pump Motor Power (Optional)	W	8	8	8	
Parlatıcı Dispenser / Rinse Aid Dispenser	W	8	8	8	
Tahliye Pompası (opsiyonel) Motor Gücü / Drain Pump (Optional) Motor Power	W	30	30	30	
Net Ağırlık / Net Weight	Kg	50	48	45	

**INO-BYM 102**  
**INO-BYM 102T**

 TAHLİYE POMPALI  
 DRAIN PUMP

 GİYOTİN TİP  
 BULAŞIK YIKAMA  
 MAKİNESİ  
 HOODTYPE  
 DISHWASHER

INO-BYM 102

INO-BYM 102T

**INO-BYM 102B**  
**INO-BYM 102BT**

 TAHLİYE POMPALI  
 DRAIN PUMP

 GİYOTİN TİP  
 BULAŞIK YIKAMA  
 MAKİNESİ  
 HOODTYPE  
 DISHWASHER

INO-BYM 102B

INO-BYM 102BT

**INO-BYM 102S**  
**INO-BYM 102ST**

 TAHLİYE POMPALI  
 DRAIN PUMP

 GİYOTİN TİP  
 BULAŞIK YIKAMA  
 MAKİNESİ  
 HOODTYPE  
 DISHWASHER

INO-BYM 102S

INO-BYM 102ST

**INO-BYM102B-HR**  
**INO-BYM102-HR**

 ISI GERİ DÖNÜŞÜMLÜ  
 GİYOTİN TİP  
 BULAŞIK YIKAMA  
 MAKİNESİ  
 HEAT RECOVERY  
 HOODTYPE DISHWASHER

BYM102B-HR

BYM102-HR



			INO-BYM 102 INO-BYM 102T	INO-BYM 102S INO-BYM 102ST	INO-BYM 102B INO-BYM 102BT	INO-BYM 102B-HR INO-BYM 102-HR
Genişlik / Width		mm	740	760	760	
Derinlik / Depth		mm	743	790	790	
Yükseklik (Kapak kapalı) / Closed Door Max Height		mm	1540	1470	1470	
Yükseklik (Kapak açık) / Open Door Max Height		mm	1905	1905	1905	
Kaset Kapasitesi / Rack Capacity		Ad/Saat pcs/h	60	60	60	34
Tabak Kapasitesi / Plate Capacity		Ad/Saat pcs/h	1080	1080	1080	544
Tepsi kapasitesi / Tray Capacity		Ad/Saat pcs/h	540	540	540	272
Bardak kapasitesi / Glass Capacity		Ad/Saat pcs/h	2160	2160	2160	1224
Yıkama Periyodu / Washing Cycle		sn / sec.	60/120/180	60/120/180	60/120/180	
Ana yıkama pompası / Main Washing Pump		kW	0,6	0,6	0,6	
Isı kapasitesi / Heat Capacity	Tank / Tank	kW	2,7	2,7	2,7	
	Boiler / Boiler	kW	8	8	8	
Max. Güç Tüketimi / Max. Power Consumption		kW	8,7	11,3	8,7	8,7
Su Girişi / Water Inlet		Inch	3/4"	3/4"	3/4"	3/4"
Su Girişi Basıncı / Pressure of Water Supply		bar	2-4	2-4	2-4	2-4"
Su kapasitesi / Water Capacity	Tank / Tank	Lt	29	29	29	29
	Boiler / Boiler	Lt	6	6	6	6
Yıkama Suyu Sıcaklığı / Temperature of Washing Water		°C	55	55	55	55
Su Giriş Sıcaklığı / Temperature of Water Supply		°C	50	50	50	20-30
Su Tüketimi / Water Consumption		Lt	3,3	3,3	3,3	3,3
Durulama Suyu Sıcaklığı / Temperature of Rinse Water		°C	85	85	85	85
Elektrik Girişi / Electric Inlet		V	380-400V AC / 3N / 50 Hz	380-400V AC / 3N / 50 Hz	380-400V AC / 3N / 50 Hz	380-400V AC / 3N / 50 Hz
Kablo Kesiti / Cable Cut		mm <sup>2</sup>	5X2,5	5X4	5X4	5X4
Net Ağırlık / Net Weight		Kg	113	113	113	113

**OPSİYONLAR / OPTIONS**

Durulama Motoru / Booster Motor	W	330
Durulama Pompası / Rinsing Pump	W	8
Parlatıcı Pompası / Rinse Aid Pump	W	8
Tahliye Pompası / Drain Pump	W	30

CİHAZ TİP / TYPE	MODELLER / MODELS	PANEL / CONTROL	PARLATICI / RINSE AID	DETERJAN / DETERGENT AID	DURULAMA / RINSING PUMP	TAHLİYE / DRAIN PUMP
BARDAK YIKAMA / GLASSWASHER	INO-BYM042	DİJİTAL GÖSTERGELİ / DIGITAL	STANDART / STANDART / STANDART / STANDART	OPSİYON / OPTIONAL	OPSİYON / OPTIONAL	OPSİYON / OPTIONAL
BARDAK YIKAMA / GLASSWASHER	INO-BYM042-PZ	DİJİTAL GÖSTERGELİ / DIGITAL	OPSİYON / OPTIONAL / OPSİYON / OPTIONAL	OPSİYON / OPTIONAL	OPSİYON / OPTIONAL	OPSİYON / OPTIONAL
BARDAK YIKAMA / GLASSWASHER	INO-BYM042T	DİJİTAL GÖSTERGELİ / DIGITAL	STANDART / STANDART	OPSİYON / OPTIONAL	OPSİYON / OPTIONAL	STANDART / STANDART
BARDAK YIKAMA / GLASSWASHER	INO-BYM042TPD	DİJİTAL GÖSTERGELİ / DIGITAL	STANDART / STANDART	STANDART / STANDART	OPSİYON / OPTIONAL	STANDART / STANDART
BARDAK YIKAMA / GLASSWASHER	INO-BYM042T-PZ	DİJİTAL GÖSTERGELİ / DIGITAL	OPSİYON / OPTIONAL	OPSİYON / OPTIONAL	OPSİYON / OPTIONAL	STANDART / STANDART
BARDAK YIKAMA / GLASSWASHER	INO-BYM042B	BUTONLU / BUTTON	OPSİYON / OPTIONAL	OPSİYON / OPTIONAL	OPSİYON / OPTIONAL	OPSİYON / OPTIONAL
BARDAK YIKAMA / GLASSWASHER	INO-BYM042BT	BUTONLU / BUTTON	OPSİYON / OPTIONAL	OPSİYON / OPTIONAL	OPSİYON / OPTIONAL	STANDART / STANDART
BARDAK YIKAMA / GLASSWASHER	INO-BYM042BTPD	BUTONLU / BUTTON	STANDART / STANDART	STANDART / STANDART	OPSİYON / OPTIONAL	STANDART / STANDART
BARDAK YIKAMA / GLASSWASHER	INO-BYM042S	ŞALTERLİ / SWITCH BUTTON	OPSİYON / OPTIONAL	OPSİYON / OPTIONAL	OPSİYON / OPTIONAL	OPSİYON / OPTIONAL
BARDAK YIKAMA / GLASSWASHER	INO-BYM042ST	ŞALTERLİ / SWITCH BUTTON	OPSİYON / OPTIONAL	OPSİYON / OPTIONAL	OPSİYON / OPTIONAL	STANDART / STANDART
BARDAK YIKAMA / GLASSWASHER	INO-BYM042STPD	ŞALTERLİ / SWITCH BUTTON	STANDART / STANDART	STANDART / STANDART	OPSİYON / OPTIONAL	STANDART / STANDART
SET ALTI BULAŞIK YIKAMA / UNDERCOUNTER DISHWASHER	INO-BYM052	DİJİTAL GÖSTERGELİ	STANDART / STANDART	OPSİYON / OPTIONAL	OPSİYON / OPTIONAL	OPSİYON / OPTIONAL
SET ALTI BULAŞIK YIKAMA / UNDERCOUNTER DISHWASHER	INO-BYM052T	DİJİTAL GÖSTERGELİ	STANDART / STANDART	OPSİYON / OPTIONAL	OPSİYON / OPTIONAL	STANDART / STANDART
SET ALTI BULAŞIK YIKAMA / UNDERCOUNTER DISHWASHER	INO-BYM052T-PZ	DİJİTAL GÖSTERGELİ	OPSİYON / OPTIONAL	OPSİYON / OPTIONAL	OPSİYON / OPTIONAL	STANDART / STANDART
SET ALTI BULAŞIK YIKAMA / UNDERCOUNTER DISHWASHER	INO-BYM052-PZ	DİJİTAL GÖSTERGELİ	OPSİYON / OPTIONAL	OPSİYON / OPTIONAL	OPSİYON / OPTIONAL	OPSİYON / OPTIONAL
SET ALTI BULAŞIK YIKAMA / UNDERCOUNTER DISHWASHER	INO-BYM052N	DİJİTAL GÖSTERGELİ	STANDART / STANDART	STANDART / STANDART	OPSİYON / OPTIONAL	STANDART / STANDART
SET ALTI BULAŞIK YIKAMA / UNDERCOUNTER DISHWASHER	INO-BYM052B	BUTONLU / BUTTON	OPSİYON / OPTIONAL	OPSİYON / OPTIONAL	OPSİYON / OPTIONAL	OPSİYON / OPTIONAL
SET ALTI BULAŞIK YIKAMA / UNDERCOUNTER DISHWASHER	INO-BYM052BT	BUTONLU / BUTTON	OPSİYON / OPTIONAL	OPSİYON / OPTIONAL	OPSİYON / OPTIONAL	STANDART / STANDART
SET ALTI BULAŞIK YIKAMA / UNDERCOUNTER DISHWASHER	INO-BYM052BTPD	BUTONLU / BUTTON	STANDART / STANDART	STANDART / STANDART	OPSİYON / OPTIONAL	STANDART / STANDART
SET ALTI BULAŞIK YIKAMA / UNDERCOUNTER DISHWASHER	INO-BYM052S	ŞALTERLİ / SWITCH BUTTON	OPSİYON / OPTIONAL	OPSİYON / OPTIONAL	OPSİYON / OPTIONAL	OPSİYON / OPTIONAL
SET ALTI BULAŞIK YIKAMA / UNDERCOUNTER DISHWASHER	INO-BYM052ST	ŞALTERLİ / SWITCH BUTTON	OPSİYON / OPTIONAL	OPSİYON / OPTIONAL	OPSİYON / OPTIONAL	STANDART / STANDART
SET ALTI BULAŞIK YIKAMA / UNDERCOUNTER DISHWASHER	INO-BYM052STPD	ŞALTERLİ / SWITCH BUTTON	STANDART / STANDART	STANDART / STANDART	OPSİYON / OPTIONAL	STANDART / STANDART

CİHAZ TİPİ / TYPE	MODELLER / MODELS	PANEL / CONTROL	PARLATICI / RINSE AID	DETERJAN / DETERGENT AID	DURULAMA / RINSING PUMP	TAHLİYE / DRAIN PUMP
GİYOTİN TİPİ BULAŞIK YIKAMA / HOOD TYPE DISHWASHER	INO-BYM102	DİJİTAL GÖSTERGELİ / DIGITAL	STANDART / STANDART	OPSİYON / OPTIONAL	OPSİYON / OPTIONAL	OPSİYON / OPTIONAL
GİYOTİN TİPİ BULAŞIK YIKAMA / HOOD TYPE DISHWASHER	INO-BYM102-PZ	DİJİTAL GÖSTERGELİ / DIGITAL	OPSİYON / OPTIONAL	OPSİYON / OPTIONAL	OPSİYON / OPTIONAL	OPSİYON / OPTIONAL
GİYOTİN TİPİ BULAŞIK YIKAMA / HOOD TYPE DISHWASHER	INO-BYM102T	DİJİTAL GÖSTERGELİ / DIGITAL	STANDART / STANDART	OPSİYON / OPTIONAL	OPSİYON / OPTIONAL	STANDART / STANDART
GİYOTİN TİPİ BULAŞIK YIKAMA / HOOD TYPE DISHWASHER	INO-BYM102T-PZ	DİJİTAL GÖSTERGELİ / DIGITAL	OPSİYON / OPTIONAL	OPSİYON / OPTIONAL	OPSİYON / OPTIONAL	STANDART / STANDART
GİYOTİN TİPİ BULAŞIK YIKAMA / HOOD TYPE DISHWASHER	INO-BYM102PD	DİJİTAL GÖSTERGELİ / DIGITAL	STANDART / STANDART	STANDART / STANDART	OPSİYON / OPTIONAL	OPSİYON / OPTIONAL
GİYOTİN TİPİ BULAŞIK YIKAMA / HOOD TYPE DISHWASHER	INO-BYM102N	DİJİTAL GÖSTERGELİ / DIGITAL	STANDART / STANDART	STANDART / STANDART	OPSİYON / OPTIONAL	STANDART / STANDART
GİYOTİN TİPİ BULAŞIK YIKAMA / HOOD TYPE DISHWASHER	INO-BYM102B	BUTONLU / BUTTON	OPSİYON / OPTIONAL	OPSİYON / OPTIONAL	OPSİYON / OPTIONAL	OPSİYON / OPTIONAL
GİYOTİN TİPİ BULAŞIK YIKAMA / HOOD TYPE DISHWASHER	INO-BYM102BPD	BUTONLU / BUTTON	STANDART / STANDART	STANDART / STANDART	OPSİYON / OPTIONAL	OPSİYON / OPTIONAL
GİYOTİN TİPİ BULAŞIK YIKAMA / HOOD TYPE DISHWASHER	INO-BYM102BT	BUTONLU / BUTTON	OPSİYON / OPTIONAL	OPSİYON / OPTIONAL	OPSİYON / OPTIONAL	STANDART / STANDART
GİYOTİN TİPİ BULAŞIK YIKAMA / HOOD TYPE DISHWASHER	INO-BYM102S	ŞALTERLİ / SWITCH BUTTON	OPSİYON / OPTIONAL	OPSİYON / OPTIONAL	OPSİYON / OPTIONAL	OPSİYON / OPTIONAL
GİYOTİN TİPİ BULAŞIK YIKAMA / HOOD TYPE DISHWASHER	INO-BYM102ST	ŞALTERLİ / SWITCH BUTTON	OPSİYON / OPTIONAL	OPSİYON / OPTIONAL	OPSİYON / OPTIONAL	STANDART / STANDART
GİYOTİN TİPİ BULAŞIK YIKAMA / HOOD TYPE DISHWASHER	INO-BYM102SPD	ŞALTERLİ / SWITCH BUTTON	STANDART / STANDART	STANDART / STANDART	OPSİYON / OPTIONAL	OPSİYON / OPTIONAL
ISI GERİ DÖNÜŞÜM SİSTEMLİ GİYOTİN TİPİ BULAŞIK YIKAMA / HOOD TYPE DISHWASHER WITH HEAT RECOVERY SYSTEM	INO-BYM102-HR	DİJİTAL GÖSTERGELİ / DIGITAL	STANDART / STANDART	STANDART / STANDART	STANDART / STANDART	OPSİYON / OPTIONAL
ISI GERİ DÖNÜŞÜM SİSTEMLİ GİYOTİN TİPİ BULAŞIK YIKAMA / HOOD TYPE DISHWASHER WITH HEAT RECOVERY SYSTEM	INO-BYM102T-HR	DİJİTAL GÖSTERGELİ / DIGITAL	STANDART / STANDART	STANDART / STANDART	STANDART / STANDART	STANDART / STANDART
ISI GERİ DÖNÜŞÜM SİSTEMLİ GİYOTİN TİPİ BULAŞIK YIKAMA / HOOD TYPE DISHWASHER WITH HEAT RECOVERY SYSTEM	INO-BYM102B-HR	BUTONLU / BUTTON	OPSİYON / OPTIONAL	OPSİYON / OPTIONAL	STANDART / STANDART	OPSİYON / OPTIONAL
ISI GERİ DÖNÜŞÜM SİSTEMLİ GİYOTİN TİPİ BULAŞIK YIKAMA / HOOD TYPE DISHWASHER WITH HEAT RECOVERY SYSTEM	INO-BYM102BT-HR	BUTONLU / BUTTON	OPSİYON / OPTIONAL	OPSİYON / OPTIONAL	STANDART / STANDART	STANDART / STANDART

TÜRKİYE'DE  
İLK VE TEK

# Isı Geri Kazanımlı İnoksan Bulaşık Makinesi ile mutfak standartlarınız değişiyor!

YENİ



Üst Düzey  
Hijyen



Yüksek  
Verim



Mutfağınızda  
Alan Tasarrufu



Daha  
Az Enerji



%20 ENERJİ  
TASARRUFU

**İNOKSAN**

INO-BYM102B-HR

MODEL	OPSİYONEL / OPTIONAL
2021208110	Durulama Pompası (BYM052) / Rinsing Pump
2021208210	Durulama Pompası (BYM052S) / Rinsing Pump
2021008100	Durulama Pompası (BYM102) / Rinsing Pump
2021408011	Durulama Pompası (BYM042) / Rinsing Pump
2021208120	Tahliye Pompası (BYM052) / Drain Pump
2021008101	Tahliye Pompası (BYM102) / Drain Pump
2021408020	Tahliye Pompası (BYM042) / Drain Pump
2021208200	Tahliye Pompası (BYM052S) / Drain Pump
2021208100	Parlatıcı Pompası (BYM052) / Rinsing Pump
2021008111	Parlatıcı Pompası (BYM102) / Rinsing Pump
2021208130	Deterjan Pompası (BYM052) / Detergent Pump
2021408010	Deterjan Pompası (BYM042) / Detergent Pump
2021008121	Deterjan pompası (BYM102S) / Detergent Pump
2021008130	Durulama pompası (BYM102S) / Rinsing Pump
2021008131	Boşaltma pompası (BYM102S) Drain Pump
2021408000	Parlatıcı pompası (BYM042) / Rinsing Pump
2021408021	Boşaltma pompası (BYM042S) / Drain Pump
2021408030	Durulama pompası (BYM042S) / Rinsing Pump
2021408031	Parlatıcı pompası (BYM102S) / Rinsing Pump
2021408040	Parlatıcı pompası (BYM042S) / Rinsing Pump
2021408041	Deterjan pompası (BYM042S) / Detergent Pump
2021318000	Deterjan ve parlatıcı pompası (BYK/BYF/BKE) / Detergent and Rinse aid Pump

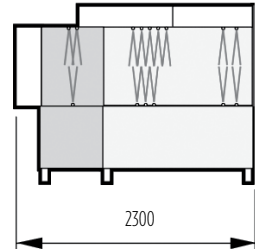
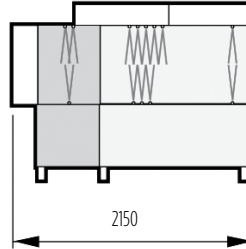
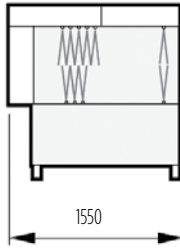
**INO-BYK**
**KONVEYÖRLÜ BULAŞIK YIKAMA MAKİNELERİ  
CONVEYOR TYPE DISHWASHERS**

**INO-BYK 220L/R**

Kapasite: 1600-2200 tabak/saat  
Capacity: 1600-2200 plate / h

Konveyörlü, ön yıkamasız  
With Conveyor, (Without Prewash)

Genişlik: 1800 mm (Kurutmasız)  
Width: 1800 mm (Without Drying)

Genişlik: 2250 mm (K70 kurutmalı)  
Width: 2250 mm (K70 Dryer)

Genişlik: 2450 mm (K90 kurutmalı)  
Width: (K90 Dryer)

Genişlik: 2420 mm -2450mm  
(K70D LR Köşe Kurutma)  
Width: 2420 mm - 2450mm (K70D LR Dryer)

**INO-BYK 270L/R**

Kapasite: 2200-2700 tabak/saat  
Capacity 2200-2700 plate / h

Konveyörlü, ön yıkamalı  
With Conveyor Prewash

Genişlik: 2400 mm (Kurutmasız)  
Width: 2400 mm (Without Drying)

Genişlik: 2850 mm (K70 kurutmalı)  
Width : 2850 mm (K70 Dryer)

Genişlik: 3050 mm (K90 kurutmalı)  
Width : 3050 mm (K90 Dryer)

Genişlik: 3020 mm (K70D LR Köşe Kurutma)  
Width : 3020 mm (K70D LR Dryer)

**INO-BYK 360L/R**

Kapasite: 2800-3600 tabak/saat  
Capacity 2800-3600 plate / h

Konveyörlü, ön yıkamalı, çift durulamalı  
With Conveyor Prewash Double Rinse

Genişlik: 2550 mm (Kurutmasız)  
Width: 2550 mm (Without Drying)

Genişlik: 3000 mm (K70 kurutmalı)  
Width : 3000 mm (K70 Dryer)

Genişlik: 3200 mm (K90 kurutmalı)  
Width : 3200 mm (K90 Dryer)

Genişlik: 3170 mm (K70D LR kurutmalı)  
Width : 3170 mm (K70D LR Dryer)

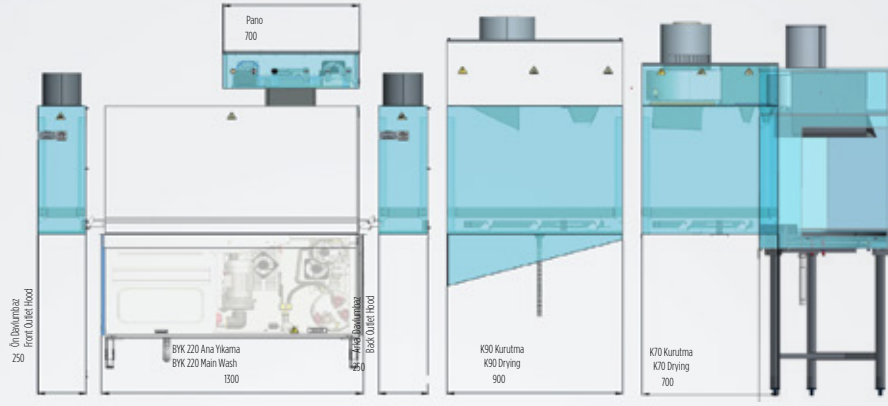

MODEL	ÖN DAVLUMBAZ	ANA YIKAMA	ÖN YIKAMA	ÇİFT DURULAMA	ARKA DAVLUMBAZ	K90 KURUTMA	K70D KÖŞE KURUTMA	K70D KÖŞE KURUTMA	ISI GERİ DÖNÜŞÜM
	FRONT OUTLET HOOD	MAIN WASH	PRE WASH	DOUBLE RINSE	BACK OUTLET HOOD	K90 DRYING	K70D CORNER DRYING 880	K70D CORNER DRYING	HEAT TRANSFORMATION
INO-BYK 220	✓	✓	-	-	Opsiyonel Optional	Opsiyonel Optional	Opsiyonel Optional	Opsiyonel Optional	-

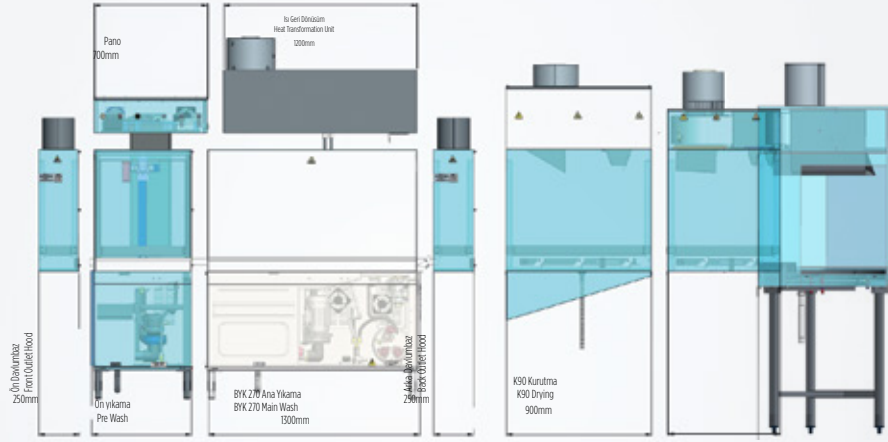

MODEL	ÖN DAVLUMBAZ	ANA YIKAMA	ÖN YIKAMA	ÇİFT DURULAMA	ARKA DAVLUMBAZ	K70 KURUTMA	K70D KÖŞE KURUTMA	K70D KÖŞE KURUTMA	ISI GERİ DÖNÜŞÜM
	FRONT OUTLET HOOD	MAIN WASH	PRE WASH	DOUBLE RINSE	BACK OUTLET HOOD	K70 DRYING 700	K70D CORNER DRYING 880	K70D CORNER DRYING	HEAT TRANSFORMATION
INO-BYK 270	✓	✓	✓	-	Opsiyonel Optional	Opsiyonel Optional	Opsiyonel Optional	Opsiyonel Optional	Opsiyonel Optional

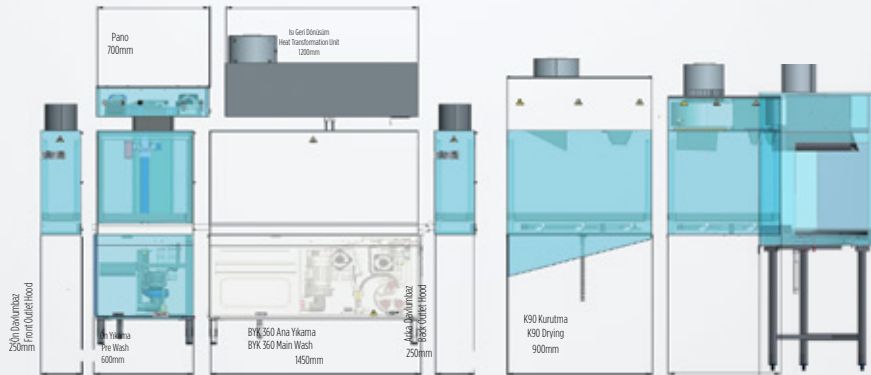

KOD	ÖN DAVLUMBAZ	ANA YIKAMA	ÖN YIKAMA	ÇİFT DURULAMA	ARKA DAVLUMBAZ	K70 KURUTMA	K70D KÖŞE KURUTMA	K70D KÖŞE KURUTMA	ISI GERİ DÖNÜŞÜM
	FRONT OUTLET HOOD	MAIN WASH	PRE WASH	DOUBLE RINSE	BACK OUTLET HOOD	K70 DRYING 700	K70D CORNER DRYING 880	K70D CORNER DRYING	HEAT TRANSFORMATION
INO-BYK 360	✓	✓	✓	✓	Opsiyonel Optional	Opsiyonel Optional	Opsiyonel Optional	Opsiyonel Optional	Opsiyonel Optional

MODEL		INO-BYK 220L-R	INO-BYK 270L-R	INO-BYK 360L-R
Genişlik (K70 - K70D kurutmalı) / Width (with K70 drying )	mm	2250-2420	2850-3020	3000-3170
Genişlik (K90 kurutmalı) / Width (with K90 drying )	mm	2450	3050	3200
Derinlik / Depth	mm	800	800	800
Yükseklik / Height	mm	1750	1750	1750
Yükseklik (K70 - K70D kurutmalı) / Height (with K70 drying )	mm	2020	2020	2020
Yükseklik (K90 kurutmalı) / Height (with K90 drying )	mm	2050	2050	2050
Kaset Kapasitesi / Rack cap.	Ad. / Pcs	90-120	120-150	160-200
Tabak Kapasitesi / Plate cap.	Ad. / Pcs	1620-2160	2160-2700	2880-3600
Ana yıkama pompası / Main wash pump	kW	1.5	1.5	1.5
Ön yıkama pompa motor gücü / Prewashing pump motor power	kW	-	0.6	0.6
Konveyör redüktörlü motor gücü / Conveyor reducer motor power	kW	0,55	0,55	0,55
Kurutma Pompa Motor Gücü (K70 - K70D) / Drying pump motor power (K70)	kW	0,55	0,55	0,55
Kurutma Pompa Motor Gücü(K90) / Drying pump motor power (K90)	kW	1,1	1,1	1,1
Çift durulama motor gücü / Double rinsing motor power	kW	-	-	0.2
Ana yıkama ısı kapasitesi / Main wash heat cap.	kW	8	8	8
Kurutma(K70 - K70D) ısı kapasitesi / Drying heat cap. (K70)	kW	6	6	6
Kurutma(K90) ısı kapasitesi / Drying heat cap. (K90)	kW	12	12	12
Boiler ısı kapasitesi / Boiler heat cap.	kW	24	24	24
Su Girişi / Water inlet	Inch	3/4"	3/4"	3/4"
Su Giriş Basıncı / Water inlet pressure	bar	2-4	2-4	2-4
Ana yıkama Tank Kapasitesi / Main wash tank cap.	Lt	125	125	125
Ön yıkama Tank Kapasitesi / Pre-wash tank cap.	Lt	x	54	54
Ön Yıkama Suyu Sıcaklığı / Washing Prewash temperature	°C	x	45	45
Yıkama Suyu Sıcaklığı / Washing water temperature	°C	55	55	55
Su Giriş Sıcaklığı / Water intake temperature	°C	40-45	40-45	40-45
Durulama Suyu Sıcaklığı / Rinsing water temperature	°C	85	85	85
Max. Güç Tüketimi / Max. Power consumption	Kw	33.65+0.55	34.25+0.55	34.5+0.55
Elektrik Girişi / Electric Intake	V/Hz	380-400V AC / 3N / 50 Hz	380-400V AC / 3N / 50 Hz	380-400V AC / 3N / 50 Hz
Kablo Kesiti / Cable Cut	mm <sup>2</sup>	4x16	4x16	4x16

**TOPLAM GÜÇLER / TOTAL POWER**

MODEL		INO-BYK 220L-R	INO-BYK 270L-R	INO-BYK 360L-R
Kurutmasız / Without drying unit	kW	34	34,6	34,8
K70 - K70 D kurutmalı / With K70- K70 D	kW	41	41,6	41,8
K90 kurutmalı / With K90	kW	47	47,6	47,8
Isı geri dönüşümlü K70 - K70D / Heat Transformation K70 K70D	kW	-	41,8	42
Isı geri dönüşümlü K90 / Heat Transformation K90	kW	-	47,8	48

**2021310500**
**K70D KÖŞE KURUTMA ÜNİTESİ  
K70D CORNER TYPE DRYING UNIT**

MODEL	AÇIKLAMA / FEATURES
2021310850	Köşe Kurutma, sol dönüşlü / Drying Unit Left Corner type, Drying Unit Left Uzunluk: 87 cm / Length 87
2021310851	Köşe Kurutma, sağ dönüşlü / Drying Unit Right Corner type, Drying Unit Right Uzunluk: 87 cm / Length 87

MODEL	OPSİYONEL / OPTIONAL
2021310500	Kurutma Ünitesi 70 cm / Drying Unit 70 cm
2021310391	Kurutma Ünitesi 90 cm / Drying Unit 90 cm
2021310581	Çıkış Davlumbazı / Outlet Hood

Ürün eğer kurutmasız olacaksa 250mm uzunluğunda INO-BYK-CD model çıkış davlumbazı siparişe ilave edilmelidir.İsı geridönüşüm üniteleri INO-BYK270 ve INO-BYK360 modellerine uygulanabilir.  
If machine without drying unit, BYK CD outlet hood lenght 250mm has to be ordered. Heat transformation units available for BYK270/360 models.

**INO-BKE2000 / R**
**KONVEYÖRLÜ BULAŞIK YIKAMA MAKİNESİ  
CONVEYOR TYPE DISHWASHER**
**INO-BKE2000 / R**

Kapasite: 2000 tabak/saat / Capacity: 2000 pl/hr

Ön Yıkama+Yıkama+Durulama+Kurutma / Prewash+Wash+Rinse+Dry

**ÜRÜN BİLGİLERİ / FEATURES**

		INO-BKE2000/R
Genişlik / Width	mm	2955
Yükseklik / Height	mm	1365
Yükseklik (Kapak açık) / Open Door Max. Height	mm	1905
Derinlik / Depth	mm	795
Tabak Kapasitesi / Plate cap.	Ad./Sa Pcs./h	2000
Kaset Kapasitesi / Rack Capacity	Ad./Sa Pcs./h	125
Bardak Kapasitesi / Glass Capacity	Ad./Sa Pcs./h	3125
Tepsi Kapasitesi / Tray Capacity	Ad./Sa Pcs./h	1000
Yıkama Isı Kapasitesi / Washing heat cap.	kW	6
Boyle Isı Kapasitesi / Boiler heat cap.	kW	16
Kurutma Isı Kapasitesi / Drying heat cap.	kW	6
Ön Yıkama Pompa Motor Gücü / Pre-wash Pump Motor Power	kW	0,6
Konveyör Redüktör Motor Gücü / Conveyor reducer motor power	kW	0,25
Yıkama Pompa Motor Gücü / Washing Pump Motor Power	kW	1,5
Kurutma Fan Motor Gücü / Drying Pump Motor Power	kW	0,55
Maksimum Güç Tüketimi / Max. Power consumption	kW	31,3
Yıkama Tankı su Kapasitesi / Wash water tank cap.	Lt	110
Ön Yıkama Tankı Su Kapasitesi / Pre-Wash tank water cap.	Lt	80
Su Girişi / Water Inlet	Inch	3/4
Kaset Geçiş Süresi / Basket Cycle Period	sn/sec	228
Su Giriş Basıncı / Pressure of Water Supply	Bar	2-4
Su Giriş Sıcaklığı / Temperature of Water Supply	°C	50
Yıkama Suyu Sıcaklığı / Washing water temperature	°C	50
Durulama Suyu Sıcaklığı / Rinsing water temperature	°C	85
Elektrik Girişi / Electric Inlet	V	380-400V AC / 3N / 50 Hz
Net Ağırlık / Net Weight	Kg	415



CE PG EHC  
**FLIGHT TİP BULAŞIK MAKİNESİ**  
**FLIGHT TYPE DISHWASHER**

## INO-BYF

### INO-BYF 520L / R

Kapasite: 5200 tabak/saat  
 Capacity: 5200 pl/hr

Ön Yıkama+Çift Yıkama+Çift Durulama  
 Prewash + Double Wash + Double Rinse

### INO-BYF 600L / R

Kapasite: 6000 tabak/saat  
 Capacity: 6000 pl/hr

Güçlü Ön Yıkama+Çift Yıkama+Çift Durulama  
 Heavy Prewash + Double Wash + Double Rinse

### INO-BYF 300L / R

Kapasite: 3000 tabak/saat  
 Capacity: 3000 pl/hr

Yıkama+Çift Durulama  
 Washing + Double Rinsing

### INO-BYF 360L / R

Kapasite: 3600 tabak/saat  
 Capacity: 3000 pl/hr

Ön Yıkama+Yıkama+Çift Durulama  
 Prewash+Wash+Double Rinse

### INO-BYF 450L / R

Kapasite: 4500 tabak/saat  
 Capacity: 4500 pl/hr

Güçlü Ön Yıkama+Yıkama+Çift Durulama  
 Heavy Prewash + Double Wash + Double Rinse

## OPSİYONLAR / OPTIONS

(BYF makineleri dahil değildir. Seçilmelidir.)  
 (Not included to standard machines)

KOD	AÇIKLAMA / FEATURES
INO-BYF-K17	Normal Kurutma, 1700mm çıkış ünitesi Normal dryer, 1700mm outlet unit
INO-BYF-K20	Normal Kurutma, 2000mm çıkış ünitesi Normal dryer, 2000mm outlet unit
INO-BYF-KP20	Heavy dryer, 2000mm outlet unit
INO-BYF-KP25	Kuvvetli Kurutma, 2500mm çıkış ünitesi Heavy dryer, 2500mm outlet unit

### 2021300850

Isı Geri Kazanım Ünitesi  
 Heat Recovery Unit



**MAKARALI ÖN YIKAMA DUŞU**  
**WASHING HOSE REEL**

## INT-CC

KOD	ÖLÇÜLER / DIMENSIONS
INT-CC0010	6 m
INT-CC0011	10 m
INT-CC0012	15 m

Bulaşık Yıkama Makineleri 40-45 °C sıcak su girişine göre üretilmektedir. 40-45°C'nin altındaki su girişlerinde ısı geri kazanım ünitesi önerilmektedir.  
 Dishwashing machines are produced according to 40-45°C water. Under 40-45°C water inlet, heat recovery unit should be recommended.



VIEW MODEL	VIEW MODEL	"BYF-K17 (Normal Drying, 1700 mm outlet)"	"BYF-K20 (Normal Drying, 2000 mm outlet)"	"BYF-KP20 (Strong Drying, 2000 mm outlet)"	"BYF-KP25 (Strong Drying, 2500 mm outlet)"	Heat Transformation
<p><b>BYF300L / BYF300R</b></p> <p><b>WASH + RINSE</b> (WITHOUT PRE-WASH)</p>	<p>X</p>					X
<p><b>BYF360L / BYF360R</b></p> <p><b>PRE-WASH</b> + <b>WASH + RINSE</b></p>	<p><b>BYF450L / BYF450R</b></p> <p><b>STRONG PRE-WASH</b> + <b>WASH + RINSE</b></p>					
<p><b>BYF520L / BYF520R</b></p> <p><b>PREWASH</b> + <b>DOUBLE WASH + RINSE</b></p>	<p><b>BYF600L / BYF600R</b></p> <p><b>STRONG PRE-WASH</b> + <b>DOUBLE WASH + RINSE</b></p>	XXXX				

**ANA ÜRÜNLER / MAIN PRODUCTS**

MODEL		INO-BYF300L/R	INO-BYF360L/R	INO-BYF450L/R	INO-BYF520L/R	INO-BYF600L/R
Genişlik / Width	mm	2750	3350	3700	4300	4650
Yükseklik / Height	mm	1760	1760	1760	1760	1760
Yükseklik (Isı geri dönüşümlü) Height with heat transformation unit	mm	X	2200	2200	2200	2200
Yükseklik (kapak açıldığında) / Open Door Max Height	mm	2170	2170	2170	2170	2170
Derinlik / Depth	mm	880	880	880	880	880
Tabak Kapasitesi / Plate cap.	Ad./Sa Pcs./h	3000	3600	4500	5200	6000
Ana yıkama pompa gücü / Main wash pump power	kW	3	3	3	3	3
Ön yıkama pompa gücü / Prewashing pump power	kW	X	1,5	1,5	1,5	1,5
Konveyör redüktörlü motor gücü Conveyor reducer motor power	kW (50Hz)	0,37	0,37	0,37	0,37	0,37
Konveyör redüktörlü motor gücü Conveyor reducer motor power	kW (60Hz)	0,45	0,45	0,45	0,45	0,45
Çift durulama motor gücü Double rinsing motor power	kW	0,19	0,19	0,19	0,19	0,19
Yıkama Isı kapasitesi / Washing heat cap.	kW	12	12	12	12	12
Boiler ısı Kapasitesi / Boiler heat cap.	kW	32	32	32	32	32
Su Giriş Basıncı / Water inlet pressure	bar	2-4	2-4	2-4	2-4	2-4
Yıkama Tankı Su Kapasitesi / Wash water tank cap.	Lt	125	125	125	125	125
Ön Yıkama Tankı Su Kapasitesi/ Pre-wash tank cap.	Lt	X	60	60	60	60
Boiler Su Kapasitesi / Boiler water capacity	Lt	36	36	36	36	36
Su Giriş Sıcaklığı / Water intake temperature	°C	40-45	40-45	40-45	40-45	40-45
Yıkama Suyu Sıcaklığı / Washing water temperature	°C	55	55	55	55	55
Ön Yıkama Suyu sıcaklığı Washing Prewash temperature	°C	X	45	45	45	45
Durulama Suyu Sıcaklığı/ Rinsing water temperature	°C	85	85	85	85	85
Durulama Su Sarfıyatı / Rinsing Water Consumption	Lt/sa / h	400-450	400-450	400-450	400-450	400-450
Max. Güç Tüketimi/ Max. Power consumption	kW	39,5	41	42,5	54,5	56
Elektrik Girişi / Electric Intake	V/Hz	380-400V AC/3N /50Hz	380-400V AC/3N /50Hz	380-400V AC/3N /50Hz	380-400V AC/3N /50Hz	380-400V AC/3N /50Hz

MODEL		INO-BYF-K17 (Normal Kurutmalı) (With Normal Drying)	INO-BYF-K20 (Normal Kurutmalı) (With Normal Drying)	INO-BYF-KP20 (Kuvvetli Kurutmalı) Heavy Drying	INO-BYF-KP25 (Kuvvetli Kurutmalı) Heavy Drying
Genişlik / Width	mm	1700	2000	2000	2500
Yükseklik / Height	mm	2020	2020	2020	2020
Normal Kurutma Uzunluğu/ Normal Drying Length	mm	950	950	X	X
Kuvvetli Kurutma Uzunluğu / Heavy Drying Length	mm	X	X	1030	1030
Derinlik / Depth	mm	940	940	940	940
Normal Kurutma Pompa Motor Gücü Normal Drying Pump Motor Power	kW	1,1	1,1	X	X
Kuvvetli Kurutma Pompa Motor Gücü Heavy drying pump motor power	kW	X	X	1,5	1,5
Normal Kurutma Isı kapasitesi Normal Drying Heat Capacity	kW	12	12	X	X
Kuvvetli Kurutma Isı kapasitesi / Heavy drying heat capacity	kW	X	X	18	18
Toplam Maksimum Güç Tüketimi Total Max. Power consumption	kW	13,7	13,7	20,1	20,1



# BULAŞIKHANE EKİPMANLARI

EQUIPMENT FOR DISHWASHERS



- Tamamı AISI304 kalite 18/8 Cr-Ni paslanmaz çelikten üretilmiştir.
- Ayaklar ve taşıyıcı konstrüksiyonda paslanmaz çelik profil kullanılmıştır.
- Hijyenik, kolay temizlenebilir ve montaj gerektirmeyen pratik kullanıma sahiptir.
- Fonksiyonel tasarımı ile depolama ve kullanım kolaylığı sağlar.
- Tezgah yüksekliği 82 cm ile 87 cm arasında ayarlanabilir.

- All devices and equipment are manufactured from AISI304 grade 18/8 Cr/Ni stainless steel.
- Stainless steel profile is used in feet and support construction.
- Hygienic, easy to clean and does not require assembly for convenient usage.
- Ease of use and storage with functional design.
- Height of tables can be adjusted between 82 cm and 87 cm.



**BULAŞIK SIYIRMA TEZGAHI**  
SOILED DISH SORTING TABLE WITH SCRAPPING HOLE



KOD	ÖLÇÜLER
	DIMENSIONS
INO-BSN 100	1000X725X850
INO-BSN 120	1200X725X850
INO-BSN 140	1400X725X850
INO-BSN 160	1600X725X850
INO-BSN 180	1800X725X850
INO-BSN 200	2000X725X850
INO-BSN 220	2200X725X850
INO-BSN 240	2400X725X850



**BULAŞIK ALMA TEZGAHI**  
SOILED DISH SORTING TABLE WITH SCRAPPING HOLE



KOD	ÖLÇÜLER
	DIMENSIONS
INO-BAT 140	1400X1100X850
INO-BAT 160	1600X1100X850
INO-BAT 180	1800X1100X850
INO-BAT 200	2000X1100X850
INO-BAT 220	2200X1100X850
INO-BAT 240	2400X1100X850
INO-BAT 260	2600X1100X850
INO-BAT 280	2800X1100X850

KOD	ÖLÇÜLER
	DIMENSIONS
INO-BRD 110	1100X500X500
INO-BRD 160	1600X500X500

\* Duvar monte  
\* Wall Mounted

"Kaset rafı fiyatı dahil değildir."  
\*Rack shelf not included price.



**KASET RAFI  
RACK SHELF**

KOD	ÖLÇÜLER
	DIMENSIONS
INO-BRT 120	1200X600X600
INO-BRT 140	1400X600X600
INO-BRT 160	1600X600X600
INO-BRT 180	1800X600X600
INO-BRT 200	2000X600X600
INO-BRT 220	2200X600X600
INO-BRT 240	2400X600X600
INO-BRT 260	2600X600X600
INO-BRT 280	2800X600X600

\*Tezgaha monte  
\*Table Mounted



**MAKİNE GİRİŞ EVİYESİ / TEK KÜVETLİ  
DISHWASHER INLET TABLE / SINGLE SINK**

KOD	KOD	ÖLÇÜLER
	MODEL	DIMENSIONS
INO-BEN 080L	INO-BEN 080R	800X725X850
INO-BEN 100L	INO-BEN 100R	1000X725X850
INO-BEN 120L	INO-BEN 120R	1200X725X850
INO-BEN 140L	INO-BEN 140R	1400X725X850



"1000 Tıh/INO-BYMlere ve INO-BYK modellere uygundur."

\*Available for BYM and BYK models.



**MAKİNE GİRİŞ EVİYESİ / TEK KÜVETLİ / PERFORE ALT TABLALI**  
**DISHWASHER INLET TABLE / SINGLE SINK / PERFORATED LOWER SHELF**



**MAKİNE GİRİŞ EVİYESİ / ÇİFT KÜVETLİ**  
**DISHWASHER INLET TABLE / DOUBLE SINK**



**MAKİNE GİRİŞ EVİYESİ / ÇİFT KÜVETLİ / PERFORE ALT TABLALI**  
**DISHWASHER INLET TABLE / DOUBLE SINK / PERFORATED LOWER SHELF**



**MAKİNE GİRİŞ EVİYESİ / TEK KÜVETLİ / SIYIRMA HUNİLİ**  
**DISHWASHER INLET TABLE / SINGLE SINK / SCRAPPING HOLE**



KOD	KOD	ÖLÇÜLER
	KOD	DIMENSIONS
INO-BER 100L	INO-BER 100R	1000X725X850
INO-BER 120L	INO-BER 120R	1200X725X850
INO-BER 140L	INO-BER 140R	1400X725X850

"1000 Tb/H/INO-BYMlere ve INO-BYK modellere uygundur."

\*Available for BYM and BYK models.

KOD	KOD	ÖLÇÜLER
	KOD	DIMENSIONS
INO-B2N 140L	INO-B2N 140R	1400X725X850
INO-B2N 160L	INO-B2N 160R	1600X725X850
INO-B2N 180L	INO-B2N 180R	1800X725X850

"1000 Tb/H/INO-BYMlere ve INO-BYK modellere uygundur."

\*Available for BYM and BYK models.

KOD	KOD	ÖLÇÜLER
	KOD	DIMENSIONS
INO-B2R 140L	INO-B2R 140R	1400X725X850
INO-B2R 160L	INO-B2R 160R	1600X725X850
INO-B2R 180L	INO-B2R 180R	1800X725X850

"1000 Tb/H/INO-BYMlere ve INO-BYK modellere uygundur."

\*Available for BYM and BYK models.

KOD	KOD	ÖLÇÜLER
	KOD	DIMENSIONS
INO-BEN 160SL	INO-BEN 160SR	1600X725X850

"1000 Tb/H/INO-BYMlere ve INO-BYK modellere uygundur."

\*Available for BYM and BYK models.



**BARDAK BULAŞIK EVİYELERİ  
GLASS SINK TABLE**

KOD	ÖLÇÜLER
	DIMENSIONS
INO-BEB120 R/L	1200X600X850
INO-BEB 140 R/L	1400X700X850



**MAKİNE ÇIKIŞ TEZGAHI / 180° dönüştü  
DISHWASHER OUTLET TABLE / Conveyor / 180°**



**MAKİNE ÇIKIŞ TEZGAHI / 90° dönüştü  
DISHWASHER OUTLET TABLE / Conveyor / 90°**



KOD	ÖLÇÜLER / DIMENSIONS
INO-BCK180 R/L	1400X805X890



KOD	ÖLÇÜLER / DIMENSIONS
INO-BCK090R/L	850X850X850



**MAKİNE GİRİŞ TEZGAHI / 90° dönüştü  
DISHWASHER INLET TABLE / Conveyor / 90°**



KOD	ÖLÇÜLER / DIMENSIONS
INO-BGK090 R/L	850X850X850

Yıkama makinesi "sol" seçildi ise köşe tezgahı da "sol" seçilmeli.  
Örneğin makine INO-BYK270L ise köşe tezgahı da INO-BCK090L yada BCK180L olmalı.  
Conveyor corner table must be chosen with the same direction of dishwasher.



**MAKİNE GİRİŞ - ÇIKIŞ TEZGAHI**  
**DISHWASHER INLET - OUTLET TABLE**

KOD	ÖLÇÜLER
	DIMENSIONS
INO-BTN060L	600X580X850
INO-BTN080L	800X580X850
INO-BTN100L	1000X580X850
INO-BTN120L	1200X580X850
INO-BTN140L	1400X580X850
INO-BTN161R	1600X580X850

"1000 Tb/H INO-BYM'lere ve INO-BYK modellere uygundur."

\*Available for BYM and BYK models.



**MAKİNE GİRİŞ- ÇIKIŞ TEZGAHI / PERFORE ALT TABLALI**  
**DISHWASHER INLET-OUTLET TABLE / PERFORATED LOWER SHELF**

KOD	ÖLÇÜLER / DIMENSIONS
INO-BTR060L	600X580X850
INO-BTR080L	800X580X850
INO-BTR100L	1000X580X850
INO-BTR120L	1200X580X850
INO-BTR140L	1400X580X850



**MAKİNE BİTİŞ TEZGAHI / KONVEYÖRLÜ**  
**DISHWASHER INLET- OUTLET TABLE / CONVEYOR**

KOD	KOD	ÖLÇÜLER / DIMENSIONS
INO-BCB 100L	INO-BCB 100R	1000X535X850
INO-BCB 120L	INO-BCB 120R	1200X535X850
INO-BCB 140L	INO-BCB 140R	1400X535X850
INO-BCB 160L	INO-BCB 160R	1600X535X850



Stop swiçi bulaşık makinesiyle birlikte verilmektedir.  
Stop switch shown on above photo is a part of dishwasher.

"1000 Tb/H INO-BYM'lere ve INO-BYK modellere uygundur."  
Available for all BYM and BYK models.



**BULAŞIK MAKİNE STANDI**  
**STAND FOR DISHWASHER**

KOD	ÖLÇÜLER / DIMENSIONS
INO-BTS 060	600X600X450





**INT-CC0017**

ÖN YIK.  
SPREY ÜNİTESİ  
PRE-RINSE FAUCET

Tezgaha Monte Klasik  
Table Mounted



**INT-CC0018**

ÖN YIK.  
SPREY ÜNİTESİ  
PRE-RINSE FAUCET

Tezgaha Monte Ara Musluklu  
Table mounted, output-inverval valve



**INT-CC0019**

ÖN YIK.  
SPREY ÜNİTESİ  
PRE-RINSE FAUCET

Duvara Monte Klasik Wall  
Mounted



**INT-CC0020**

ÖN YIK.  
SPREY ÜNİTESİ  
PRE-RINSE FAUCET

Duvara Monte Ara Musluklu  
Wall mounted, output-inverval valve

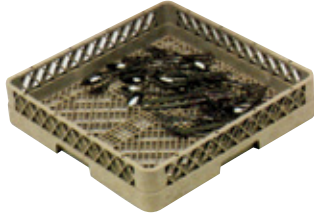

**ÇATAL BIÇAK KASETİ**  
CUTLERY RACK / RECTANGULAR WITH HANDLE



KOD	ÖLÇÜLER / DIMENSIONS
INT-UC0020	500 x 500 x 500 mm



**ÇATAL BIÇAK KONTEYNERİ** / DİKDÖRTGEN SAPLI  
CUTLERY RACK / RECTANGULAR HANDLE



KOD	ÖLÇÜLER / DIMENSIONS
INT-UC0021	205 x 425 x 150 mm

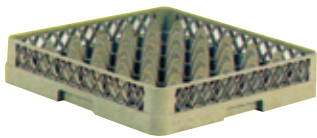

**BARDAK KASETİ** / 36 BÖLMELİ  
GLASS RACK / 36 SECTIONS



KOD	ÖLÇÜLER / DIMENSIONS
INT-UC0005	500 x 500 x 500 mm



**TABAK KASETİ**  
PLATE RACK



KOD	ÖLÇÜLER / DIMENSIONS
INT-UC0032	500 x 500 x 500 mm

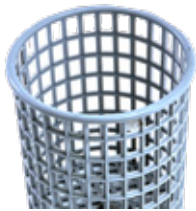

**INT-UC0019**

ÇATAL  
KAŞIKLIK APARATI  
CUTLERY KIT



**INT-UC0065**

TABAK YIKAMA  
APARATI  
PLATE KIT

OPSİYONEL OPTIONAL		Tabaklık, çatal kaşıklik Racks for plates & cutlery
DURULAMA POMP. MOT.GÜCÜ BOOSTER PUMP POWER	W	330
BOŞALTIMA POMP. MOT.GÜCÜ DRAINING PUMP POWER	W	30
DETERJAN POMPASI GÜCÜ DETERGENT PUMP POWER	W	8





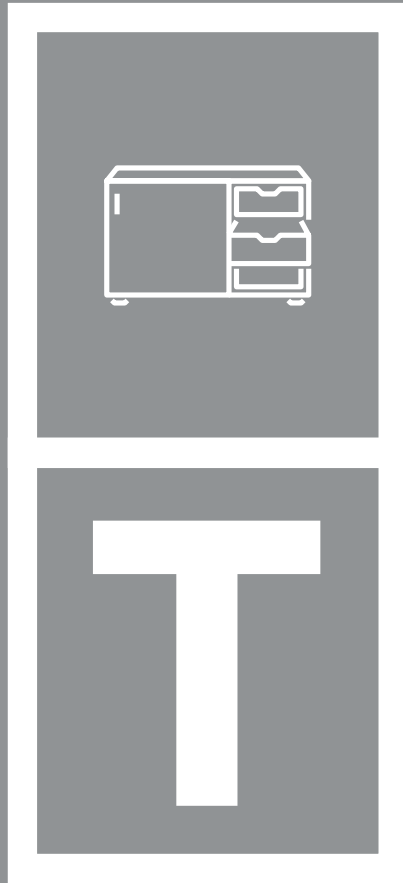

Tezgahlar  
Work Tables

# STANDART VE TREND SERİ TEZGAHLAR

STANDARD TABLES



- AISI304 kalite 18/8 Cr-Ni paslanmaz çelikten üretilmiştir.
- Ayaklar ve taşıyıcı konstrüksiyonda paslanmaz çelik profil kullanılmıştır.
- Model seçeneği çok geniştir.
- Üst tabla kullanım amacına göre, paslanmaz çelik, polietilen yada mermer olarak üretilmiştir.
- Hijyenik, kolay temizlenebilir ve montaj gerektirmeyen pratik kullanıma sahiptir.
- Fonksiyonel tasarımı ile depolama ve kullanım kolaylığı sağlar.
- Tezgah yüksekliği 82 cm ile 87 cm arasında ayarlanabilir.
- Üst tabla 1,2 mm

- Devices and equipment are manufactured from AISI304 grade 18/8 Cr/Ni stainless steel.
- Feet and support construction made from S/S profile.
- Wide selection of model options.
- Working surface can be made of stainless steel, polyethylene or marble according to usage.
- Hygienic, easy to clean and does not require assembly for convenient usage.
- Ease of use and storage with functional design.
- Height of tables can be adjusted between 82 cm and 87 cm.
- Top thickness 1,2 mm

**INO-TCT S**
**ÇALIŞMA TEZGAHI  
WORK TABLE**

**INO-TCN S**
**ÇALIŞMA TEZGAHI / ALT TABLALI  
WORK TABLE / LOWER SHELF**

**INO-TCC S**
**ÇALIŞMA TEZGAHI / TEK ÇEKMECELİ / ALT TABLALI  
WORK TABLE / SINGLE DRAWER / LOWER SHELF**

**INO-TCA S**
**ÇALIŞMA TEZGAHI / ARA RAFLI  
WORK TABLE / LOWER AND INTERMEDIATE SHELVES**

STANDART	TREND	ÖLÇÜLER / DIMENSIONS
INO-TCT096S	INO-TCT096T	900x600x850
INO-TCT116S	INO-TCT116T	1100x600x850
INO-TCT146S	INO-TCT146T	1400x600x850
INO-TCT166S	INO-TCT166T	1600x600x850
INO-TCT196S	INO-TCT196T	1900x600x850
INO-TCT090S	INO-TCT090T	900x700x850
INO-TCT110S	INO-TCT110T	1100x700x850
INO-TCT140S	INO-TCT140T	1400x700x850
INO-TCT160S	INO-TCT160T	1600x700x850
INO-TCT190S	INO-TCT190T	1900x700x850

STANDART	TREND	ÖLÇÜLER DIMENSIONS
INO-TCN096S	INO-TCN096T	900x600x850
INO-TCN116S	INO-TCN116T	1100x600x850
INO-TCN146S	INO-TCN146T	1400x600x850
INO-TCN166S	INO-TCN166T	1600x600x850
INO-TCN196S	INO-TCN196T	1900x600x850
INO-TCN090S	INO-TCN090T	900x700x850
INO-TCN110S	INO-TCN110T	1100x700x850
INO-TCN140S	INO-TCN140T	1400x700x850
INO-TCN160S	INO-TCN160T	1600x700x850
INO-TCN190S	INO-TCN190T	1900x700x850

STANDART SOL	STANDART SAĞ	TREND SOL	TREND SAĞ	ÖLÇÜLER DIMENSIONS
INO-TCC 096L S	INO-TCC 096R S	INO-TCC 096L T	INO-TCC 096R T	900x600x850
INO-TCC 146L S	INO-TCC 146R S	INO-TCC 146L T	INO-TCC 146R T	1400x600x850
INO-TCC 196L S	INO-TCC 196R S	INO-TCC 196L T	INO-TCC 196R T	1900x600x850
INO-TCC 090L S	INO-TCC 090R S	INO-TCC 090L T	INO-TCC 090R T	900x700x850
INO-TCC 140L S	INO-TCC 140R S	INO-TCC 140L T	INO-TCC 140R T	1400x700x850
INO-TCC 190L S	INO-TCC 190R S	INO-TCC 190L T	INO-TCC 190R T	1900x700x850

STANDART	TREND	ÖLÇÜLER DIMENSIONS
INO-TCA096S	INO-TCA096T	900x600x850
INO-TCA116S	INO-TCA116T	1100x600x850
INO-TCA146S	INO-TCA146T	1400x600x850
INO-TCA166S	INO-TCA166T	1600x600x850
INO-TCA196S	INO-TCA196T	1900x600x850
INO-TCA090S	INO-TCA090T	900x700x850
INO-TCA110S	INO-TCA110T	1100x700x850
INO-TCA140S	INO-TCA140T	1400x700x850
INO-TCA160S	INO-TCA160T	1600x700x850
INO-TCA190S	INO-TCA190T	1900x700x850

**INO-TC4 S**

**ÇALIŞMA TEZGAHI / 4 ÇEKMECELİ**  
**WORK TABLE / 4 DRAWERS / LOWER SHELF**



STANDART SOL	STANDART SAĞ	TREND SOL	TREND SAĞ	ÖLÇÜLER DIMENSIONS
INO-TC4 146L S	INO-TC4 146R S	INO-TC4 146L T	INO-TC4 146R T	1400x600x850
INO-TC4 196L S	INO-TC4 196R S	INO-TC4 196L T	INO-TC4 196R T	1900x600x850
INO-TC4 140L S	INO-TC4 140R S	INO-TC4 140L T	INO-TC4 140R T	1400x700x850
INO-TC4 190L S	INO-TC4 190R S	INO-TC4 190L T	INO-TC4 190R T	1900x700x850

**INO-TCR S**

**ÇALIŞMA TEZGAHI / 4 ÇEKMECELİ / ARA RAFLI**  
**WORK TABLE / 4 DRAWERS / LOWER AND**  
**INTERMEDIATE SHELVES**



STANDART SOL	STANDART SAĞ	TREND SOL	TREND SAĞ	ÖLÇÜLER DIMENSIONS
INO-TCR 146L S	INO-TCR 146R S	INO-TCR 146L T	INO-TCR 146R T	1400x600x850
INO-TCR 196L S	INO-TCR 196R S	INO-TCR 196L T	INO-TCR 196R T	1900x600x850
INO-TCR 140L S	INO-TCR 140R S	INO-TCR 140L T	INO-TCR 140R T	1400x700x850
INO-TCR 190L S	INO-TCR 190R S	INO-TCR 190L T	INO-TCR 190R T	1900x700x850

**INO-TCD S**
**ÇALIŞMA TEZGAHI / DOLAPLI  
WORK TABLE / CUPBOARD**

 Özel ölçü imal edilemez  
Custom dimensions are not available

STANDART	TREND	ÖLÇÜLER DIMENSIONS
INO-TCD116S	INO-TCD116T	1100x600x850
INO-TCD146S	INO-TCD146T	1400x600x850
INO-TCD166S	INO-TCD166T	1600x600x850
INO-TCD196S	INO-TCD196T	1900x600x850
INO-TCD110S	INO-TCD110T	1100x700x850
INO-TCD140S	INO-TCD140T	1400x700x850
INO-TCD160S	INO-TCD160T	1600x700x850
INO-TCD190S	INO-TCD190T	1900x700x850

**INO-TCS S**
**ÇALIŞMA TEZGAHI / DOLAPLI / ARA RAFLI  
WORK TABLE / CUPBOARD / INTERMEDIATE SHELF**

 Özel ölçü imal edilemez  
Custom dimensions are not available

STANDART	TREND	ÖLÇÜLER DIMENSIONS
INO-TCS116S	INO-TCS116T	1100x600x850
INO-TCS146S	INO-TCS146T	1400x600x850
INO-TCS166S	INO-TCS166T	1600x600x850
INO-TCS196S	INO-TCS196T	1900x600x850
INO-TCS110S	INO-TCS110T	1100x700x850
INO-TCS140S	INO-TCS140T	1400x700x850
INO-TCS160S	INO-TCS160T	1600x700x850
INO-TCS190S	INO-TCS190T	1900x700x850

**INO-TCG S**
**ÇALIŞMA TEZGAHI / DOLAPLI / ARA RAFLI / 4 ÇEKMECELİ  
WORK TABLE / CUPBOARD  
INTERMEDIATE SHELF / 4 DRAWERS**

 Özel ölçü imal edilemez  
Custom dimensions are not available

STANDART SOL	STANDART SAĞ	TREND SOL	TREND SAĞ	ÖLÇÜLER DIMENSIONS
INO-TCG 146L S	INO-TCG 146R S	INO-TCG 146L T	INO-TCG 146R T	1400x600x850
INO-TCG 146L S	INO-TCG 146R S	INO-TCG 146L T	INO-TCG 146R T	1400x600x850
INO-TCG 196L S	INO-TCG 196R S	INO-TCG 196L T	INO-TCG 196R T	1900x600x850
INO-TCG 196L S	INO-TCG 196R S	INO-TCG 196L T	INO-TCG 196R T	1900x600x850
INO-TCG 140L S	INO-TCG 140R S	INO-TCG 140L T	INO-TCG 140R T	1400x700x850
INO-TCG 140L S	INO-TCG 140R S	INO-TCG 140L T	INO-TCG 140R T	1400x700x850
INO-TCG 190L S	INO-TCG 190R S	INO-TCG 190L T	INO-TCG 190R T	1900x700x850
INO-TCG 190L S	INO-TCG 190R S	INO-TCG 190L T	INO-TCG 190R T	1900x700x850

**INO-TPT S**
**POLİETİLEN TABLALI TEZGAH  
POLYETHYLENE TOP TABLE**

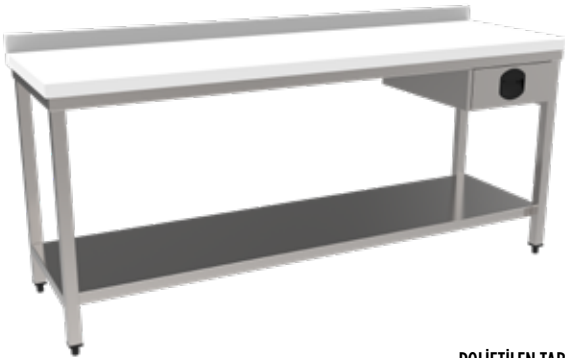
**INO-TPN S**
**POLİETİLEN TABLALI TEZGAHLAR / ALT TABLALI  
POLYETHYLENE TOP TABLE / LOWER SHELF**

**INO-TPC S**
**POLİETİLEN TABLALI TEZGAHLAR  
TEK ÇEKMECELİ / ALT TABLALI  
POLYETHYLENE TOP TABLE / SINGLE DRAWER / LOWER SHELF**

STANDART	TREND	ÖLÇÜLER DIMENSIONS
INO-TPT116S	INO-TPT116T	1100x600x850
INO-TPT146S	INO-TPT146T	1400x600x850
INO-TPT166S	INO-TPT166T	1600x600x850
INO-TPT196S	INO-TPT196T	1900x600x850
INO-TPT110S	INO-TPT110T	1100x700x850
INO-TPT140S	INO-TPT140T	1400x700x850
INO-TPT160S	INO-TPT160T	1600x700x850
INO-TPT190S	INO-TPT190T	1900x700x850

Beyaz, sarı, yeşil, mavi, kırmızı ve kahverengi renklerinde imal edilebilir.

Polyethylene top available for white, yellow, blue, red and brown colours.

STANDART	TREND	ÖLÇÜLER DIMENSIONS
INO-TPN116S	INO-TPN116T	1100x600x850
INO-TPN146S	INO-TPN146T	1400x600x850
INO-TPN166S	INO-TPN166T	1600x600x850
INO-TPN196S	INO-TPN196T	1900x600x850
INO-TPN110S	INO-TPN110T	1100x700x850
INO-TPN140S	INO-TPN140T	1400x700x850
INO-TPN160S	INO-TPN160T	1600x700x850
INO-TPN190S	INO-TPN190T	1900x700x850

Beyaz, sarı, yeşil, mavi, kırmızı ve kahverengi renklerinde imal edilebilir.

Polyethylene top available for white, yellow, blue, red and brown colours.

STANDART SOL	STANDART SAĞ	TREND SOL	TREND SAĞ	ÖLÇÜLER DIMENSIONS
INO-TPC116L S	INO-TPC116R S	INO-TPC116L T	INO-TPC116R T	1100x600x850
INO-TPC146L S	INO-TPC146R S	INO-TPC146L T	INO-TPC146R T	1400x600x850
INO-TPC166L S	INO-TPC166R S	INO-TPC166L T	INO-TPC166R T	1600x600x850
INO-TPC196L S	INO-TPC196R S	INO-TPC196L T	INO-TPC196R T	1900x600x850
INO-TPC110L S	INO-TPC110R S	INO-TPC110L T	INO-TPC110R T	1100x700x850
INO-TPC140L S	INO-TPC140R S	INO-TPC140L T	INO-TPC140R T	1400x700x850
INO-TPC160L S	INO-TPC160R S	INO-TPC160L T	INO-TPC160R T	1600x700x850
INO-TPC190L S	INO-TPC190R S	INO-TPC190L T	INO-TPC190R T	1900x700x850

Beyaz, sarı, yeşil, mavi, kırmızı ve kahverengi renklerinde imal edilebilir.

Polyethylene top available for white, yellow, blue, red and brown colours.

**INO-TPB S**

**POLİETİLEN TABLALI TEZGAHLAR**  
4 ÇEKMECELİ / ALT TABLALI  
**POLYETHYLENE TOP TABLE / 4 DRAWERS / LOWER SHELF**



STANDART SOL	STANDART SAĞ	TREND SOL	TREND SAĞ	ÖLÇÜLER DIMENSIONS
INO-TPB 146L S	INO-TPB 146R S	INO-TPB 146L T	INO-TPB 146R T	1400x600x850
INO-TPB 196L S	INO-TPB 196R S	INO-TPB 196L T	INO-TPB 196R T	1900x600x850
INO-TPB 140L S	INO-TPB 140R S	INO-TPB 140L T	INO-TPB 140R T	1400x700x850
INO-TPB 190L S	INO-TPB 190R S	INO-TPB 190L T	INO-TPB 190R T	1900x700x850

Beyaz, sarı, yeşil, mavi, kırmızı ve kahverengi renklerinde imal edilebilir.

Polyethylene top available for white, yellow, blue, red and brown colours.

**INO-TMT S**

**MERMER TABLALI TEZGAHLAR**  
**MARBLE TOP TABLE**



STANDART	TREND	ÖLÇÜLER DIMENSIONS
INO-TMT140S	INO-TMT140T	1400x700x850
INO-TMT160S	INO-TMT160T	1600x700x850
INO-TMT190S	INO-TMT190T	1900x700x850
INO-TMT148S	INO-TMT148T	1400x800x850
INO-TMT168S	INO-TMT168T	1600x800x850
INO-TMT198S	INO-TMT198T	1900x800x850
INO-TMT142S	INO-TMT 142T	1400x1100x850
INO-TMT162S	INO-TMT162T	1600x1100x850
INO-TMT192S	INO-TMT192T	1900x1100x850

"Eni 1100 mm olan tezgahlar sırtsız olarak imal edilir."  
1100mm depth tables without splashback

**INO-TMN S**

**MERMER TABLALI TEZGAHLAR / ALT TABLALI**  
**MARBLE TOP TABLE / LOWER SHELF**



STANDART	TREND	ÖLÇÜLER DIMENSIONS
INO-TMN140S	INO-TMN140T	1400x700x850
INO-TMN160S	INO-TMN160T	1600x700x850
INO-TMN190S	INO-TMN190T	1900x700x850
INO-TMN148S	INO-TMN148T	1400x800x850
INO-TMN168S	INO-TMN168T	1600x800x850
INO-TMN198S	INO-TMN198T	1900x800x850
INO-TMN142S	INO-TMN142T	1400x1100x850
INO-TMN162S	INO-TMN162T	1600x1100x850
INO-TMN192S	INO-TMN192T	1900x1100x850

"Eni 1100 mm olan tezgahlar sırtsız olarak imal edilir."  
1100mm depth tables without splashback

**INO-TMC S**

**MERMER TABLALI TEZGAHLAR**  
ALT TABLALI / TEK ÇEKMECELİ  
**MARBLE TOP TABLE / SINGLE DRAWER / LOWER SHELF**

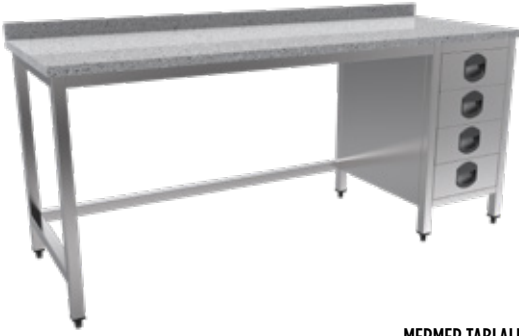
**INO-TM4 S**

**MERMER TABLALI TEZGAHLAR / 4 ÇEKMECELİ**  
**MARBLE TOP TABLE / 4 DRAWERS**

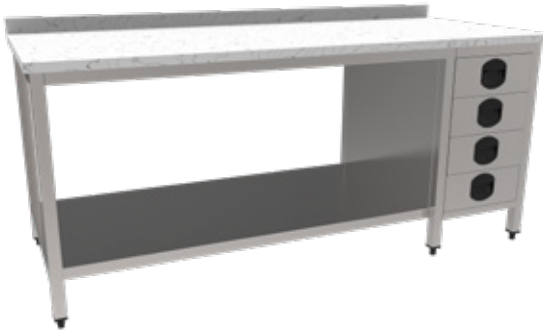
**INO-TMB S**

**MERMER TABLALI TEZGAHLAR**  
ALT TABLALI / 4 ÇEKMECELİ  
**MARBLE TOP TABLE / 4 DRAWERS / LOWER SHELF**



STANDART SOL	STANDART SAĞ	TREND SOL	TREND SAĞ	ÖLÇÜLER DIMENSIONS
INO-TMC 140L S	INO-TMC 140R S	INO-TMC 140LT	INO-TMC 140RT	1400x700x850
INO-TMC 160L S	INO-TMC 160R S	INO-TMC 160LT	INO-TMC 160RT	1600x700x850
INO-TMC 190L S	INO-TMC 190R S	INO-TMC 190LT	INO-TMC 190RT	1900x700x850
INO-TMC 148L S	INO-TMC 148R S	INO-TMC 148LT	INO-TMC 148RT	1400x800x850
INO-TMC 168L S	INO-TMC 168R S	INO-TMC 168LT	INO-TMC 168RT	1600x800x850
INO-TMC 198L S	INO-TMC 198R S	INO-TMC 198LT	INO-TMC 198RT	1900x800x850
INO-TMC 142 S	-	INO-TMC 142T	-	1400x1100x850
INO-TMC 162 S	-	INO-TMC 162 T	-	1600x1100x850
INO-TMC 192 S	-	INO-TMC 192T	-	1900x1100x850

"Eni 1100 mm olan tezgahlar sırtsız olarak imal edilir."  
1100mm depth tables without splashback

STANDART SOL	STANDART SAĞ	TREND SOL	TREND SAĞ	ÖLÇÜLER DIMENSIONS
INO-TM4 140L S	INO-TM4 140R S	INO-TM4 140LT	INO-TM4 140RT	1400x700x850
INO-TM4 160L S	INO-TM4 160R S	INO-TM4 160LT	INO-TM4 160RT	1600x700x850
INO-TM4 190L S	INO-TM4 190R S	INO-TM4 190LT	INO-TM4 190RT	1900x700x850
INO-TM4 148L S	INO-TM4 148R S	INO-TM4 148LT	INO-TM4 148RT	1400x800x850
INO-TM4 168L S	INO-TM4 168R S	INO-TM4 168LT	INO-TM4 168RT	1600x800x850
INO-TM4 198L S	INO-TM4 198R S	INO-TM4 198LT	INO-TM4 198RT	1900x800x850
INO-TM4 142 S	INO-TM4 142 S	INO-TM4 142T	INO-TM4 142 T	1400x1100x850
INO-TM4 162 S	INO-TM4 162 S	INO-TM4 162 T	INO-TM4 162 T	1600x1100x850
INO-TM4 192 S	INO-TM4 192 S	INO-TM4 192 T	INO-TM4 192 T	1900x1100x850

"Eni 1100 mm olan tezgahlar sırtsız olarak imal edilir."  
1100mm depth tables without splashback

STANDART SOL	STANDART SAĞ	TREND SOL	TREND SAĞ	ÖLÇÜLER DIMENSIONS
TMB 140L S	TMB 140R S	TMB 140LT	TMB 140RT	1400x700x850
TMB 160L S	TMB 160R S	TMB 160LT	TMB 160RT	1600x700x850
TMB 190L S	TMB 190R S	TMB 190LT	TMB 190RT	1900x700x850
TMB 148L S	TMB 148R S	TMB 148LT	TMB 148RT	1400x800x850
TMB 168L S	TMB 168R S	TMB 168LT	TMB 168RT	1600x800x850
TMB 198L S	TMB 198R S	TMB 198LT	TMB 198RT	1900x800x850
TMB 142 S	TMB 142 S	TMB 142 T	TMB 142 T	1400x1100x850
TMB 162 S	TMB 162 S	TMB 162 T	TMB 162 T	1600x1100x850
TMB 192 S	TMB 192 S	TMB 192 T	TMB 192 T	1900x1100x850

"Eni 1100 mm olan tezgahlar sırtsız olarak imal edilir."  
1100mm depth tables without splashback

**INO-TMS S**

**MERMER TABLALI TEZGAHLAR / ARA RAFLI / DOLAPLI**  
**MARBLE TOP TABLE / CUPBOARD / INTERMEDIATE SHELF**

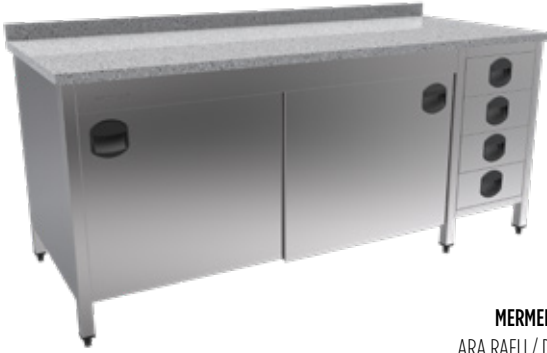

STANDART	TREND	ÖLÇÜLER DIMENSIONS
INO-TMS140S	INO-TMS140T	1400x700x850
INO-TMS160S	INO-TMS160T	1600x700x850
INO-TMS190S	INO-TMS190T	1900x700x850
INO-TMS148S	INO-TMS148T	1400x800x850
INO-TMS168S	INO-TMS168T	1600x800x850
INO-TMS198S	INO-TMS198T	1900x800x850
INO-TMS142S	INO-TMS142T	1400x1100x850
INO-TMS162S	INO-TMS162T	1600x1100x850
INO-TMS192S	INO-TMS192T	1900x1100x850

**INO-TMG S**

**MERMER TABLALI TEZGAHLAR**  
**ARA RAFLI / DOLAPLI / 4 ÇEKMECELİ**  
**MARBLE TOP TABLE / CUPBOARD / 4 DRAWERS /**  
**INTERMEDIATE SHELF**



STANDART SOL	STANDART SAĞ	TREND SOL	TREND SAĞ	ÖLÇÜLER DIMENSIONS
INO-TMG 190L S	INO-TMG 190R S	INO-TMG 190L T	INO-TMG 190R T	1900x700x850
INO-TMG 198L S	INO-TMG 198R S	INO-TMG 198L T	INO-TMG 198R T	1900x800x850
INO-TMG 192L S	INO-TMG 192R S	INO-TMG 192L T	INO-TMG 192R T	1900x1100x850

**INO-TCN HS**

**HAREKETLİ ÇALIŞMA TEZGAHLARI / ALT TABLALI**  
**MOBILE TABLE / LOWER SHELF**



STANDART	TREND	ÖLÇÜLER DIMENSIONS
INO-TCN16HS	INO-TCN16HT	1100x600x850
INO-TCN146HS	INO-TCN146HT	1400x600x850
INO-TCN166HS	INO-TCN166HT	1600x600x850
INO-TCN110HS	INO-TCN110HT	1100x700x850
INO-TCN140HS	INO-TCN140HT	1400x700x850
INO-TCN160HS	INO-TCN160HT	1600x700x850



**INO-TCA HS**

**HAREKETLİ ÇALIŞMA TEZGAHLARI / ARA RAFLI  
MOBILE TABLE / LOWER AND INTERMEDIATE SHELVES**



STANDART	TREND	ÖLÇÜLER DIMENSIONS
INO-TCA116HS	INO-TCA116HT	1100x600x850
INO-TCA146HS	INO-TCA146HT	1400x600x850
INO-TCA166HS	INO-TCA166HT	1600x600x850
INO-TCA110HS	INO-TCA110HT	1100x700x850
INO-TCA140HS	INO-TCA140HT	1400x700x850
INO-TCA160HS	INO-TCA160HT	1600x700x850



**INO-TCC HS**

**HAREKETLİ ÇALIŞMA TEZGAHLARI / TEK ÇEKMECELİ  
MOBILE TABLE / SINGLE DRAWER / LOWER SHELF**



STANDART SOL	STANDART SAĞ	TREND SOL	TREND SAĞ	ÖLÇÜLER DIMENSIONS
INO-TCC116HLS	INO-TCC116HRS	INO-TCC116HLT	INO-TCC116HRT	1100x600x850
INO-TCC146HLS	INO-TCC146HRS	INO-TCC146HLT	INO-TCC146HRT	1400x600x850
INO-TCC110HLS	INO-TCC110HRS	INO-TCC110HLT	INO-TCC110HRT	1100x700x850
INO-TCC140HLS	INO-TCC140HRS	INO-TCC140HLT	INO-TCC140HRT	1400x700x850
INO-TCC160HLS	INO-TCC160HRS	INO-TCC160HLT	INO-TCC160HRT	1600x700x850



**TEP**

**TEZGAHLAR  
ET KÜTÜĞÜ / POLİETİLEN TABLALI  
MEAT CHOPPING BLOCK /  
POLYETHYLENE TOP**



MODEL	ÖLÇÜLER DIMENSIONS
INO-TEP 066	600x600x850
INO-TEP 070	700x700x850
INO-TEP 088	800x800x850

Beyaz, sarı, yeşil, mavi, kırmızı ve kahverengi renklerinde imal edilebilir.

Polyethylene top available for white, yellow, blue, red and brown colours.



THF120



THF180

**INO-THF**

**TEZGAHLAR / BALIK HAZIRLIK TEZGAHI  
FISH PREPARATION TABLE**



MODEL	ÖLÇÜLER DIMENSIONS
INO-THF 120	1200x700x850
INO-THF 180	1800x700x850

TEZGAHLAR / ÇALIŞMA TEZGAHLARI  
TABLES / WORK TABLES

**INO-NTS S**
**BAR-CAFE TEZGAHLARI / SÜZME RAFLI  
BAR-CAFE TABLES / WITH DRAIN SHELVES**

MODEL	ÖLÇÜLER / DIMENSIONS
INO-NTS 060 S	600x600x850
INO-NTS 080 S	800x600x850
INO-NTS 100 S	1000x600x850
INO-NTS 120 S	1200x600x850

**INO-NTD S**
**BAR-CAFE TEZGAHLARI  
DOLAPLI / ÇARPMA KAPILI  
BAR-CAFE TABLES /  
CUPBOARD WITH HINGED DOORS**

MODEL	ÖLÇÜLER / DIMENSIONS
INO-NTD 040C S	400x600x850
INO-NTD 060C S	600x600x850
INO-NTD 080C S	800x600x850
INO-NTD 100C S	1000x600x850
INO-NTD 120C S	1200x600x850

**INO-NT1040S /  
INO-NT4040S**

**BAR-CAFE TEZGAHLARI / ÇEKMECELİ  
BAR-CAFE TABLES / COCKTAIL TABLE**

MODEL		ÖLÇÜLER / DIMENSIONS
INO-NT1040S	INO-NT1040	470x600x850
INO-NT4040S	INO-NT4040	470x600x850

**INO-NTR060S / INO-NTR065S**

**BAR-CAFE TEZGAHLARI  
KASET RAYLI  
BAR-CAFE TABLES  
WITH BASKET RAIL**

MODEL		ÖLÇÜLER / DIMENSIONS
INO-NTR060S	INO-NTR060	620x600x850
INO-NTR065S	INO-NTR065	650x600x850

**INO-NTK**
**BAR-CAFE TEZGAHLARI  
KÖSE TEZGAHI  
BAR-CAFE TABLES / CORNER TABLE**

MODEL	ÖLÇÜLER
INO-NTK 030D	30° Dış
INO-NTK 030I	30° İç
INO-NTK 045D	45° Dış
INO-NTK 045I	45° İç
INO-NTK 060D	60° Dış
INO-NTK 060I	60° İç
INO-NTK 090D	90° Dış
INO-NTK 090I	90° İç

**INO-NKB**
**BLENDER TEZGAHI  
BAR-CAFE TABLES /  
BLENDER TABLE**

MODEL	ÖLÇÜLER
INO-NKB 040	400x600x850
INO-NKB 060	600x600x850

**İLAVELER / ADDITIONALS**

MODEL	ÖLÇÜLER / DIMENSIONS
2041020040	Tek Çekmece / Single drawer
2041020230	4 Çekmece ( 700mm enindeki tezgahlar için ) / 4 drawers ( for 700mm depth tables )
2041020220	4 Çekmece ( 600mm enindeki tezgahlar için ) / 4 drawers ( for 600mm depth tables )
2041020240	4 Çekmece ( 800mm enindeki tezgahlar için ) / 4 drawers ( for 800mm depth tables )
2041002007	Ara Raf İlavesi, 900x600 çalışma tezgahı için, Alt tabla ilavesi / Intermediate / lower shelf, for 900x600 work tables
2041002027	Ara Raf İlavesi, 1100x600 çalışma tezgahı için, Alt tabla ilavesi / Intermediate / lower shelf, for 1100x600 work tables
2041002057	Ara Raf İlavesi, 1400x600 çalışma tezgahı için, Alt tabla ilavesi / Intermediate / lower shelf, for 1400x600 work tables
2041002107	Ara Raf İlavesi, 1900x600 çalışma tezgahı için, Alt tabla ilavesi / Intermediate / lower shelf, for 1900x600 work tables
2041002187	Ara Raf İlavesi, 1100x700 çalışma tezgahı için, Alt tabla ilavesi / Intermediate / lower shelf, for 1100x700 work tables
2041002217	Ara Raf İlavesi, 900x700 çalışma tezgahı için, Alt tabla ilavesi / Intermediate / lower shelf, for 900x700 work tables
2041002267	Ara Raf İlavesi, 1900x700 çalışma tezgahı için, Alt tabla ilavesi / Intermediate / lower shelf, for 1900x700 work tables
2041002327	Ara Raf İlavesi, 900x800 çalışma tezgahı için, Alt tabla ilavesi / Intermediate / lower shelf, for 900x800 work tables

**INO-NTB S**
**PREMIX TEZGAHI  
BAR-CAFE TABLES / PREMIX TABLE**

MODEL	ÖLÇÜLER
INO-NTB 060 S	INO-NTB 060 600x600x850
INO-NTB 080 S	INO-NTB 080 800x600x850
INO-NTB 100 S	INO-NTB 100 1000x600x850
INO-NTB 120 S	INO-NTB 120 1200x600x850
INO-NTB 140 S	INO-NTB 140 1400x600x850

MODEL	ÖLÇÜLER / DIMENSIONS
2041002347	Ara Raf İlavesi, 1100x800 çalışma tezgahı için, Alt tabla ilavesi / Intermediate / lower shelf, for 1100x800 work tables
2041002377	Ara Raf İlavesi, 1400x800 çalışma tezgahı için, Alt tabla ilavesi / Intermediate / lower shelf, for 1400x800 work tables
2041002427	Ara Raf İlavesi, 1900x800 çalışma tezgahı için, Alt tabla ilavesi / Intermediate / lower shelf, for 1900x800 work tables
2041020357	Ara Raf İlavesi, 1900x600 çekmeceli çalışma tezgahı için / Intermediate / lower shelf, for 1900x600 work tables with drawer
2041020407	Ara Raf İlavesi, 2400x600 çekmeceli çalışma tezgahı için / Intermediate / lower shelf, for 2400x600 work tables with drawer
2041020557	Ara Raf İlavesi, 1900x700 çekmeceli çalışma tezgahı için / Intermediate / lower shelf, for 1900x700 work tables with drawer
2041020607	Ara Raf İlavesi, 2400x700 çekmeceli çalışma tezgahı için / Intermediate / lower shelf, for 2400x700 work tables with drawer
2041020757	Ara Raf İlavesi, 1900x800 çekmeceli çalışma tezgahı için / Intermediate / lower shelf, for 1900x800 work tables with drawer
2041020807	Ara Raf İlavesi, 2400x800 çekmeceli çalışma tezgahı için / Intermediate / lower shelf, for 2400x800 work tables with drawer
2041030357	Ara Raf İlavesi, 1400x600 dolaplı çalışma tezgahı için / Intermediate / lower shelf, for 1400x600 work tables with drawer
2041030407	Ara Raf İlavesi, 1900x600 dolaplı çalışma tezgahı için / Intermediate / lower shelf, for 1900x600 work tables with drawer
2041030557	Ara Raf İlavesi, 1400x700 dolaplı çalışma tezgahı için / Intermediate / shelf, for 1400x700 work tables with drawer
2041030607	Ara Raf İlavesi, 1900x700 dolaplı çalışma tezgahı için / Intermediate / shelf, for 1900x700 work tables with drawer
2041030757	Ara Raf İlavesi, 1400x800 dolaplı çalışma tezgahı için / Intermediate / shelf, for 1400x800 work tables with drawer
2041030807	Ara Raf İlavesi, 1900x800 dolaplı çalışma tezgahı için / Intermediate / shelf, for 1900x800 work tables with drawer
2041032010	Dolap ilavesi 1100x600 / Cupboard additional 1100x600
2041032021	Dolap ilavesi 1400x600 / Cupboard additional 1400x600
2041032050	Dolap ilavesi 1900x600 / Cupboard additional 1900x600
2041032110	Dolap ilavesi 1100x700 / Cupboard additional 1100x700
2041032121	Dolap ilavesi 1400x700 / Cupboard additional 1400x700
2041032150	Dolap ilavesi 1900x700 / Cupboard additional 1900x700
2041032210	Dolap ilavesi 1100x800 / Cupboard additional 1100x800
2041032221	Dolap ilavesi 1400x800 / Cupboard additional 1400x800
2041032250	Dolap ilavesi 1900x800 / Cupboard additional 1900x800
2041002510	Arka sac ilavesi 1100mm / Back sheet additional for 1100 mm
2041002511	Arka sac ilavesi 1400mm / Back sheet additional for 1400
2041002512	Arka sac ilavesi 1900mm / Back sheet additional for 1900 mm
2041002530	Niş ilavesi, alt tablasız / Niche addition for tables without undershelf
2041002533	Niş ilavesi, dolaplı (TCD seri hariç) / Niche addition for tables with cupboard (excl. TCD models)
2041002534	Niş ilavesi, dolaplı, ara rafı (TCS/TCD hariç) / Niche addition for table with cupboard & middle shelf (excl. TCS & TCG models)
2041002532	Niş ilavesi, ara rafı / Niche addition for tables with middle shelf
2041002531	Niş ilavesi, alt tablalı / Niche addition for tables with undershelf
2041002520	Ölü alan ilavesi (TCD ve TCG seri hariç) / Idle space addition (excl. TCD & TCG models)
2041002521	Ölü alan ilavesi (TCD ve TCG seri hariç) / Idle space addition (excl. TCD & TCG models)
2041002522	Ölü alan ilavesi (TCD ve TCG seri hariç) / Idle space addition (excl. TCD & TCG models)
2041002972	Yan sırt ilavesi / Side splashback
2041002973	Yan sırt ilavesi / Side splashback
2041002974	Yan sırt ilavesi / Side splashback
2041002500	Yan sac ilavesi / Side sheet
2041002501	Yan sac ilavesi / Side sheet
2041002502	Yan sac ilavesi / Side sheet
2041002976	Tekerlek tablalı 125x32 mm (Alt tablalı tezgahlar için) / Wheel set, 125x32mm (for tables with lower shelf)
2041002975	Tekerlek millili 125x32 mm (Alt tablasız tezgahlar için) / Wheel set, 125x32mm (for tables without lower shelf)
2041020243	Kilit ilavesi, tek kilit için / Lock (single)
2041020902	Kapı ilavesi (1100mm çal. tez. için) / Door (for 1100mm work tables)
2041020903	Kapı ilavesi (1400mm çal. tez. için) / Door (for 1400mm work tables)
2041020904	Kapı ilavesi (1900mm çal. tez. için) / Door (for 1900mm work tables)

# EVİYELİ TEZGAHLAR

## SINK UNITS



- Tamamı AISI304 kalite 18/8 Cr-Ni paslanmaz çelikten üretilmiştir.
- Ayaklar ve taşıyıcı konstrüksiyonda paslanmaz çelik profil kullanılmıştır.
- Model seçeneği çok geniştir.
- Tüm modellerde küvetler pres baskılı olup bazı modellerde üst tabla ve küvetler tek parça halinde pres baskılı ve damlalıklı olarak üretilmiştir.
- Hijyenik, kolay temizlenebilir ve montaj gerektirmeyen pratik kullanıma sahiptir.

- All devices and equipment are manufactured from AISI304 grade 18/8 Cr/Ni stainless steel.
- Stainless steel profile is used in feet and support construction
- Wide selection of model options.
- All standard units are produced with pressing method. In some models working surface and sinks are monoblock with pressing method and drainboard.
- Hygienic, easy to clean and does not require assembly for convenient usage.

**INO-EIN**
**EVİYELİ TEZGAHLAR / TEK KÜVET TEZGAH**  
**SINK UNIT / SINGLE SINK**

MODEL	KÜVET / SINK	ÖLÇÜLER DIMENSIONS
INO-EIN 066	(400x400x250)	600x600x850
INO-EIN 060	(400x500x250)	600x700x850
INO-EIN 070	(500x500x300)	700x700x850

**INO-EIN**
**EVİYELİ TEZGAHLAR**  
**TEK KÜVET TEZGAH / DAMLALIKLI**  
**SINK UNIT SINGLE SINK / DRAIN BOARD**

MODEL	MODEL	KÜVET / SINK	ÖLÇÜLER DIMENSIONS
INO-EIN 106L	INO-EIN 106R	(400x400x250)	1000x600x850
INO-EIN 126L	INO-EIN 126R	(400x400x250)	1200x600x850
INO-EIN 146L	INO-EIN 146R	(500x400x250)	1400x600x850
INO-EIN 100L	INO-EIN 100R	(500x500x300)	1000x700x850
INO-EIN 120L	INO-EIN 120R	(500x500x300)	1200x700x850
INO-EIN 140L	INO-EIN 140R	(500x500x300)	1400x700x850
INO-EIN 160L	INO-EIN 160R	(500x500x300)	1600x700x850

**INO-EID**
**EVİYELİ TEZGAHLAR**  
**TEK KÜVET TEZGAH / DOLAPLI**  
**SINK UNIT SINGLE SINK / CUPBOARD**

MODEL	MODEL	KÜVET / SINK	ÖLÇÜLER DIMENSIONS
INO-EID 066L	INO-EID 066R	(400x400x250)	600x600x850
INO-EID 106L	INO-EID 106R	(400x400x250) Damlalıklı	1000x600x850
INO-EID 126L	INO-EID 126R	(500x500x300) Damlalıklı	1200x600x850
INO-EID 060L	INO-EID 060R	(400x400x250)	600x700x850
INO-EID 070L	INO-EID 070R	(400x400x250)	700x700x850
INO-EID 120L	INO-EID 120R	(400x400x250) Damlalıklı	1200x700x850



**INO-E2N**

**EVİYELİ TEZGAHLAR / İKİ KÜVET TEZGAH**  
**SINK UNIT / DOUBLE SINK**



MODEL	KÜVET / SINK	ÖLÇÜLER DIMENSIONS
INO-E2N 126	(500x400x250)	1200x600x850
INO-E2N 120	(500x500x300)	1200x700x850
INO-E2N 140	(500x500x300)	1400x700x850



**INO-E2N**

**EVİYELİ TEZGAHLAR**  
**İKİ KÜVET TEZGAH / DAMLALIKLI**  
**SINK UNIT DOUBLE SINK / DRAIN BOARD**



MODEL	MODEL	KÜVET / SINK	ÖLÇÜLER DIMENSIONS
INO-E2N 146L	INO-E2N 146R	(400x400x250)	1400x600x850
INO-E2N 166L	INO-E2N 166R	(500x400x250)	1600x600x850
INO-E2N 188L	INO-E2N 188R	(500x400x250)	1800x600x850
INO-E2N 160L	INO-E2N 160R	(500x500x300)	1600x700x850
INO-E2N 180L	INO-E2N 180R	(500x500x300)	1800x700x850



**INO-E3N**

**EVİYELİ TEZGAHLAR**  
**ÜÇ KÜVET TEZGAH / PRES TABLALI**  
**SINK UNIT TRIPLE SINK / PRESSED TOP**



MODEL	KÜVET / SINK	ÖLÇÜLER DIMENSIONS
INO-E3N 186	(500x400x250)	1800x600x850
INO-E3N 180	(500x500x300)	1800x700x850

**INO-ED1**

**EVIYELİ TEZGAHLAR**  
TEK KÜVET TEZGAH / DERİN  
SINK UNIT SINGLE DEEP SINK



MODEL	MODEL	KÜVET / SINK	ÖLÇÜLER DIMENSIONS
INO-ED 1120	-	960x510x380	1200x700x850

**INO-ED2**

**EVIYELİ TEZGAHLAR**  
İKİ KÜVET TEZGAH / DERİN  
SINK UNIT DOUBLE DEEP SINK



MODEL	MODEL	KÜVET SINK	ÖLÇÜLER DIMENSIONS
INO-ED 2160	-	700x500x400	1600x700x850
INO-ED 2190	-	700x500x400	1900x700x850

**INO-EHN**

**TEZGAH / SÜZME HAVUZLU TEZGAH**  
TABLE WITH DRAINING WELL

Kaynaklı / welded  
Pres / pressed  
Pres / pressed  
Pres / pressed  
Kaynaklı / welded  
Kaynaklı / welded

MODEL	ÖLÇÜLER DIMENSIONS
INO-EHN 106	1000x600x850
INO-EHN 126	1200x600x850
INO-EHN 146	1400x600x850
INO-EHN 166	1600x600x850
INO-EHN 186	1800x600x850
INO-EHN 206	2000x600x850

MODEL	ÖLÇÜLER DIMENSIONS
INO-EHN 100	1000x700x850
INO-EHN 120	1200x700x850
INO-EHN 140	1400x700x850
INO-EHN 160	1600x700x850
INO-EHN 180	1800x700x850
INO-EHN 200	2000x700x850

**INO-ESN**

**SÜZME TEZGAHI**  
DRAINING TABLE



MODEL	ÖLÇÜLER DIMENSIONS
INO-ESN 106	1000x600x850
INO-ESN 126	1200x600x850
INO-ESN 146	1400x600x850
INO-ESN 166	1600x600x850
INO-ESN 186	1800x600x850
INO-ESN 206	2000x600x850

MODEL	ÖLÇÜLER DIMENSIONS
INO-ESN 100	1000x700x850
INO-ESN 120	1200x700x850
INO-ESN 140	1400x700x850
INO-ESN 160	1600x700x850
INO-ESN 180	1800x700x850
INO-ESN 200	2000x700x850

**INO-EBN**
**BULAŞIK SIYIRMA TEZGAHI  
SCRAPPING TABLE**

MODEL	ÖLÇÜLER DIMENSIONS
INO-EBN 106	1000x600x850
INO-EBN 126	1200x600x850
INO-EBN 146	1400x600x850
INO-EBN 166	1600x600x850
INO-EBN 186	1800x600x850
INO-EBN 206	2000x600x850

MODEL	ÖLÇÜLER DIMENSIONS
INO-EBN 100	1000x700x850
INO-EBN 120	1200x700x850
INO-EBN 140	1400x700x850
INO-EBN 160	1600x700x850
INO-EBN 180	1800x700x850
INO-EBN 200	2000x700x850

**INO-EKN**
**KAZAN YIKAMA EVİYESİ İZGARA TABLALI  
POT WASH SINK WITH GRIDDLE PLATE**

MODEL	ÖLÇÜLER DIMENSIONS
INO-EKN 070	700x700x570
INO-EKN 080	800x800x570
INO-EKN 100	1000x800x570
INO-EKN 120	1200x800x570
INO-EKN 140	1400x1000x570

**INO-EKK**
**BULAŞIK BASMA HAVUZU / ISITMALI  
POT BOILING SINK**

MODEL	AÇIKLAMA FEATURES
INO-EKK120	1200x800x850 mm

**INO-EEN**
**EL YIKAMA EVİYESİ  
HAND WASH SINK**

MODEL	ÖLÇÜLER DIMENSIONS
INO-EED 055 (dolaplı/ with cupboard)	485x420x850
INO-EEN 055 (duvar tipi/ wall mounted)	485x420x200
INO-EEN101D	500x425x550
INO-EEN102D	500x425x550

**INO-EET**
**TEMİZLİK EVİYESİ  
MOP SINK**

MODEL	ÖLÇÜLER DIMENSIONS
INO-EET 060	500x700x900 mm

**2042003200  
2098000745**
**SİFON TAKIMI  
SIPHON SET / TAP**

MODEL	AÇIKLAMA FEATURES
2042003200	Sifon Takımı / Siphon Set
2098000745	Evye Bataryası / Tap

# SERVİS HATLARI



- Paslanmaz sacdan imal edilmiştir.
- Çift yönlü camlı nefeslik, kutu içinden led aydınlatmalı,
- 220-240V,
- R404A gazlı sistem
- Kolay temizlenebilir.
- Kir tutmaz yüzey.
- Soğutma donanımı ünite içindedir.

- R404A Gas system
- Made of Stainless steel
- Easy Clean
- 220-240V,
- Dirty-Proff surface
- With Digital Termostat control

**INO-KTS**

SERVİS TEZGAHI / SICAK DOLAPLI  
SERVICE TABLE / WITH HOT CABINET



	ÖLÇÜLER / DIMENSIONS
INO-KTS 140	1400x700x850
INO-KTS 150	1500x700x850
INO-KTS 160	1600x700x850
INO-KTS 190	1900x700x850

**INO-KTK**

KÖŞE SERVİS TEZGAHI / ARA RAFLI  
CORNER TYPE SERVICE TABLE  
WITH INTERMEDIATE SHELF



MODEL	AÇIKLAMA / DETAILS
INO-KTK 030D	Köşe servis tezgahı 30 dış / External Angle 30°
INO-KTK 030I	Köşe servis tezgahı 30 iç, ara raflı Intermediate Shelf Internal Angle 30°
INO-KTK 045D	Köşe servis tezgahı 45 dış / External Angle 30°
INO-KTK 045I	Köşe servis tezgahı 45 iç, ara raflı Intermediate Shelf Internal Angle 30°
INO-KTK 060D	Köşe servis tezgahı 60 dış / External Angle 30°
INO-KTK 060I	Köşe servis tezgahı 60 iç, ara raflı Intermediate Shelf Internal Angle 30°
INO-KTK 090D	Köşe servis tezgahı 90 dış / External Angle 30°
INO-KTK 090I	Köşe servis tezgahı 90 iç, ara raflı Intermediate Shelf Internal Angle 30°

**INO-KSN**

SICAK SERVİS ÜNİTESİ  
HOT SERVICE UNIT



MODEL	KAPASİTE CAPACITY	ÖLÇÜLER / DIMENSIONS
INO-KSN 080	2x1 / 1GN	800x700x850
INO-KSN 120	3x1 / 1GN	1200x700x850
INO-KSN 150	4x1 / 1GN	1500x700x850
INO-KSN 160	4x1 / 1GN	1600x700x850
INO-KSN 193L / 193R	3x1 / 1GN	1900x700x850
INO-KSN 194L / 194R	4x1 / 1GN	1900x700x850
INO-KSN 195	5x1 / 1GN	1900x700x850

**INO-KSS**

SICAK SERVİS ÜNİTESİ / SICAK DOLAPLI  
HOT SERVICE UNIT / WITH HOT CABINET



MODEL	KAPASİTE CAPACITY	ÖLÇÜLER / DIMENSIONS
INO-KSS 120	3x1 / 1GN	1200x700x850
INO-KSS 150	4x1 / 1GN	1500x700x850
INO-KSS 160	4x1 / 1GN	1600x700x850
INO-KSS 193L	3x1 / 1GN	1900x700x850
INO-KSS 193R	3x1 / 1GN	1900x700x850
INO-KSS 195	5x1 / 1GN	1900x700x850

**INO-KSF**

SICAK SERVİS ÜNİTESİ / STAND + RAFLI  
HOT SERVICE UNIT/ WITH STAND + SHELF



MODEL	KAPASİTE CAPACITY	ÖLÇÜLER / DIMENSIONS
INO-KSF 190	2x2 / 1GN + 1x1 / 1GN	1900x700x850
INO-KSF 240	2x2 / 1GN + 2x1 / 1GN	2400x700x850

**INO-KSP**

SICAK PLEYT ÜNİTESİ  
HOT PLATE UNIT



MODEL	ÖLÇÜLER / DIMENSIONS
INO-KSP 080	800x700x850
INO-KSP 120	1200x700x850

**INO-KBN**

SERVİS BUZDOLABI  
COLD SERVICE UNIT  
SOĞUTUCU DAHİL  
WITH COOLING CUPBOARD



MODEL	ÖLÇÜLER / DIMENSIONS
INO-KBN 140	1400x700x850
INO-KBN 190	1900x700x850



**SERVİS BUZDOLABI**  
**COLD SERVICE UNIT**

SOĞUTUCU VE GN 1/150 MM. KAP DAHİL  
COOLING AND GN CONTAINERS 1/150MM INCLUDED

### INO-KBK



MODEL	KAPASİTE CAPACITY	ÖLÇÜLER / DIMENSIONS
INO-KBK 140	3x1 / 1GN	1400x700x850
INO-KBK 190	4x1 / 1GN	1900x700x850



**SERVİS BUZDOLABI / HAVUZLU**  
**COLD SERVICE UNIT/ WITH WELL**

SOĞUTUCU DAHİL  
REFRIGERATOR INCLUDED

### INO-KBH



MODEL	ÖLÇÜLER / DIMENSIONS
INO-KBH 140	1400x700x850
INO-KBH 190	1900x700x850



**GARSON BANKOSU / DOLAPLI ARA RAFLI**  
**WAITER'S COUNTER / WITH CUPBOARD**

### INO-KGD



MODEL	ÖLÇÜLER / DIMENSIONS
INO-KGD 100	1000x400x850
INO-KGD 120	1200x400x850
INO-KGD 140	1400x400x850
INO-KGD 160	1600x400x850
INO-KGD 180	1800x400x850



**GARSON BANKOSU / ARA RAFLI**  
**WAITER'S COUNTER/ WITH INTERMEDIATE SHELF**

### INO-KGN



MODEL	ÖLÇÜLER / DIMENSIONS
INO-KGN 080	800x400x850
INO-KGN 100	1000x400x850
INO-KGN 120	1200x400x850
INO-KGN 140	1400x400x850
INO-KGN 160	1600x400x850
INO-KGN 180	1800x400x850



**GARSON BANKOSU / SICAK DOLAPLI**  
**WAITER'S COUNTER/ WITH HOT CABINET**

### INO-KGS



MODEL	ÖLÇÜLER / DIMENSIONS
INO-KGS 120	1200x400x850
INO-KGS 160	1600x400x850
INO-KGS 190	1900x400x850

**INO-KRC**
**SERVİS RAFI / ÇİFT SIRA  
SERVICE SHELF / DOUBLE**

MODEL	ÖLÇÜLER / DIMENSIONS
INO-KRC 080	800x400x650
INO-KRC 090	900x400x650
INO-KRC 100	1000x400x650
INO-KRC 110	1100x400x650
INO-KRC 120	1200x400x650
INO-KRC 130	1300x400x650
INO-KRC 140	1400x400x650
INO-KRC 150	1500x400x650
INO-KRC 160	1600x400x650
INO-KRC 170	1700x400x650
INO-KRC 180	1800x400x650
INO-KRC 190	1900x400x650

**INO-KRC**
**SERVİS RAFI / ÇİFT SIRA / ÖNÜ CAMLI  
SERVICE SHELF / DOUBLE / WITH FRONT GLASS**

MODEL	ÖLÇÜLER / DIMENSIONS
INO-KRC 080C	800x400x650
INO-KRC 100C	1000x400x650
INO-KRC 120C	1200x400x650
INO-KRC 140C	1400x400x650
INO-KRC 160C	1600x400x650
INO-KRC 190C	1900x400x650

**INO-KRN**
**SERVİS RAFI / TEK SIRA  
SERVICE SHELF / SINGLE**

MODEL	ÖLÇÜLER / DIMENSIONS
INO-KRN 080	800x400x450
INO-KRN 090	900x400x450
INO-KRN 100	1000x400x450
INO-KRN 110	1100x400x450
INO-KRN 120	1200x400x450
INO-KRN 130	1300x400x450
INO-KRN 140	1400x400x450
INO-KRN 150	1500x400x450
INO-KRN 160	1600x400x450
INO-KRN 170	1700x400x450
INO-KRN 180	1800x400x450
INO-KRN 190	1900x400x450

**INO-KRN**
**SERVİS RAFI / TEK SIRA / ÖNÜ CAMLI  
SERVICE SHELF / SINGLE / WITH FRONT GLASS**

MODEL	ÖLÇÜLER / DIMENSIONS
INO-KRN 080C	800x400x450
INO-KRN 090C	900x400x450
INO-KRN 100C	1000x400x450
INO-KRN 110C	1100x400x450
INO-KRN 120C	1200x400x450
INO-KRN 130C	1300x400x450
INO-KRN 140C	1400x400x450
INO-KRN 150C	1500x400x450
INO-KRN 160C	1600x400x450
INO-KRN 170C	1700x400x450
INO-KRN 180C	1800x400x450
INO-KRN 190C	1900x400x450



**SALAT BAR**  
**SALAT BAR**

SOĞUTUCU DAHİL, 4 TARAFLI FORMLU, GN 1/2 KÜVETLİ, AYDINLATMALI  
COOLER INCLUDED/ WITH GN 1/2 CONTAINER/ WITH LIGHTING

**INO-KCK**

MODEL	KAPASİTE CAPACITY	ÖLÇÜLER / DIMENSIONS
INO-KCK 120	6x1 / 2GN	1800x1200
INO-KCK 160	8x1 / 2GN	1800x1200

Stand standart ürüne dahildir  
Stand is included in standart product.



**INO-KRB**

**BARDAK RAFI**  
**GLASS SHELF**

MODEL	ÖLÇÜLER / DIMENSIONS
INO-KRB 061	600x600x450
INO-KRB 062	600x600x500
INO-KRB 063	600x600x650

Stand standart ürüne dahil değildir  
Stand is not included in standart product.



**SALAT BAR / HAVUZLU**  
**SALAD BAR / WITH POOL**

SOĞUTUCU DAHİL, 4 TARAFLI FORMLU, AYDINLATMALI  
COOLER INCLUDED, WITH LIGHTING

**INO-KCH**



MODEL	ÖLÇÜLER / DIMENSIONS
INO-KCH 120	1800x1300x1400
INO-KCH 160	2200x1300x1400

Stand standart ürüne dahildir  
Stand is included in standart product.



**INO-KVB**

**VİTRİN SOĞUTMALI**  
**DISPLAY UNIT**

SOĞUTUCU DAHİL, BUZDOLAPLI  
COOLER INCLUDED, WITH REFRIGERATOR



MODEL	ÖLÇÜLER / DIMENSIONS
INO-KVB 140	1400x700x1600
INO-KVB 190	1900x700x1600

Stand standart ürüne dahil değildir  
Stand is not included in standart product.



**SALAT BAR RAFI**  
**SERVICE SHELF WITH LIGHTING**

SERVİS RAFI AYDINLATMALI  
SERVICE SHELF WITH LIGHTING

**INO-KRS**

MODEL	ÖLÇÜLER / DIMENSIONS
INO-KRS 120	1200x700x550
INO-KRS 160	1600x700x550



**INO-KKN**

**KÜVER ÜNİTESİ  
CUTLERY UNIT**



MODEL	ÖLÇÜLER / DIMENSIONS
INO-KKN 073	700x700x1300
INO-KKN 076	700x700x1300



**INO-KKR**

**KÜVER ÜNİTESİ  
CUTLERY UNIT**



MODEL	ÖLÇÜLER / DIMENSIONS
INO-KKR 063	600x400x450
INO-KKR 066	700x700x1300
INO-KKR 084	800x400x450



**INO-KKF**

**KÜVER ÜNİTESİ/  
BFT'Lİ TEPŞİ STANDI / KÜVER RAFLI  
CUTLERY UNIT / WITH BFT  
TRAY SLIDER / GN SHELF**



MODEL	ÖLÇÜLER / DIMENSIONS
INO-KKF 060	600x700x1300



**INO-KTN**

**SERVİS TEZGAHI  
ARA RAFLI  
SERVICE TABLE  
WITH INTERMEDIATE SHELF**



MODEL	ÖLÇÜLER / DIMENSIONS
INO-KTN 040	400x700x850
INO-KTN 050	500x700x850
INO-KTN 060	600x700x850
INO-KTN 070	700x700x850
INO-KTN 080	800x700x850
INO-KTN 090	900x800x850
INO-KTN 100	1000x700x850

**INO-KVB**

TEŞHİR BUZDOLABI, ÖNÜ AÇIK, 3 RAFLI  
OPEN FRONT DISPLAY REFRIGERATOR, 3 SHELVES

MODEL	ÖLÇÜLER DIMENSIONS	RAF SHELF
INO-KVB120A	1200x700x1600	3
INO-KVB150A	1800x700x1600	3
INO-KVB180A	1500x700x1600	3

**INO-KVB**

TEŞHİR BUZDOLABI, GECE PERDELİ, 3 RAFLI  
DISPLAY REFRIGERATOR, NIGHT CURTAIN, 3 SHELVES

MODEL	ÖLÇÜLER DIMENSIONS	RAF SHELF
INO-KVB120P	1200x700x1600	3
INO-KVB150P	1500x700x1600	3
INO-KVB180P	1800x700x1600	3

**INO-KRG**

SERVİS RAFI / GARSON TİPİ / TEKLİ  
SERVICE SHELF / WAITER TYPE / SINGLE

MODEL	ÖLÇÜLER / DIMENSIONS
INO-KRG 080	800x400x450
INO-KRG 090	900x400x450
INO-KRG 100	1000x400x450
INO-KRG 110	1100x400x450
INO-KRG 120	1200x400x450
INO-KRG 130	1300x400x450
INO-KRG 140	1400x400x450
INO-KRG 150	1500x400x450
INO-KRG 160	1600x400x450
INO-KRG 170	1700x400x450
INO-KRG 180	1800x400x450
INO-KRG 190	1900x400x450
INO-KRG 200	2000x400x450
INO-KRG 210	2100x400x450
INO-KRG 220	2200x400x450
INO-KRG 230	2300x400x450
INO-KRG 240	2400x400x450

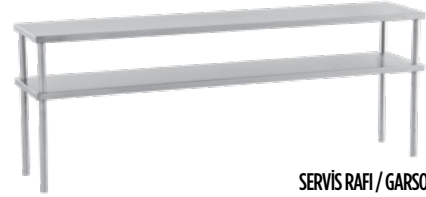
**INO-KRG**

SERVİS RAFI / GARSON TİPİ / İKİ SIRA  
SERVICE SHELF / WAITER TYPE / DOUBLE

MODEL	ÖLÇÜLER / DIMENSIONS
INO-KRG 082	800x400x700
INO-KRG 092	900x400x700
INO-KRG 102	1000x400x700
INO-KRG 112	1100x400x700
INO-KRG 122	1200x400x700
INO-KRG 132	1300x400x700
INO-KRG 142	1400x400x700
INO-KRG 152	1500x400x700
INO-KRG 162	1600x400x700
INO-KRG 172	1700x400x700
INO-KRG 182	1800x400x700
INO-KRG 192	1900x400x700
INO-KRG 202	2000x400x700
INO-KRG 212	2100x400x700
INO-KRG 222	2200x400x700
INO-KRG 232	2300x400x700
INO-KRG 242	2400x400x700

**INO-KLN**
**TEPSİ STANDI / CR-Nİ BORU  
TRAY SLIDE / CR-NI PIPE**
**SERVİS RAFI AYDINLATMASI  
LIGHTING FOR SERVICE SHELF**

MODEL	ÖLÇÜLER / DIMENSIONS
INO-KLN 050	500x320x32
INO-KLN 060	600x320x32
INO-KLN 070	700x320x32
INO-KLN 080	800x320x32
INO-KLN 090	900x320x32
INO-KLN 100	1000x320x32
INO-KLN 110	1100x320x32
INO-KLN 120	1200x320x32
INO-KLN 130	1300x320x32
INO-KLN 140	1400x320x32
INO-KLN 150	1500x320x32
INO-KLN 160	1600x320x32
INO-KLN 170	1700x320x32
INO-KLN 180	1800x320x32
INO-KLN 190	1900x320x32
INO-KLN 200	2000x320x32
INO-KLN 210	2100x320x32
INO-KLN 220	2200x320x32
INO-KLN 230	2300x320x32
INO-KLN 240	2400x320x32

MODEL	ÖLÇÜLER / DIMENSIONS
2040427010	700 mm
2040427011	800 mm
2040427020	900 mm
2040427021	1000 mm
2040427030	1100 mm
2040427031	1200 mm
2040427040	1300 mm
2040427041	1400 mm
2040427050	1500 mm
2040427051	1600 mm
2040427060	1700 mm
2040427061	1800 mm
2040427070	1900 mm
2040427071	2000 mm
2040427080	2100 mm
2040427081	2200 mm
2040427090	2300 mm
2040427091	2400 mm
2040427100	2500 mm

**INO-KLN**
**TEPSİ STANDI / CR-Nİ BORU  
TRAY SLIDE / CORNER TYPE**

Halojen Lambalı / Halogen lighting

MODEL	ÖLÇÜLER / DIMENSIONS
2040427200	800 mm
2040427210	1200 mm
2040427220	1600 mm
2040427230	1900 mm

MODEL	AÇILAR / ANGLE
INO-KLN K30	30°
INO-KLN K40	45°
INO-KLN K60	60°
INO-KLN K90	90°

**INO-KLG**
**GRANİT TEPSİ STANDI PROFİLİ  
GRANITE TRAY SLIDER PROFILE**

MODEL	ÖLÇÜLER / DIMENSIONS
INO-KLG 050	500x300x60 mm
INO-KLG 060	600x300x60 mm
INO-KLG 070	700x300x60 mm
INO-KLG 080	800x300x60 mm
INO-KLG 090	900x300x60 mm
INO-KLG 100	1000x300x60 mm
INO-KLG 110	1100x300x60 mm
INO-KLG 120	1200x300x60 mm
INO-KLG 130	1300x300x60 mm
INO-KLG 140	1400x300x60 mm
INO-KLG 150	1500x300x60 mm
INO-KLG 160	1600x300x60 mm
INO-KLG 170	1700x300x60 mm
INO-KLG 180	1800x300x60 mm
INO-KLG 190	1900x300x60 mm
INO-KLG 200	2000x300x60 mm
INO-KLG 210	2100x300x60 mm
INO-KLG 220	2200x300x60 mm
INO-KLG 230	2300x300x60 mm
INO-KLG 240	2400x300x60 mm
INO-KLG K30	30 ° Köşe / Corner
INO-KLG K45	45 ° Köşe / Corner
INO-KLG K60	60 ° Köşe / Corner
INO-KLG K90	90 ° Köşe / Corner

**BAZALAR  
KICK PLATES**

MODEL	AÇIKLAMA / DESCRIPTION
2040200889	Yan / Side
2040200860	400mm
2040200861	500mm
2040200862	600mm
2040200863	700mm
2040200864	800mm
2040200865	900mm
2040200866	1000mm
2040200867	1100mm
2040200868	1200mm
2040200869	1300mm
2040200870	1400mm
2040200871	1500mm
2040200874	1800mm
2040200875	1900mm

MODEL	AÇIKLAMA / DESCRIPTION
2040200876	2000mm
2040200877	2100mm
2040200878	2200mm
2040200879	2300mm
2040200880	2400mm
2040200881	30° dış / external
2040200882	30° iç / internal
2040200883	45° dış / external
2040200884	45° iç / internal
2040200885	60° dış / external
2040200886	60° iç / internal
2040200887	90° dış / external
2040200888	90° iç / internal

# DROP-IN SERVİS ÜNİTELERİ

DROP-IN SERVICE UNITS



- Paslanmaz sacdan imal edilmiştir.
- Çift yönlü camlı nefeslik, kutu içinden led aydınlatmalı,
- 220-240V,
- R404A gazlı sistem
- Kolay temizlenebilir.
- Kir tutmaz yüzey.
- Soğutma donanımı ünite içindedir.

- R404A Gas system
- Sneeze guard with double sided glass, led illumination from wooden box
- Made of Stainless steel
- Easy Clean
- 220-240V,
- Dirty-Proff surface
- With Digital Termostat control

**INO-KDC 3 / 4 / 5**

DROP-IN SOĞUK  
HAVUZ FANLI  
DROP IN COLD WELL WITH FAN



MODEL	EBATLAR / DIMENSIONS	ELEKTRİK GÜCÜ / ELECTRIC POWER
	cm	kW
KDC3	1200x700	0,75
KDC4	1500x700	0,75
KDC5	1800x700	0,85

GN kütvetler ile uyumlu değildir.

**INO-KDV 3 / 4 / 5**

DROP-IN  
SOĞUK VİTRİN  
DROP IN COLD DISPLAY



MODEL	EBATLAR / DIMENSIONS	ELEKTRİK GÜCÜ / ELECTRIC POWER
	cm	kW
KDV3	1235x700	0,85
KDV4	1535x700	0,85
KDV5	1835x700	1

**INO-KDF 3 / 4 / 5**

DROP-IN SOĞUK  
PASLANMAZ YÜZEY  
DROP IN COLD SURFACE, FLAT

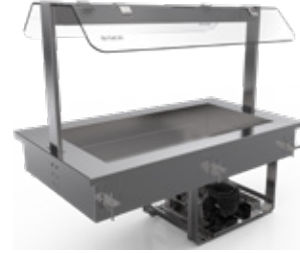

MODEL	EBATLAR / DIMENSIONS	ELEKTRİK GÜCÜ / ELECTRIC POWER
	cm	kW
KDF3	1200x700	0,75
KDF4	1500x700	0,75
KDF5	1800x700	0,85

**INO-KDSB 3 / 4 / 5**

DROP-IN STATİK  
SOĞUK HAVUZ  
DROP IN SALAD BAR



MODEL	EBATLAR / DIMENSIONS	ELEKTRİK GÜCÜ / ELECTRIC POWER	GN 1/1
	cm	kW	(adet)
KDSB3	1200x700	0,75	3
KDSB4	1500x700	0,75	4
KDSB5	1800x700	0,85	5



**INO-KDHD 3 / 4 / 5**

**DROP-IN BENMARİ  
SICAK FANLI  
DROP IN BAIN MARIE, HOT AIR**



MODEL	EBATLAR / DIMENSIONS	ELEKTRİK GÜCÜ / ELECTRIC POWER	GN 1/1
	cm	kW	(adet)
KDHD3	1200x700	2,1	3
KDHD4	1500x700	2,1	4
KDHD5	1800x700	3,3	5

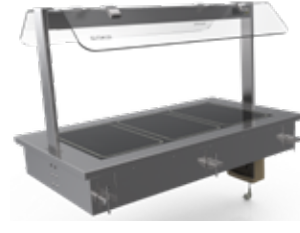

**INO-KDHS 3 / 4 / 5**

**DROP IN TEMPERLİ  
CAM YÜZEY ISITMA  
DROP IN TEMPERED  
GLASS SURFACE HEATING**



MODEL	EBATLAR / DIMENSIONS	ELEKTRİK GÜCÜ / ELECTRIC POWER	GN 1/1
	cm	kW	(adet)
KDHS3	1200x700	3	3
KDHS4	1500x700	4	4
KDHS5	1800x700	5	5



**INO-KDH 3 / 4 / 5**

**DROP-IN  
BENMARİ SULU  
DROP IN HOT BAIN MARIE**



MODEL	EBATLAR / DIMENSIONS	ELEKTRİK GÜCÜ / ELECTRIC POWER	GN 1/1
	cm	kW	(adet)
KDH3	1200x700	3	3
KDH4	1500x700	4	4
KDH5	1800x700	5	5



Fiyatlar 1 metre içindir. Baza hariçtir.  
Prices for 1 mt. Kick plate not included the price.



**2040709330**
**LAMİNAT KAPLAMA  
LAMINATE COVER**

RUBY-A

2040709330

Ceviz / Walnut

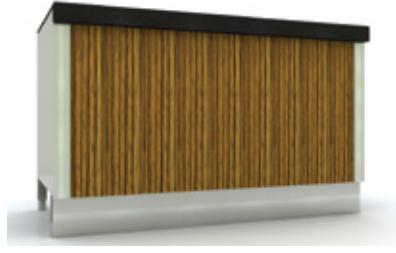
Paslanmaz Sac / S/S Sheet

**2040709331**
**LAMİNAT KAPLAMA  
LAMINATE COVER**

RUBY-B

2040709331

Zeytin / Olive

Paslanmaz Sac / S/S Sheet



**2040709332**
**LAMİNAT KAPLAMA  
LAMINATE COVER**

RUBY-C

2040709332

Akçaağaç / Maple

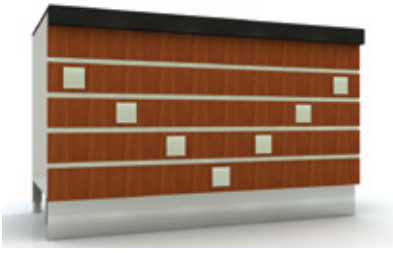
Wenge / Wenge

**2040709333**
**LAMİNAT KAPLAMA  
LAMINATE COVER**

SAFİR-A

2040709333

Armut / Pear

Metal Laminat / Metal Laminate

Alüminyum Çıta / Aluminium Strips

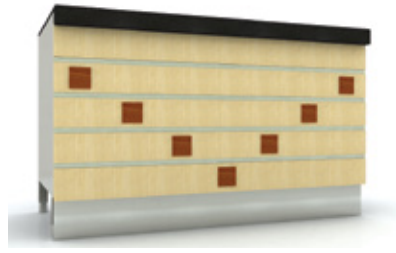

**2040709334**
**LAMİNAT KAPLAMA  
LAMINATE COVER**

SAFİR-B

2040709334

Akçaağaç / Maple

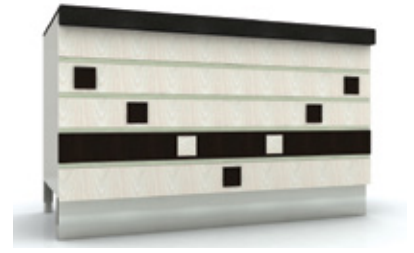
Armut / Pear

**2040709335**
**LAMİNAT KAPLAMA  
LAMINATE COVER**

SAFİR-C

2040709335

Hus / Silver Birch

Wenge / Wenge

Alüminyum Çıta / Aluminium Strips

**2040709312**
**LAMİNAT KAPLAMA  
LAMINATE COVER**

KUARTZ-A

2040709312

Akçaağaç / Maple

Kiraz / Cherry

**2040709313**
**LAMİNAT KAPLAMA  
LAMINATE COVER**

KUARTZ-B

2040709313

Pelesenk / Rosewood

Alüminyum Çıta / Aluminium Strips

**2040709314**
**LAMİNAT KAPLAMA  
LAMINATE COVER**

KUARTZ-C

2040709314

Akçaağaç / Maple

Pelesenk / Rosewood

Alüminyum Çıta / Aluminium Strips

**AHŞAP PANELLER/  
WOODEN PANELS**

Fiyatlar 1 metre içindir. Baza hariçtir. - Prices for 1 mt. Kick plate not included the price.

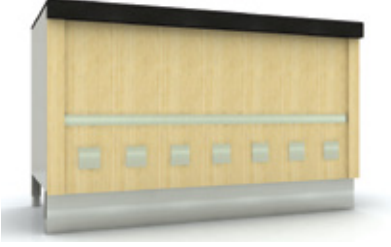

**2040709327**

LAMİNAT KAPLAMA  
LAMINATE COVER

OPAL-A

2040709327

Akçaağaç / Maple

Metal Laminat / Metal Laminate



**2040709328**

LAMİNAT KAPLAMA  
LAMINATE COVER

OPAL-B

2040709328

Kiraz / Cherry

Metal Laminat / Metal Laminate



**2040709329**

LAMİNAT KAPLAMA  
LAMINATE COVER

OPAL-C

2040709329

Wenge / Wenge

Akçaağaç / Maple



**2040709309**

LAMİNAT KAPLAMA  
LAMINATE COVER

FLORIT-A

2040709309

Abanoz / Ebony

Metal Laminat / Metal Laminate



**2040709310**

LAMİNAT KAPLAMA  
LAMINATE COVER

FLORIT-B

2040709310

Maun / Mahogany

Metal Laminat / Metal Laminate

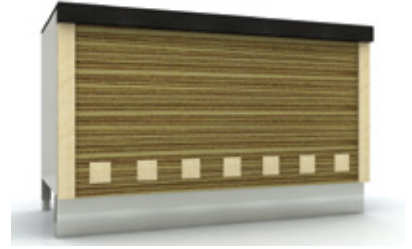

**2040709311**

LAMİNAT KAPLAMA  
LAMINATE COVER

FLORIT-C

2040709311

Zebrano / Zebrano

Akçaağaç / Maple

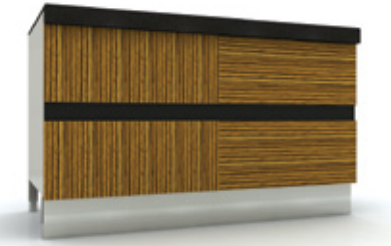

**2040709315**

LAMİNAT KAPLAMA  
LAMINATE COVER

LABRADORIT-A

2040709315

Zeytin / Olive

Siyah / Black

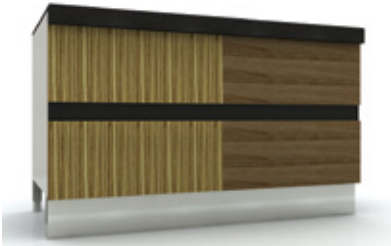

**2040709316**

LAMİNAT KAPLAMA  
LAMINATE COVER

LABRADORIT-B

2040709316

Zebrano / Zebrano

Ceviz / Walnut

Siyah / Black



**2040709317**

LAMİNAT KAPLAMA  
LAMINATE COVER

LABRADORIT-C

2040709317

Meşe / Oak

Siyah / Black

**2040709303**
**LAMİNAT KAPLAMA  
LAMINATE COVER**

AVENTURIN-B

**2040709303**

Akçaağaç / Maple

Teak / Chestnut

With black colour strip

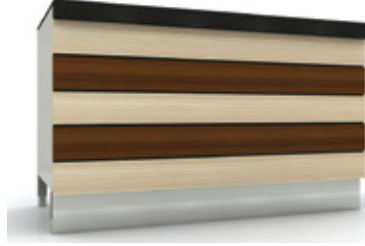
**2040709304**
**LAMİNAT KAPLAMA  
LAMINATE COVER**

AVENTURIN-A

**2040709304**

Mese / Oak

Ceviz / Walnut

With black colour strip

**2040709305**
**LAMİNAT KAPLAMA  
LAMINATE COVER**

AVENTURIN-C

**2040709305**

Kiraz / Cherry

Akçaağaç / Maple

With black colour strip

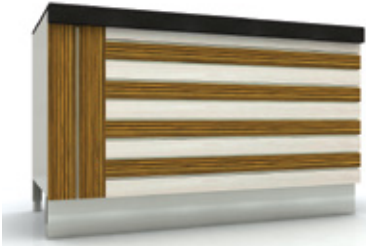
**2040709339**
**LAMİNAT KAPLAMA  
LAMINATE COVER**

ZIRCON-A

**2040709339**

Zeytin / Olive

Huş / Silver Birch

With gray colour strip

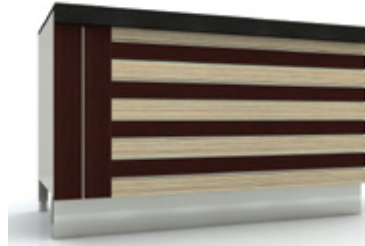
**2040709340**
**LAMİNAT KAPLAMA  
LAMINATE COVER**

ZIRCON-B

**2040709340**

Maun / Mahogany

Mese / Oak

With gray colour strip

**2040709341**
**LAMİNAT KAPLAMA  
LAMINATE COVER**

ZIRCON-C

**2040709341**

Kayın / East Beech

Ceviz / Walnut

With gray colour strip

**2040709336**
**LAMİNAT KAPLAMA  
LAMINATE COVER**

TURKUAZ-A

**2040709336**

Akçaağaç / Maple

Kiraz / Cherry

Alüminyum çita / Aluminium strips

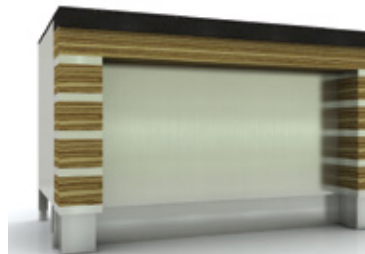
**2040709337**
**LAMİNAT KAPLAMA  
LAMINATE COVER**

TURKUAZ-B

**2040709337**

Zebrano / Zebrano

Alüminyum Çita / Aluminium strips

**2040709338**
**LAMİNAT KAPLAMA  
LAMINATE COVER**

TURKUAZ-C

**2040709338**

Teak / Teak

Akçaağaç / Maple

Alüminyum Çita / Aluminium strips

**AHŞAP PANELLER/  
WOODEN PANELS**

Fiyatlar 1 metre içindir. Baza hariçtir. - Prices for 1 mt. Kick plate not included the price.



**2040709306**

LAMİNAT KAPLAMA  
LAMINATE COVER

EMERALD-A

2040709306

Mese / Oak

Paslanmaz Sac / S/S Sheet



**2040709307**

LAMİNAT KAPLAMA  
LAMINATE COVER

EMERALD-B

2040709307

Maun / Mahogany

Akçaağaç / Maple



**2040709308**

LAMİNAT KAPLAMA  
LAMINATE COVER

EMERALD-C

2040709308

Pelesenk / Rosewood

Paslanmaz Sac / S/S Sheet

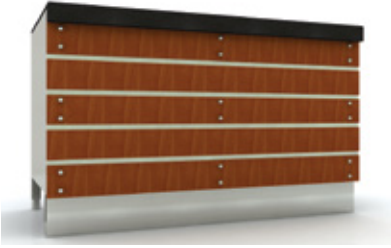

**2040709300**

LAMİNAT KAPLAMA  
LAMINATE COVER

AMETIS-A

2040709300

Armut / Pear

Alüminyum Çita / Aluminium strips

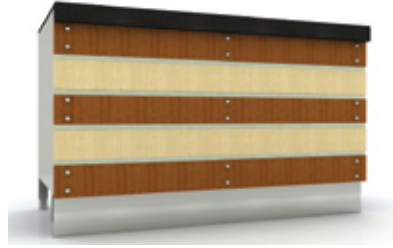

**2040709301**

LAMİNAT KAPLAMA  
LAMINATE COVER

AMETIS-B

2040709301

Ceviz / Walnut

Akçaağaç / Maple

Alüminyum Çita / Aluminium strips

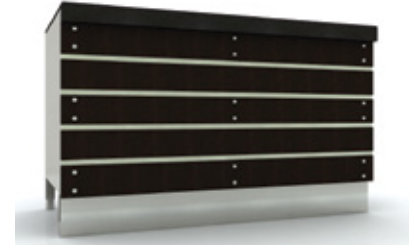

**2040709302**

LAMİNAT KAPLAMA  
LAMINATE COVER

AMETIS-C

2040709302

Wenge / Wenge

Alüminyum Çita / Aluminium strips

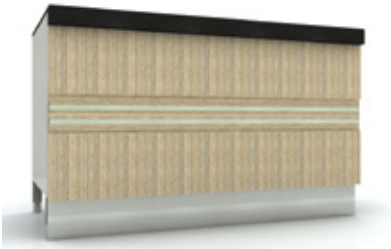

**2040709318**

LAMİNAT KAPLAMA  
LAMINATE COVER

LAL-A

2040709318

Mese / Oak

Alüminyum Çita / Aluminium strips

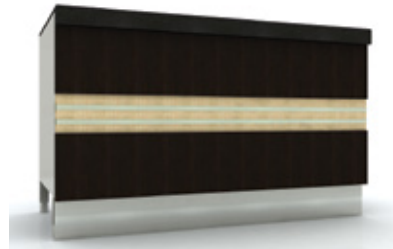

**2040709319**

LAMİNAT KAPLAMA  
LAMINATE COVER

LAL-B

2040709319

Wenge / Wenge

Mese / Oak

Alüminyum Çita / Aluminium strips



**2040709320**

LAMİNAT KAPLAMA  
LAMINATE COVER

LAL-C

2040709320

Ceviz / Walnut

Wenge / Wenge

Alüminyum Çita / Aluminium strips

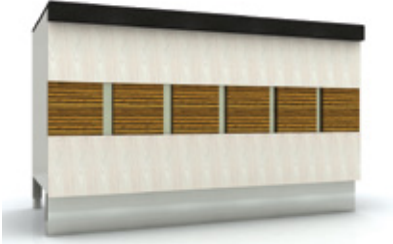

**2040709321**

LAMİNAT KAPLAMA  
LAMINATE COVER

LAPIS-A

2040709321

Huş / Silver Birch

Zeytin / Olive



**2040709322**

LAMİNAT KAPLAMA  
LAMINATE COVER

LAPIS-B

2040709322

Wenge / Wenge

Akcağaç / Wenge

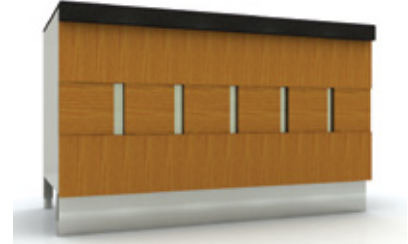

**2040709323**

LAMİNAT KAPLAMA  
LAMINATE COVER

LAPIS-C

2040709323

Kayın / Beech



**2040709324**

LAMİNAT KAPLAMA  
LAMINATE COVER

ONIKS-A

2040709324

Kiraz / Cherry

With black colour strip

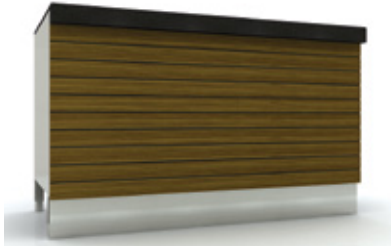

**2040709325**

LAMİNAT KAPLAMA  
LAMINATE COVER

ONIKS-B

2040709325

Teak / Chestnut

With black colour strip



**2040709326**

LAMİNAT KAPLAMA  
LAMINATE COVER

ONIKS-C

2040709326

Huş / Silver Birch

With black colour strip



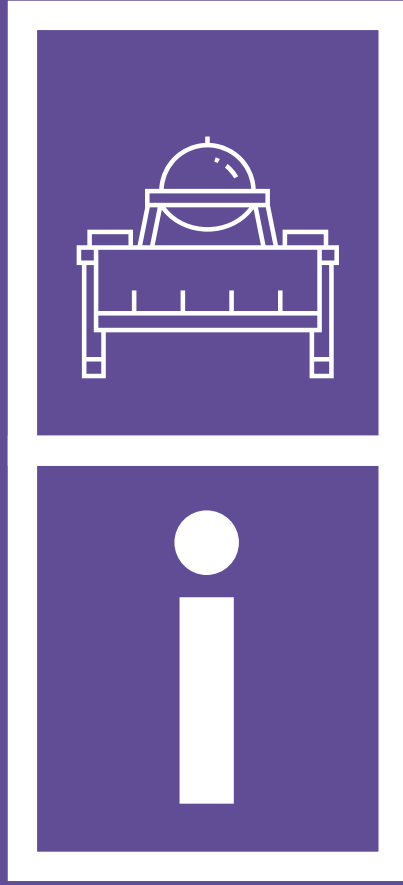

## **İnoksdesign Açık Büfe ve Servis Hatları**

Inoksdesign Open Buffets  
And Service Lines



# INOKSDESIGN AÇIK BÜFE VE SERVİS HATLARI

.....  
INOKSDESIGN OPEN BUFFETS  
AND SERVICE LINES



- Ünitelerin taşıyıcı karkaslarında kutu profil kullanılmaktadır. Ana karkas elektrostatik toz boya ile kaplanmaktadır.
- Üst tablada Absolute Black granit kullanılmıştır. Üst tabla altında bulunan alın ve alt gövde MDFLAM kaplamalıdır.
- İsteğe göre laminat kaplama, doğal ahşap kaplama, lake boya vs. da kullanılabilir. Soğuk ve sıcak ünitelerde standart olarak floresan aydınlatmalı çift camlı nefeslik bulunmaktadır.
- Soğuk ve sıcak servis ünitelerinde standart boy ve genişlikleri çizelgelerde verilmiştir.
- İsteğe bağlı olarak farklı boy ve genişliklerde üretim yapılabilir.
- Chafing dish'li sıcak ünitelerde elektrikli ithal ürünler kullanılmıştır.
- Chafing dish'lerin altından yere su damlamasını engellemek için tava bulunmaktadır.

- Box type profile is used on support frame on the units. Main frame is made of electrostatic powder painted steel profile.
- Worktop is Absolute Black granite. Fascia under working surface and lower frame is laminate covered on MDFLAM.
- Natural wooden veneer, laminate veneer, lacquer paint, etc. can be used optionally. There is double glass shelf with fluorescent lighting on hot and cold service units as standard.
- Standard dimensions of cold and hot service units are indicated on the catalogue. They can be manufactured in different dimensions optionally.
- Electric IMPORTED PRODUCTSs are used in hot units with chafing dish.
- There is a tray to prevent dripping of water from chafing dishes to floor.



**INO-OSA-BL**

**EKMEK SERVİS ÜNİTESİ  
BREAD SERVICE UNIT**

Polyetilen Kesme Tablolu, Kırıntı Havuzu, Ahşap EkmeK Rafı, Mobil Ünite  
With cutting board / Crumb well / Wooden bread shelf / Mobile

MODEL	EBATLAR / DIMENSIONS
	mm
INO-OSA-BL 100	1140x1000x900
INO-OSA-BL 160	1740x1000x900
INO-OSA-BL 200	2140x1000x900



**INO-OSA-CL G**

**SOĞUK SERVİS ÜNİTESİ  
GRANİT YÜZEY SOĞUTMALI  
COLD SERVICE UNIT  
WITH GRANITE COOLING TOP**

Cam Nefeslikli, LED Floresan Aydınlatmalı, Mobil Ünite  
With Sneeze guards glass / LED fluorescent lighting / mobile

MODEL	GÜÇ POWER	EBATLAR DIMENSIONS
	kW	mm
INO-OSA-CL 160G	0.75	1740x1000x900 - 1450
INO-OSA-CL 200G	0.85	2140x1000x900 - 1450



**INO-OSA-HL**

**SICAK SERVİS ÜNİTESİ / BENMARI  
HOT SERVICE UNIT / WITH GN CONTAINERS**

GN kütvetler fiyata dahil değildir.  
GN containers are not included the price.

Cam Nefeslikli, LED Floresan Aydınlatmalı, Mobil Ünite  
With Sneeze guards glass / LED fluorescent lighting / mobile

MODEL	GÜÇ POWER	EBATLAR DIMENSIONS
	kW	mm
INO-OSA-HL 133	2.25	1440x1000x900 - 1450 3 GN kap. / cap.
INO-OSA-HL 164	3	1740x1000x900 - 1450 4 GN kap. / cap.
INO-OSA-HL 205	4	2140x1000x900 - 1450 5 GN kap. / cap.

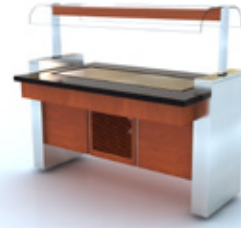

**INO-OSA-CL**

**SOĞUK SERVİS ÜNİTESİ  
PASLANMAZ YÜZEY SOĞUTMALI  
COLD SERVICE UNIT  
WITH S/S COOLING TOP**

Cam Nefeslikli, LED Floresan Aydınlatmalı, Mobil Ünite  
With S/S Cooling Top / LED fluorescent lighting / mobile



MODEL	GÜÇ POWER	EBATLAR DIMENSIONS
	kW	mm
INO-OSA-CL 160P	0.75	1740x1000x900 - 1450
INO-OSA-CL 200P	0.85	2140x1000x900 - 1450



**INO-OSA-CL H**

**SOĞUK SERVİS ÜNİTESİ  
STATİK SOĞUTMA HAVUZU  
COLD SERVICE UNIT  
WITH STATIC COOLING POOL**

GN kütvetler fiyata dahil değildir.  
GN containers are not included the price.

Cam Nefeslikli, LED Floresan Aydınlatmalı, Mobil Ünite  
With Sneeze guards glass / LED fluorescent lighting / mobile



MODEL	GÜÇ POWER	EBATLAR DIMENSIONS
	kW	mm
INO-OSA-CL 164H	0.75	1740x1000x900 - 1450 4 GN kap. / cap.
INO-OSA-CL 205H	0.85	2140x1000x900 - 1450 5 GN kap. / cap.



**INO-OSA-HLC**

**SICAK SERVİS ÜNİTESİ / CAM ISITMA YÜZEYİ  
HOT SERVICE UNIT / GLASS HEATING SURFACE**

GN kütvetler fiyata dahil değildir.  
GN containers are not included the price.

Cam Nefeslikli, LED Floresan Aydınlatmalı, Mobil Ünite  
With Sneeze guards glass / LED fluorescent lighting / mobile

MODEL	GÜÇ POWER	EBATLAR DIMENSIONS
	kW	mm
OSA-HLC133	3,25	"144x100x90/145 3 GN kap. / cap."
OSA-HLC164	4,25	"174x100x90/145 4 GN kap. / cap."
OSA-HLC205	5,25	"214x100x90/145 5 GN kap. / cap."





**INO-OSA-HLI**

**SICAK SERVİS ÜNİTESİ / CAM ISITMA YÜZEYİ**  
**HOT SERVICE UNIT / GLASS HEATING SURFACE**

İndüksiyon uyumlu chaffing dish.

LED Floresan Aydınlatmalı, Mobil Ünite  
LED fluorescent lighting / mobile



MODEL	GÜÇ POWER	EBATLAR DIMENSIONS
	kW	mm
OSA-HLI162	2	"174x100x90/145 2 adet / pieces"
OSA-HLI203	3	"214x100x90/145 3 adet / pieces"



**INO-OSA-CL**

**SOĞUK SERVİS ÜNİTESİ**  
**PASLANMAZ YÜZEY SOĞUTMALI**  
**COLD SERVICE UNIT**  
**WITH S/S COOLING TOP**

Cam Nefeslikli, LED Floresan Aydınlatmalı, Mobil Ünite  
With Sneeze guards glass / LED fluorescent lighting / mobile



MODEL	GÜÇ POWER	EBATLAR DIMENSIONS
	kW	mm
INO-OSA-CL 160P	0.75	1740x1000x900 - 1450
INO-OSA-CL 200P	0.85	2140x1000x900 - 1450



**INO-OSA-CL H**

**SOĞUK SERVİS ÜNİTESİ**  
**SOĞUTMA HAVUZU**  
**COLD SERVICE UNIT**  
**WITH COOLING POOL**

GN küvetler fiyata dahil değildir.  
GN containers are not included the price.

Cam Nefeslikli, LED Floresan Aydınlatmalı, Mobil Ünite  
With Sneeze guards glass / LED fluorescent lighting / mobile



MODEL	GÜÇ POWER	EBATLAR DIMENSIONS
	kW	mm
INO-OSA-CL 164H	0.75	1740x1000x900 - 1450 4 GN kap. / cap.
INO-OSA-CL 205H	0.85	2140x1000x900 - 1450 5 GN kap. / cap.

\*Ürün görsellerinde farklılıklar gözlemlenebilmektedir, lütfen satış temsilcinizden bilgi alınız.  
\*Product images may change slightly, please contact with your sales representative.



**INO-OSA-PL 100**

**NÖTR TABAK ÜNİTESİ**  
**NEUTRAL PLATE UNIT**

Granit Tabak Havuzu, Mobil Ünite  
With granite plate pool / mobile



MODEL	EBATLAR / DIMENSIONS
	mm
INO-OSA-PL 100	1140x1000x900



**INO-OSA-DL**

**SICAK SERVİS ÜNİTESİ**  
**CHAFFING DISH**  
**HOT SERVICE UNIT**  
**WITH CHAFFING DISHES**

Cam Nefeslikli, LED Floresan Aydınlatmalı, Mobil Ünite  
With Sneeze guards glass / LED fluorescent lighting / mobile



MODEL	GÜÇ POWER	EBATLAR DIMENSIONS
	kW	mm
INO-OSA-DL 162	1.5	1740x1000x900 - 1450 2 ADET GN 1/1
INO-OSA-DL 233	2.25	2440x1000x900 - 1450 3 GN 1/1 Chaffingdish



**INO-OSA-SL 162E**

**ÇORBA SERVİS ÜNİTESİ**  
**SOUP SERVICE UNIT**

2 Adet 9 lt. Çorbalık, Mobil Ünite  
With 2 pcs soup kettle(9lt.) / mobile



MODEL	GÜÇ POWER	EBATLAR DIMENSIONS
	kW	mm
INO-OSA-SL 162E	2.5	1740x1000x900



**INO-OSA-NL**

**NÖTR SERVİS ÜNİTESİ  
NEUTRAL SERVICE UNIT**

Mobil Ünite  
Mobile



MODEL	EBATLAR / DIMENSIONS
	mm
INO-OSA-NL 100	1140x1000x900
INO-OSA-NL 160	1740x1000x900
INO-OSA-NL 200	2140x1000x900



**INO-OSA-DL 164**

**SICAK SERVİS ÜNİTESİ  
CHAFFING DISH  
HOT SERVICE UNIT  
WITH CHAFFING DISHES**

Mobil Ünite  
Mobile



MODEL	GÜÇ POWER	EBATLAR DIMENSIONS
	kW	mm
INO-OSA-DL 164	3	1740x1300x900 4 ADET GN 1/1 CHAFFINGDISH



**INO-OSA-SL K**

**ÇORBA SERVİS ÜNİTESİ  
SOUP SERVICE UNIT**

1 Adet 7 lt. Küresel Chaffing Dish Çorbalık, Mobil Ünite  
2 Adet 7 lt. Küresel Chaffing Dish Çorbalık, Mobil Ünite  
With 1 pc. Rolltop soup chaffing dish / mobile With 2 pcs. Rolltop soup chaffing dish / mobile

MODEL	GÜÇ POWER	EBATLAR DIMENSIONS
	kW	mm
INO-OSA-SL 161K	1.8	1740x1000x900
INO-OSA-SL 202K	2.3	2140x1000x900





**INO-OSA-SL G**

**ÇORBA SERVİS ÜNİTESİ  
SOUP SERVICE UNIT**

2 adet GN1/1 corbalk chafingdish 4,5+4,5 lt kapasiteli  
with 2 pcs. 1/1 GN chafingdish for soup 4,5+4,5 lt capacity



MODEL	GÜÇ POWER	EBATLAR DIMENSIONS
	kW	mm
INO-OSA-SL 161G	2	1740x1000x900
INO-OSA-SL 202G	2.7	2140x1000x900



**INO-OSA-WL 230**

**MEYVE KESİM ÜNİTESİ  
FRUIT SERVICE UNIT**

2 adet 2/1 GN Soğuk Havuz, 1 Adet 530 x 320 Kesim Tahtası, Mobil Ünite  
With 2 pcs. 2/1 GN coling pool / 1 pc. cutting board 530x320cm / mobile



MODEL	GÜÇ POWER	EBATLAR DIMENSIONS
	kW	mm
INO-OSA-WL 230	0.85	2440x1000x900



**INO-OSA-WL 202**

**SHOW SERVİS ÜNİTESİ  
SHOW UNIT**

1 ADET GN 1/1 CHAFINGDISH  
WITH 1 PCS. GN 1/1 CHAFINGDISH



MODEL	GÜÇ POWER	EBATLAR DIMENSIONS
	kW	mm
INO-OSA-WL 202	1	2140x1000x900

Cihazlar fiyata dahil değildir.  
Devices are not included the price.



**INO-OSA-WL 160**

**SHOW SERVİS ÜNİTESİ  
SHOW UNIT**

GN KAPLAR FIYATA DAHİL DEĞİLDİR

1 ADET GN 1/1 CHAFINGDISH  
WITH 1 PCS. GN 1/1 CHAFINGDISH



MODEL	GÜÇ POWER	EBATLAR DIMENSIONS
	kW	mm
INO-OSA-WL 160	1	1740x1000x900

Cihazlar fiyata dahil değildir.  
Devices are not included the price.



**INO-OSA-WL 200**

**SHOW SERVİS ÜNİTESİ  
SHOW UNIT**

1 ADET GN 1/1 CHAFINGDISH  
WITH 1 PCS. GN 1/1 CHAFINGDISH



MODEL	GÜÇ POWER	EBATLAR DIMENSIONS
	kW	mm
INO-OSA-WL 200	1	2140x1000x900

Cihazlar fiyata dahil değildir. - Devices are not included the price.





**INO-OSF-BL**

**EKMEK SERVİS ÜNİTESİ**  
**BREAD SERVICE UNIT**

Poliyeten Kesme Tablolu, Kırıntı Havuzu, Ahşap Ekmek Rafı, Mobil Ünite  
With cutting board / crumb well / wooden bread shelf / mobile

MODEL	EBATLAR / DIMENSIONS
	mm
INO-OSF-BL 100	1000x1000x900
INO-OSF-BL 160	1600x1000x900
INO-OSF-BL 200	2000x1000x900



**INO-OSF-CL G**

**SOĞUK SERVİS ÜNİTESİ**  
**GRANİT YÜZEY SOĞUTMALI**  
**COLD SERVICE UNIT**  
**WITH GRANITE COOLING TOP**

Cam Nefeslikli, LED Floresan Aydınlatmalı, Mobil Ünite  
With Sneeze guards glass / LED Fluorescent Lighting / mobile

MODEL	GÜÇ POWER	EBATLAR DIMENSIONS
	kW	mm
INO-OSF-CL 160G	0.75	1600x1000x900 - 1450
INO-OSF-CL 200G	0.85	2000x1000x900 - 1450



**INO-OSF-HL**

**SICAK SERVİS ÜNİTESİ / BENMARI**  
**HOT SERVICE UNIT / WITH GN CONTAINERS**

GN küvetler fiyata dahil değildir.  
GN containers are not included the price.

Cam Nefeslikli, LED Floresan Aydınlatmalı, Mobil Ünite  
With Sneeze guards glass / LED Fluorescent Lighting / mobile

MODEL	GÜÇ POWER	EBATLAR DIMENSIONS
	kW	mm
INO-OSF-HL 133	2,25	1300x1000x900 - 1450 3 GN kap. / cap.
INO-OSF-HL 164	3	1600x1000x900 - 1450 4 GN kap. / cap.
INO-OSF-HL 205	4	2000x1000x900 - 1450 5 GN kap. / cap.



**INO-OSF-CL P**

**SOĞUK SERVİS ÜNİTESİ**  
**PASLANMAZ YÜZEY SOĞUTMALI**  
**COLD SERVICE UNIT**  
**WITH S/S COOLING TOP**

Cam Nefeslikli, LED Floresan Aydınlatmalı, Mobil Ünite  
With Sneeze guards glass / With S/S cooling top / LED Fluorescent Lighting / mobile

MODEL	GÜÇ POWER	EBATLAR DIMENSIONS
	kW	mm
INO-OSF-CL 160P	0.75	1600x1000x900 - 1450
INO-OSF-CL 200P	0.85	2000x1000x900 - 1450



**INO-OSF-CL H**

**SOĞUK SERVİS ÜNİTESİ**  
**STATİK SOĞUTMA HAVUZU**  
**COLD SERVICE UNIT**  
**WITH STATIC COOLING POOL**

GN küvetler fiyata dahil değildir.  
GN containers are not included the price.

Cam Nefeslikli, LED Floresan Aydınlatmalı, Mobil Ünite  
With Sneeze guards glass / LED Fluorescent Lighting / mobile

MODEL	GÜÇ POWER	EBATLAR DIMENSIONS
	kW	mm
INO-OSF-CL 164H	0.75	1600x1000x900 - 1450 4 GN kap. / cap.
INO-OSF-CL 205H	0.85	2000x1000x900 - 1450 5 GN kap. / cap.



**INO-OSF-HLC**

**SICAK SERVİS ÜNİTESİ / CAM ISITMA YÜZEYLİ**  
**HOT SERVICE UNIT / GLASS HEATING SURFACE**

GN küvetler fiyata dahil değildir.  
GN containers are not included the price.

Cam Nefeslikli, LED Floresan Aydınlatmalı, Mobil Ünite  
With Sneeze guards glass / LED Fluorescent Lighting / mobile

MODEL	GÜÇ POWER	EBATLAR DIMENSIONS
	kW	mm
OSF-HLC133	3,25	"130x100x90/145 3 GN kap. / cap."
OSF-HLC164	4,25	"160x100x90/145 4 GN kap. / cap."
OSF-HLC205	5,25	"200x100x90/145 5 GN kap. / cap."





**INO-OSF-HLI**

**SICAK SERVİS ÜNİTESİ / CAM ISITMA YÜZEYLİ  
HOT SERVICE UNIT / GLASS HEATING SURFACE**

İndüksiyon uyumlu chafing dish.

LED Floresan Aydınlatmalı, Mobil Ünite  
LED Flourescent Lighting / mobile

MODEL	GÜÇ POWER	EBATLAR DIMENSIONS
	kW	mm
OSF-HLI162	2	"160x100x90/145 2 adet / pieces"
OSF-HLI203	3	"200x100x90/145 3 adet / pieces"



**INO-OSF-DL**

**SICAK SERVİS ÜNİTESİ  
CHAFING DISH  
HOT SERVICE UNIT  
WITH CHAFFING DISHES**

Cam Nefesli, LED Floresan Aydınlatmalı, Mobil Ünite  
With Sneeze guards glass / LED Flourescent Lighting / mobile

MODEL	GÜÇ POWER	EBATLAR DIMENSIONS
	kW	mm
INO-OSF-DL 162	1.5	1600x1000x900 - 1450 2 ADET GN 1/1
INO-OSF-DL 233	2.25	2300x1000x900 - 1450 3 adet GN 1/1 Chafingdish



**INO-OSF-PL 070**

**ISITMALI YAYLI TABAK ÜNİTESİ  
HEATED PLATE UNIT**

50 Adet Tabak Kapasitesi, Mobil Ünite , 2 Adet Tabak Kartusu  
50 plates capacity / mobile

MODEL	GÜÇ POWER	EBATLAR DIMENSIONS
	kW	mm
INO-OSF-PL 070	1	700X1000X900



**INO-OSF-SL 162E**

**ÇORBA SERVİS ÜNİTESİ  
SOUP SERVICE UNIT**

2 Adet 9 lt. Çorbalk, Mobil Ünite  
With 2 pcs soup kettle(9lt) / mobile

MODEL	GÜÇ POWER	EBATLAR DIMENSIONS
	kW	mm
INO-OSF-SL 162E	2.5	1600x1000x900



**INO-OSF-PL 100**

**NÖTR TABAK ÜNİTESİ  
NEUTRAL PLATE UNIT**

Granit Tabak Havuzu, Mobil Ünite  
With granite plate pool / Mobile

MODEL	EBATLAR / DIMENSIONS
	mm
INO-OSF-PL 100	1000x1000x900



**INO-OSF-NL**

**NÖTR SERVİS ÜNİTESİ  
NEUTRAL SERVICE UNIT**

Mobil Ünite  
Mobile

MODEL	EBATLAR / DIMENSIONS
	mm
INO-OSF-NL 100	1000x1000x900
INO-OSF-NL 160	1600x1000x900
INO-OSF-NL 200	2000x1000x900





**INO-OSF-DL 164**

**SICAK SERVİS ÜNİTESİ**  
CHAFING DISH  
**HOT SERVICE UNIT**  
WITH CHAFFING DISHES

Mobil Ünite  
Mobile

MODEL	GÜÇ POWER	EBATLAR DIMENSIONS
	kW	mm
INO-OSF-DL 164	3	1600x1300x900 4 ADET GN 1/1



**INO-OSF-SL K**

**ÇORBA SERVİS ÜNİTESİ**  
SOUP SERVICE UNIT

1 Adet 7 lt. Küresel Chafing Dish Çorbalık, Mobil Ünite  
2 Adet 7 lt. Küresel Chafing Dish Çorbalık, Mobil Ünite  
With 1 pc. Rolltop soup chafing dish / mobile\* With 2 pcs. Rolltop soup chafing dish / mobile

MODEL	GÜÇ POWER	EBATLAR DIMENSIONS
	kW	mm
INO-OSF-SL 161K	2	1600x1000x900
INO-OSF-SL 202K	2.3	2000x1000x900



**INO-OSF-SL G**

**ÇORBA SERVİS ÜNİTESİ**  
SOUP SERVICE UNIT

2 adet GN/1 çorbalık chafingdish 2\*(4,5+4,5 lt) kapasiteli  
with 2 pcs. 1/1 GN chafingdish for soup 4,5+4,5 lt capacity

MODEL	GÜÇ POWER	EBATLAR DIMENSIONS
	kW	mm
INO-OSF-SL 161G	2	1600x1000x900
INO-OSF-SL 202G	2.5	2000x1000x900



**INO-OSF-WL 230**

**MEYVE KESİM ÜNİTESİ**  
FRUIT SERVICE UNIT

2 Adet 2/1 GN Soğuk Havuz, 1 Adet 530 x 320 Kesim Tahtası, Mobil Ünite  
With 2 pcs. 2/1 GN cooling pool / 1 pc. cutting board (53x32cm) / mobile

MODEL	GÜÇ POWER	EBATLAR DIMENSIONS
	kW	mm
INO-OSF-WL 230	0.85	2300x1000x900



SHOW SERVİS ÜNİTESİ  
SHOW UNIT

## INO-OSF-WL 202

MODEL	GÜÇ POWER	EBATLAR DIMENSIONS
	kw	mm
INO-OSF-WL 202	1	2000x1000x900 GN 1/1 CHAFINGDISH



Cihazlar fiyata dahil değildir.  
Devices are not included the price.

SHOW SERVİS ÜNİTESİ  
SHOW UNIT

## INO-OSF-WL 160

MODEL	GÜÇ POWER	EBATLAR DIMENSIONS
	kw	mm
INO-OSF-WL 160	1	1600x1000x900 GN 1/1 CHAFINGDISH



Cihazlar fiyata dahil değildir. - Devices are not included the price.



## INO-OSF-WL 200

SHOW SERVİS ÜNİTESİ

MODEL	GÜÇ POWER	EBATLAR DIMENSIONS
	kw	mm
INO-OSF-WL 200	1	2000x1000x900 GN 1/1 CHAFINGDISH



Cihazlar fiyata dahil değildir.  
Devices are not included the price.





**INO-0GE-BL**

**EKMEK SERVİS ÜNİTESİ  
BREAD SERVICE UNIT**

Poliyetilen kesme tablası, kırınıt havuzlu, ahşap ekme rafı, mobil ünite  
With cutting board / crumb well / wooden bread shelf / mobile

MODEL	EBATLAR / DIMENSIONS
	mm
INO-0GE-BL 100	1000x1000x900
INO-0GE-BL 160	1600x1000x900
INO-0GE-BL 200	2000x1000x900

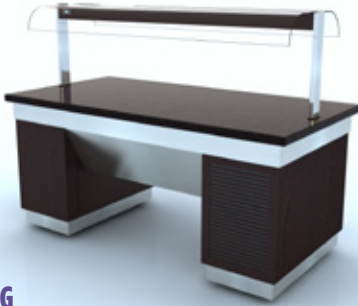

**INO-0GE-CL G**

**SOĞUK SERVİS ÜNİTESİ  
GRANİT YÜZEY SOĞUTMALI  
COLD SERVICE UNIT  
WITH GRANITE COOLING TOP**

Cam Nefeslikli, LED Floresan Aydınlatmalı, Mobil Ünite  
With Sneeze guards glass / LED Fluorescent Lighting / mobile

MODEL	GÜÇ POWER	EBATLAR DIMENSIONS
	kW	mm
INO-0GE-CL 160G	0.75	1600x1000x900 - 1450
INO-0GE-CL 200G	0.85	2000x1000x900 - 1450



**INO-0GE-HL**

**SICAK SERVİS ÜNİTESİ / BENMARI  
HOT SERVICE UNIT / WITH GN CONTAINERS**

GN küvetler fiyata dahil değildir.  
GN containers are not included the price.

Cam Nefeslikli, LED Floresan Aydınlatmalı, Mobil Ünite  
With Sneeze guards glass / LED Fluorescent Lighting / mobile

MODEL	GÜÇ POWER	EBATLAR DIMENSIONS
	kW	mm
INO-0GE-HL 133	2.25	1300x1000x900 - 1450 3 GN kap./cap.
INO-0GE-HL 164	3	1600x1000x900 - 1450 4 GN kap./cap.
INO-0GE-HL 205	4	2000x1000x900 - 1450 5 GN kap./cap.



**INO-0GE-CL**

**SOĞUK SERVİS ÜNİTESİ  
PASLANMAZ YÜZEY SOĞUTMALI  
COLD SERVICE UNIT  
WITH S/S COOLING TOP**

Cam Nefeslikli, LED Floresan Aydınlatmalı, Mobil Ünite  
With Sneeze guards glass / LED Fluorescent Lighting / mobile

MODEL	GÜÇ kW	EBATLAR mm
INO-0GE-CL 160P	0.75	1600x1000x900 - 1450
INO-0GE-CL 200P	0.85	2000x1000x900 - 1450



**INO-0GE-CL H**

**SOĞUK SERVİS ÜNİTESİ  
STATİK SOĞUTMA HAVUZU  
COLD SERVICE UNIT  
WITH STATIC COOLING POOL**

GN KAPLAR FIYATA DAHİL DEĞİLDİR  
Cam Nefeslikli, LED Floresan Aydınlatmalı, Mobil Ünite  
With Sneeze guards glass / LED Fluorescent Lighting / mobile

vMODEL	GÜÇ POWER	EBATLAR DIMENSIONS
	kW	mm
INO-0GE-CL 164H	0.75	1600x1000x900 - 1450 4 GN kap. / cap.
INO-0GE-CL 205H	0.85	2000x1000x900 - 1450 5 GN kap. / cap.



**INO-0GE-HLC**

**SICAK SERVİS ÜNİTESİ / CAM ISITMA YÜZEYLİ  
HOT SERVICE UNIT / GLASS HEATING SURFACE**

GN küvetler fiyata dahil değildir.  
GN containers are not included the price.

Cam Nefeslikli, LED Floresan Aydınlatmalı, Mobil Ünite  
With Sneeze guards glass / LED Fluorescent Lighting / mobile

MODEL	GÜÇ POWER	EBATLAR DIMENSIONS
	kW	mm
0GE-HLC133	3,25	"130x100x90/145 - 3 GN kap. / cap."
0GE-HLC164	4,25	"160x100x90/145 - 4 GN kap. / cap."
0GE-HLC205	5,25	"200x100x90/145 - 5 GN kap. / cap."





**INO-OGE-HLI**

**SICAK SERVİS ÜNİTESİ / İNDÜKSİYON ISITICI**  
**HOT SERVICE UNIT / INDUCTION HEATER**

İndüksiyon uyumlu chafing dishler dahil değildir

Mobil Ünite  
Mobile

MODEL	GÜÇ POWER	EBATLAR DIMENSIONS
	kw	mm
OGE-HLI162	2	"160x100x90/145 2 adet / pieces"
OGE-HLI203	3	"200x100x90/145 3 adet / pieces"



**INO-OGE-PL 100**

**NÖTR TABAK ÜNİTESİ**  
**NEUTRAL PLATE UNIT**

Granit Tabak Havuzu, Mobil Ünite  
With granite plate pool / mobile

MODEL	EBATLAR / DIMENSIONS
	mm
INO-OGE-PL 100	1000x1000x900



**INO-OGE-DL**

**SICAK SERVİS ÜNİTESİ**  
**CHAFING DISH**  
**HOT SERVICE UNIT**  
**WITH CHAFFING DISHES**

Cam Nefeslikli, LED Floresan Aydınlatmalı, Mobil Ünite  
With Sneeze guards glass / LED Fluorescent Lighting / mobile

MODEL	GÜÇ POWER	EBATLAR DIMENSIONS
	kw	mm
INO-OGE-DL 162	1.5	1600x1000x900 - 1450 2 ADET GN 1/1 CHAFINGDISH kap./cap.
INO-OGE-DL 233	2.25	2300x1000x900 - 1450 3 adet GN 1/1 Chafingdish kap./cap.



**INO-OGE-PL 070**

**ISITMALI YAYLI TABAK ÜNİTESİ**  
**HEATED PLATE UNIT**

İndüksiyon uyumlu chafing dishler dahil değildir

50x2 Adet Tabak Kapasiteli, Mobil Ünite  
50 plates capacity / mobile

MODEL	GÜÇ POWER	EBATLAR DIMENSIONS
	kw	mm
INO-OGE-PL 070	1	700x1000x900



**INO-OGE-NL**

**NÖTR SERVİS ÜNİTESİ**  
**NEUTRAL SERVICE UNIT**

Mobil Ünite

MODEL	EBATLAR / DIMENSIONS
	mm
INO-OGE-NL 100	1000x1000x900
INO-OGE-NL 160	1600x1000x900
INO-OGE-NL 200	2000x1000x900



**INO-OGE-DL 164**

**SICAK SERVİS ÜNİTESİ**  
**CHAFING DISH**  
**HOT SERVICE UNIT**  
**WITH CHAFFING DISHES**

Mobil Ünite / 4 ADET GN 1/1 CHAFINGDISH kap.  
MOBILE UNIT / WITH 4 PCS. GN 1/1 CHAFINGDISH cap.

MODEL	GÜÇ POWER	EBATLAR DIMENSIONS
	kw	mm
INO-OGE-DL 164	3	1600x1300x900





**INO-OGESL 162E**

**ÇORBA SERVİS ÜNİTESİ  
SOUP SERVICE UNIT**

2 Adet 9 lt. Çorbalk, Mobil Ünite  
With 2 pcs soup kettle(9lt.) / mobile

MODEL	GÜÇ POWER	EBATLAR DIMENSIONS
	kW	mm
INO-OGESL 162E	2.5	1600x1000x900



**INO-OGESL K**

**ÇORBA SERVİS ÜNİTESİ  
SOUP SERVICE UNIT**

1 Adet 7 lt. Küresel Chafing Dish Çorbalk, Mobil Ünite  
2 Adet 7 lt. Küresel Chafing Dish Çorbalk, Mobil Ünite  
With 1 pc. Rolltop soup chafing dish / mobile  
With 2 pcs. Rolltop soup chafing dish / mobile

MODEL	GÜÇ POWER	EBATLAR DIMENSIONS
	kW	mm
INO-OGESL 161K	2	1600x1000x900
INO-OGESL 202K	2.7	2000x1000x900



**INO-OGESL G**

**ÇORBA SERVİS ÜNİTESİ  
SOUP SERVICE UNIT**

2 adet GN1/1 çorbalk chafindish 2\*(4,5+4,5 lt) kapasiteli  
with 2 pcs. 1/1 GN chafingdish for soup 4,5+4,5 lt capacity

MODEL	GÜÇ POWER	EBATLAR DIMENSIONS
	kW	mm
INO-OGESL 161G	2	1600x1000x900
INO-OGESL 202G	2.7	2000x1000x900

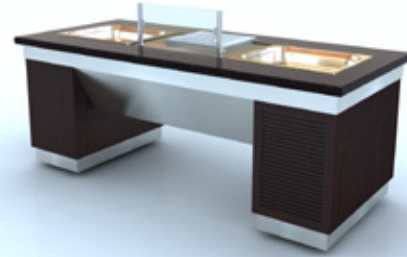

**INO-OGEWL 230**

**MEYVE KESİM ÜNİTESİ  
FRUIT SERVICE UNIT**

2 Adet 2/1 GN Soğuk Havuz, 1 Adet 530 x 320 Kesim Tahtası, Mobil Ünite  
With 2 pcs. 2/1 GN coling pool / 1 pc. cutting board 530x320cm / mobile

MODEL	GÜÇ POWER	EBATLAR DIMENSIONS
	kW	mm
INO-OGEWL 230	0.85	2300x1000x900



**INO-OGEWL 202**

**SHOW SERVİS ÜNİTESİ  
SHOW UNIT**

MODEL	GÜÇ POWER	EBATLAR DIMENSIONS
	kW	mm
INO-OGEWL 202	1	2000x1000x900 1 ADET GN 1/1 CHAFINGDISH



**INO-OGEWL 160**

**SHOW SERVİS ÜNİTESİ  
SHOW UNIT**

MODEL	GÜÇ POWER	EBATLAR DIMENSIONS
	kW	mm
INO-OGEWL 160	1	1600x1000x900 1 ADET GN 1/1 CHAFINGDISH



Cihazlar fiyata dahil değildir.  
Devices are not included the price.

\*Ürün görsellerinde farklılıklar gözlemlenebilmektedir, lütfen satış temsilcinizden bilgi alın.  
\*Product images may change slightly, please contact with your sales representative.



**INO-OGE-WL 200**

SHOW SERVİS ÜNİTESİ  
SHOW UNIT

MODEL	GÜÇ POWER	EBATLAR DIMENSIONS
	kW	mm
INO-OGE-WL 200	1	2000x1000x900 1 ADET GN 1/1 CHAFINGDISH



Cihazlar fiyata dahil değildir.  
Devices are not included the price.



**INO-OCN160P**

SALAT BAR  
SALAD BAR

Düz cam, Nefesliki, LED Floresan Aydınlatmalı, Mobil Ünite GN Kaplar fiyata dahil değildir.  
Flat glass / LED Flourescent Lighting / mobile / GN Containers are not included

MODEL	GÜÇ / POWER	EBATLAR / DIMENSIONS
	kW	mm
INO-OCN160P	0,75	1530x900



**INO-OCN160PS**

SALAT BAR  
SALAD BAR

Düz cam, Nefesliki, LED Floresan Aydınlatmalı, Mobil Ünite GN Kaplar fiyata dahil değildir.  
Flat glass / LED Flourescent Lighting / mobile / GN Containers are not included

MODEL	GÜÇ / POWER	EBATLAR / DIMENSIONS
	kW	mm
INO-OCN160PS	0,75	1530x900



**INO-ABT125S**

**BOŞ TOPLAMA ARABASI  
TRAY COLLECTION TROLLEY**

5mm wenge rengi kompakt laminat kaplama. Sıyrma huni  
5mm plywood laminate wenge colour, with scrapping hole

MODEL	EBATLAR / DIMENSIONS
	mm
INO-ABT125S	1530x900



**INO-ABT105C**

**BOŞ TOPLAMA ARABASI  
TRAY COLLECTION TROLLEY**

5mm wenge rengi kompakt laminat kaplama. Devrilir çekmeceli  
5mm plywood laminate wenge colour, with titling drawer

MODEL	EBATLAR / DIMENSIONS
	mm
INO-ABT105C	1530x900



**INO-OSS-CL160P80**

**SOĞUK SERVİS ÜNİTESİ  
COLD SERVICE UNIT**

Granit cinsi 20mm Rosa Porino, Dekor 18mm MDFLAM,  
Alüminyum Çıtalı, Paslanmaz Yüzey soğutmali  
Stainless steel cooling surface, 20mm Rosa Porino granite, 18mm MDFLAM decor

MODEL	GÜÇ / POWER	EBATLAR / DIMENSIONS
	kW	mm
INO-OSS-CL160P80	0,75	1600 x 800 x 900-1450

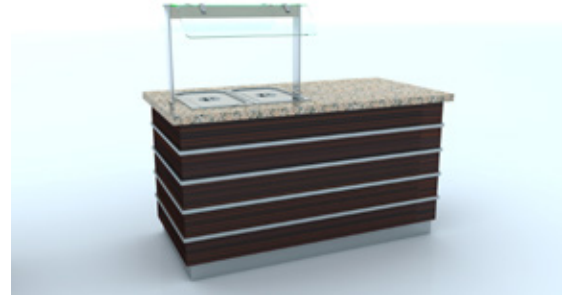

**INO-OSS-HL16280**

**2 GN SICAK BAINMARIE, NÖTR BÜFE  
HOT/ COLD SERVICE UNIT**

Granit cinsi 20mm Rosa Porino, Dekor 18mm MDFLAM, Alüminyum çıtalı  
20mm RosaPorino granite, 18mm MDFLAM decor

MODEL	EBATLAR / DIMENSIONS
	mm
INO-OSS-HL16280	1600 x 800 x 900-1450





**INO-OSS-NL16080**

**NÖTR SERVİS ÜNİTESİ  
NEUTRAL SERVICE UNIT**

Granit cinsi 20mm Rosa Porino, Dekor 18mm MDFLAM, Alüminyum çtali  
20mm RosaPorino granite, 18mm MDFLAM decor

MODEL	EBATLAR / DIMENSIONS	PG EAC
	mm	
INO-OSS-NL16080	1600 x 800 x 900	



**INO-OST-CL160P80**

**SOĞUK SERVİS ÜNİTESİ  
COLD SERVICE UNIT**

Granit cinsi 20mm Rosa Porino, Dekor 18mm MDFLAM. Paslanmaz yüzey soğutmalı  
Stainless steel cooling surface, 20mm RosaPorino granite, 18mm MDFLAM decor

MODEL	GÜÇ / POWER	EBATLAR / DIMENSIONS
	kW	mm
INO-OST-CL160P80	0,75	1600 x 800 x 900-1450



**INO-OST-HL16280**

**SICAK VE NÖTR SERVİS ÜNİTESİ  
HOT/ COLD SERVICE UNIT**

Granit cinsi 20mm Rosa Porino, Dekor 18mm MDFLAM, Alüminyum çtali  
20mm RosaPorino granite, 18mm MDFLAM decor

MODEL	GÜÇ / POWER	EBATLAR / DIMENSIONS
	kW	mm
INO-OST-HL16280	0,75	1600 x 800 x 900-1450



**INO-OST-NL16080**

**NÖTR SERVİS ÜNİTESİ  
NEUTRAL SERVICE UNIT**

Granit cinsi 20mm Rosa Porino, Dekor 18mm MDFLAM, Alüminyum çtali  
20mm RosaPorino granite, 18mm MDFLAM decor

MODEL	EBATLAR / DIMENSIONS	PG EAC
	mm	
INO-OST-NL16080	1600 x 800 x 900	







H



Hazırlama  
Makineleri

Preparation  
Units



# SEBZE VE HAMUR HAZIRLAMA MAKİNELERİ

VEGETABLES AND  
DOUGH  
PREPARATION  
UNITS



- Kafeterya, snack bar ve çabuk servis yapan restoranlar için idealdir.
- Üniteler tamamıyla 18/8 Cr/Ni saçtan imal edilmiş olup komple set olarak kullanılabilir şekilde dizayn edilmiştir.

- All devices and equipment are manufactured from AISI304 grade 18/8 Cr/Ni stainless steel and has been specially designed to be used as a complete set.
- Ideal for cafes, snack bars and quick service restaurants.

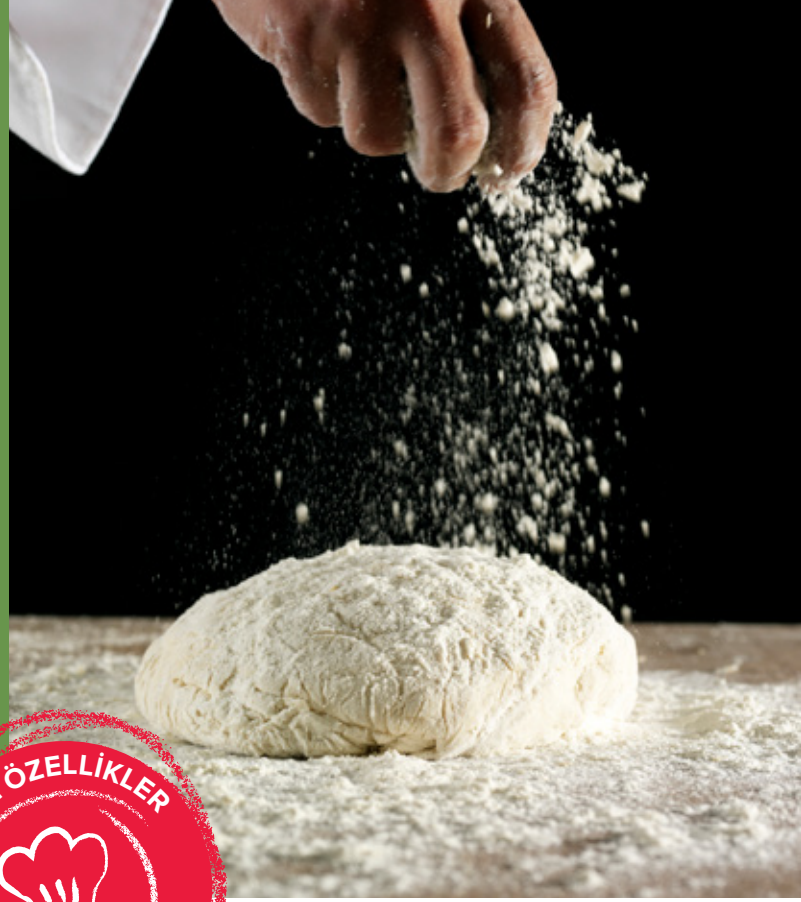



**PATATES SOYMA MAKİNESİ / ELEKTRONİK**  
**POTATO PEELING MACHINE / ELECTRICAL**



MODEL	EBATLAR	DOLDURMA KAPASİTESİ	SOYMA KAPASİTESİ	FİLTRE	MOTOR GÜCÜ	ELEKTRİK G.	SU GİRİŞİ	NET AĞ.
	DIMENSIONS	FILLING CAPACITY	PEELING CAPACITY		M. POWER	ELECTRIC INLET	WATER INLET	N.WEIGHT
INT-BH0061	420x740x870	10	200 kg/saat	Filtresiz	0,55 kW / 0,75 hp	220V – 50Hz		40
INT-BH0062	420x740x870	10	200 kg/saat	Filtresiz	0,55 kW / 0,75 hp	380V – 50Hz		40
INT-BH0063	460x740x1000	10	200 kg/saat	Filtreli	0,55 kW / 0,75 hp	220V – 50Hz		47
INT-BH0064	460x740x1000	10	200 kg/saat	Filtreli	0,55 kW / 0,75 hp	380V – 50Hz		47
INT-BH0065	520x830x960	25	500 kg/saat	Filtresiz	1,1 kW / 1,5 hp	220V – 50Hz		62
INT-BH0066	520x830x960	25	500 kg/saat	Filtresiz	1,1 kW / 1,5 hp	380V – 50Hz		62
INT-BH0067	570x830x1090	25	500 kg/saat	Filtreli	1,1 kW / 1,5 hp	220V – 50Hz		70
INT-BH0068	570x830x1090	25	500 kg/saat	Filtreli	1,1 kW / 1,5 hp	380V – 50Hz		70
INT-BH0069	520x830x1090	35	700 kg/saat	Filtresiz	1,5 kW / 2 hp	380V – 50Hz		68
INT-BH0070	570x830x1320	35	700 kg/saat	Filtreli	1,5 kW / 2 hp	380V – 50Hz		75
INT-BH0071	630x840x990	50	1000 kg/saat	Filtresiz	1,5 kW / 2 hp	380V – 50Hz		114
INT-BH0072	670x840x1150	50	1000 kg/saat	Filtreli	1,5 kW / 2 hp	380V – 50Hz		125



**INT-KR0008**

**SEBZE YIKAMA MAKİNESİ / ELEKTRONİK**  
**VEGETABLE WASHER / ELECTRICAL**



MODEL	EBATLAR	YIK. KAP.	KUR. KAP.	YIK. SÜ.	KUR. SÜ.	YIKAMA TANK KAP.	POMPA GÜCÜ	KURUTMA MOTOR G.	ELEKTRİK GİRİŞİ	SU GİRİŞİ	NET AĞ.
	DIMENSIONS	WASHING	DRYING CAP.	WASHING PERIOD	DRYING PERIOD	WASHING TANK CAP.	PUMP POWER	DRYING MOTOR P.	ELECTRIC INLET	WATER INLET	N.WEIGHT
	mm	Kg	Kg	dk/ min	dk/ min	lt	kW	kW	V	Inch	Kg
INT-KR0008	1200x600x850	4-20	2-10	4-10	2-4	70	1,50	0,37	380-400V 3N AC 50-60HZ	3/4"	136

**INT-DR0038**
**HAMUR YOĞURMA MAKİNESİ**  
**DOUGH KNEADING MACHINE**

**INT-DR0044**
**HAMUR YOĞURMA MAKİNESİ**  
**DOUGH KNEADING MACHINE**

TEKERLEKLİ / WITH WHEEL

**INT-DR0025**
**HAMUR YOĞURMA MAKİNESİ**  
**DOUGH KNEADING MACHINE**

**INT-DR0036**
**HAMUR YOĞURMA MAKİNESİ**  
**DOUGH KNEADING MACHINE**

TEKERLEKLİ / WITH WHEEL

MODEL	EBATLAR	UN KAP.	İLAVE MİK.	HAMUR MİK.	ET MİK.	KAZAN HACMİ	KAZAN Ç.	MOTOR	NET AĞ.
	DIMENSIONS	FLOUR CAP.	ADDITIONAL AMOUNT	DOUGH AMOUNT	MEAT AMOUNT	BOWL VOLUME	BOWL DIAMETER	MOTOR POWER	N.WEIGHT
	cm	Kg	Kg	Kg	Kg	lt	cm	kW	Kg
INT-DR0038	45x90x65	1-14	1-8	3-22	3-25	35	43	0,55 0,6-0,9	130
INT-DR0044	65x105x105	3-30	1,8-1,8	5-45	5-50	75	60	1,5 1,5-2,5	270
INT-DR0025	75x120x130	5-50	2-20	7-70	10-80	100	70	2,2-3,3	270
INT-DR0036	100x150x140	15-150	9-90	24-240	30-250	350	95	7,5-10	600
INT-DR0029	30x55x60	1-4	1-2	2-6	2-8	10	26	0,37 0,3-0,4	50
INT-DR0030	30x55x60	1-4	1-2	2-6	2-8	10	26	0,37 0,3-0,4	50
INT-DR0033	40x75x85	1-10	1-5	3-15	3-20	25	36	0,55 0,6-0,9	100
INT-DR0035	40x75x85	1-10	1-5	3-15	3-20	25	36	0,55 0,6-0,9	100
INT-DR0034	40x75x85	1-10	1-5	3-15	3-20	25	36	0,55 0,6-0,9	100
INT-DR0040	45x90x65	1-14	1-8	3-22	3-25	35	43	0,55 0,6-0,9	130
INT-DR0039	45x90x65	1-14	1-8	3-22	3-25	35	43	0,55 0,6-0,9	130
INT-DR0041	55x90x95	1,5-18	1-10	3-28	3-32	50	50	0,75 0,75-1,1	150
INT-DR0043	55x90x95	1,5-18	1-10	3-28	3-32	50	50	0,75 0,75-1,1	150
INT-DR0042	55x90x95	1,5-18	1-10	3-28	3-32	50	50	0,75 0,75-1,1	150
INT-DR0045	65x105x105	3-30	1,8-1,8	5-45	5-50	75	60	1,5 1,5-2,5	270
INT-DR0026	75x120x130	5-50	2-20	7-70	10-80	100	70	2,2-3,3	270
INT-DR0031	90x140x135	10-100	6-60	16-160	20-200	250	85	5,5-7,5	475
INT-DR0032	90x140x135	10-100	6-60	16-160	20-200	250	85	5,5-7,5	475
INT-DR0037	100x150x140	15-150	9-90	24-240	30-250	350	95	7,5-10	600

**INT-DR0007**

 PLANET MİKSER  
 PLANETARY MIXER

**INT-DR0009**

 PLANET MİKSER  
 PLANETARY MIXER

**INT-DR0012**

 PLANET MİKSER  
 PLANETARY MIXER

MODEL	ÜRÜN EBATLARI	KAPASİTE	HAZNE ÇAPI	GÜÇ	ELEKTRİK	N.AĞIRLIK
	PRODUCT DIMENSIONS	CAPACITY	BOWL DIAMETER	POWER	ELECTRIC	N.WEIGHT
	cm	Lt	mm	kw	V	Kg
INT-DR0007	45x60x80	10	260	0,55	220V,Değişken hız (Variable Speeds)	70
INT-DR0009	75x55x140	20	320	0,5-0,7-0,9	380V,3 hızlı (Speeds)	120
INT-DR0012	71x77x140	30	360	0,5-0,7-0,9	380V,3 hızlı (Speeds)	200

**INT-DR0014**

 PLANET MİKSER  
 PLANETARY MIXER

**INT-DR0018**

 PLANET MİKSER  
 PLANETARY MIXER

**INT-DR0023**

 PLANET MİKSER  
 PLANETARY MIXER

MODEL	ÜRÜN EBATLARI	KAPASİTE	HAZNE ÇAPI	GÜÇ	ELEKTRİK	N.AĞIRLIK
	PRODUCT DIMENSIONS	CAPACITY	BOWL DIAMETER	POWER	ELECTRIC	N.WEIGHT
	cm	Lt	mm	kw	V	Kg
INT-DR0014	70x85x150	40	400	1-1,5-1,85	380V,3 hızlı (Speeds)	245
INT-DR0018	70x85x150	60	430	1-1,5-1,85	380V,3 hızlı (Speeds)	250
INT-DR0023	75x100x160	80	450	1,5-2-2,5	380V,3 hızlı (Speeds)	320

**INT-SG0008**
**HAMUR AÇMA MAKİNESİ  
DOUGH SHEETER**

**INT-TR0001**
**EKMEK DİLİMLEME MAKİNESİ  
BREAD SLICER**

MODEL	EBATLAR	GÜÇ	N. AĞIRLIK
	DIMENSIONS	POWER	N.WEIGHT
	mm	kW	Kg
INT-SG0008	400x650x950	0,5 kW 220 V	22
INT-SG0009	550x500x700	0,5 kW 220 V	22

MODEL	EBATLAR	MODEL	MOTOR	MAX. EKMEK UZ.	MAX. EKMEK KA.	DİLİM KAL.	BAŞAK SAY.	KAPASİTE	NET AĞ.
	DIMENSIONS	MODEL	MOTOR	MAX. BREAD LENGTH	MAX. BREAD CAP.	SLICE THICKNESS	NUMBER OF KNIFE	CAPACITY	N.WEIGHT
	mm		kW	mm	Kg	mm	Adet / Pcs.	Ekmek/Saat Bread/ Hour	Kg
INT-TR0001	1140x780x700	Normal Ekmek Standart Bread	0,37	450	2-8	16	30	500	140

**INT-TR0021**
**KLASİK HAMUR KARMA  
CLASSIC DOUGH KNEADING MACHINE**

Pizza Hamuru, Gevrek, Börek, Yufka vs. bütün mayalı ve ekmek hamurları yoğurmaktadır. Gövde çelik sacdan yapılmış olup elektrostatik fırın boya ile boyanmıştır. Hamur kazanı krom, hamur kancası krom kaplamadır.

Pizza dough kneads, crispy, pastry, filo pastry etc. all leavened dough bread dough. Body is made of steel sheet and painted electrostatic oven paint. Dough boiler is chrome, dough hook is chrome plated.



MODEL	EBATLAR	HAMUR KAP.	KAZAN HACMİ	MOTOR G. HAMUR K.	ÖLÇÜLER	AĞIRLIK	KAZAN ÖLÇ.
	DIMENSIONS	DOUGH CAP.	BOWL VOLUME		DIMENSIONS	WEIGHT	BOWL DIMENSIONS
	lt	Kg	lt	kW	cm	Kg	çap/derinlik
INT-TR0013	20	15	10	0,37	62x42x65	68	360x200
INT-TR0017	40	25	15	0,55 / 220V	78x65x78	98	430x240
INT-TR0016	40	25	15	0,55 / 380V	78x65x78	98	430x240
INT-TR0020	50	35	25	0,55 / 380	80x67x96	114	500x280
INT-TR0025	70	50	35	0,75	80x80x60	125	600x320
INT-TR0026	70	50	35	0,4-0,70(750-1500)	80x80x60	125	600x320
INT-TR0010	120	85	50	1,1	85x125x95	165	750x380

**INT-YM0045**

 KIYMA MAKİNESİ  
MEAT MINCER

**INT-YM0052**

 KIYMA MAKİNESİ  
MEAT MINCER

**INT-YM0056**

 KIYMA MAKİNESİ  
MEAT MINCER

MODEL	MOTOR GÜÇ	ELEKTRİK GİRİŞİ	ÖLÇÜLER	KAPASİTE
	MOTOR POWER	ELECTRIC INLET	DIMENSIONS	CAPACITY
	kW	V	cm	Kg/h
INT-YM0045	1,5	400	350x680x400	300
INT-YM0052	3	400	380x785x480	600
INT-YM0056	4	400	690x1020x1115	900
INT-YM0039	0,75	400	315x600x300	90
INT-YM0038	0,75	220	315x600x300	90
INT-YM0042	1,5	220	350x680x400	250
INT-YM0053	3	400	380x785x435	600
INT-YM0050	2,2	220	380x785x435	500
INT-YM0055	4	400	650x1020x540	900
INT-YM0044	1,5	400	350x680x460	300
INT-YM0043	1,5	220	350x680x460	250
INT-YM0051	2,2	220	350x785x480	500





Arabalar

Trolleys



# MUTFAK ARABALARI

## TROLLEYS



- Tamamı AISI304 kalite 18/8 Cr-Ni paslanmaz çelik malzemelerden üretilmiştir.
- Ayaklarda ikisi frenli, ikisi frensiz, 360 derece dönebilir yapıda 4 adet tekerlek vardır.
- Köşelerde çarpmalara karşı darbe sönmölendirici lastik tamponlar vardır.

- All devices and equipment are manufactured from AISI304 grade 18/8 Cr/Ni stainless steel
- 4 wheels turning 360 degrees and two of them with brakes.
- 4 rubber bumpers in corners.



**INO-ASN 100**

SERVİS ARABASI  
SERVICE TROLLEY



MODEL	EBAT DIMENSIONS
	mm
INO-ASN 100	800x500x950



**INO-ASN 200**

SERVİS ARABASI  
SERVICE TROLLEY



MODEL	EBAT DIMENSIONS
	mm
INO-ASN 200	800x500x950



**INO-AMT 100**

KASA TAŞIMA ARABASI  
PLATFORM TROLLEY



MODEL	EBAT DIMENSIONS
	mm
INO-AMT 100	1000x650x850



AMK100 tek kapaklı AMK200 çift kapaklıdır.  
AMK100 with single cover, AMK200 with double cover

**INO-AMK**

UN ve ŞEKER ARABASI  
INGREDIENT TROLLEY



MODEL	EBAT DIMENSIONS
	mm
INO-AMK 100	410x460x620
INO-AMK 200	550x735x620



**INO-ABB 100**

BULAŞIK BASMA ARABASI  
DISH SOAKING TROLLEY



MODEL	EBAT DIMENSIONS
	mm
INO-ABB 100	600x500x700



**INO-ASB 100**

SEBZE BASMA ARABASI  
VEGETABLE SOAKING TROLLEY



MODEL	EBAT DIMENSIONS
	mm
INO-ASB 100	600x500x700



**INO-AKT 100**

KASET TAŞIMA ARABASI  
RACK TROLLEY



MODEL	EBAT DIMENSIONS
	mm
INO-AKT 100	550x550x780



**INO-AKT 200**

KASET TAŞIMA ARABASI  
RACK COLLECTION TROLLEY



MODEL	EBAT DIMENSIONS
	mm
INO-AKT 200	560x530x1650



**INO-AKZ 100**

KAZAN TAŞIMA ARABASI  
POT TROLLEY



MODEL	EBAT DIMENSIONS
	mm
INO-AKZ 100	600x600x570
INO-AKZ 200	600x700x850



**INO-ATG 100**

TEPSİ TAŞIMA ARABASI  
TRAY COLLECTING TROLLEY



MODEL	EBATLAR VE ÖZELLİK DIMENSIONS
	mm
INO-ATG 100	670x595x1650 GN 2/1x65 mm tepsi için 670x595x1650 GN 2/1x65 mm trays



**INO-ATT 100**

TEPSİ TAŞIMA ARABASI  
TRAY COLLECTING TROLLEY



MODEL	EBATLAR VE ÖZELLİK DIMENSIONS
	mm
INO-ATT 100	400x600 mm. tepsi için, 460x625x1650 mm. 460x625x1650 400x600 mm trays



**INO-ATY 100**

TEPSİ TAŞIMA ARABASI  
TRAY COLLECTING TROLLEY



MODEL	EBAT / DIMENSIONS
	mm
INO-ATY 100	600x700x850



**INO-ATK**

KİRLİ TEPSİ TOPLAMA ARABASI  
TRAY COLLECTION TROLLEY



MODEL	EBAT / DIMENSIONS
	mm
INO-ATK 100	590x775x1500
INO-ATK 200	835x560x1500

37x53cm  
28 adet tepsi kapasiteli  
37x53cm 28pcs cap.



**INO-ATI 100**

TABAK ISITMA ARABASI  
HEATED PLATE TROLLEY



MODEL	EBATLAR VE ÖZELLİK DIMENSIONS
	mm
INO-ATI 100	450x450x850 50 Tabak kapasiteli 450x450x850 50 Plt cap.



**INO-ATI 200**

TABAK ISITMA ARABASI  
HEATED PLATE TROLLEY



MODEL	EBATLAR VE ÖZELLİK DIMENSIONS
	mm
INO-ATI 200	1000x450x850 100 Tabak kapasiteli 1000x450x850 100 Plt cap.



**INO-ABT 100**

**BULAŞIK TOPLAMA ARABASI**  
**DISH COLLECTING TROLLEY**

MODEL	EBAT/ DIMENSION
	mm
INO-ABT 100	800x500x950 60 mm derinlikte havuz 800x500x950 60mm deep well



**INO-ABT 200**

**BULAŞIK TOPLAMA ARABASI**  
**DISH COLLECTING TROLLEY**

MODEL	EBAT/ DIMENSION
	mm
INO-ABT 200	800x500x950 120 mm derinlikte havuz 800x500x950 120mm deep well



**INO-ABR 100**



**INO-ABR 101**



**INO-ABR 200**



**INO-ABR 201**



**INO-ABR 100D**



**INO-ABR 101D**



**INO-ABR 102D**



**INO-ABR 103D**



\*Demontedir. / Disassembled.

**TEPSİ TOPLAMA ARABALARI / TRAY COLLECTING TROLLEY**

MODEL	EBATLAR VE ÖZELLİK / DIMENSIONS
	mm
INO-ABR 100	470x600x1260 36 ad. / pcs. - 28x40 cm tepsi/tray
INO-ABR 101	600x780x1260 20 ad. / pcs. - 37x53 cm tepsi/tray
INO-ABR 200	920x600x1260 72 ad. / pcs. - 28x40 cm tepsi/tray
INO-ABR 201	1170x780x1260 40 ad. / pcs. - 37x53 cm tepsi/tray
INO-ABR100D	470x300x1150 18 ad. / pcs. - 40x29 cm tepsi/tray
INO-ABR101D	440x590x1200 18 ad. / pcs. - 37x58 cm tepsi/tray
INO-ABR102D	470x590x1200 18 ad. / pcs. - 40x60 cm tepsi/tray
INO-ABR103D	600x660x1200 10 ad. / pcs. - 2 / 1 GN

**INO-AEA 100**



**ET ASKI ARABASI**  
**MEAT HANGING TROLLEY**

MODEL	EBAT/ DIMENSION
	mm
INO-AEA 100	1200x600x1750



**INT-MZ0001**



**ÇÖP ARABASI**  
**WASTE TROLLEY**

MODEL	EBAT/ DIMENSION
	mm
INT-MZ0001	400x500 - 50 lt.





**AYS 110-120**

**YEMEK SERVİS ARABASI  
DINING TROLLEY**



**INT-UC0066**

**MALZEME ARABASI  
INGREDIENT TROLLEY**

MODEL	EBATLAR VE ÖZELLİK/DIMENSIONS
	mm
AYS 110-120	3,4 kW / 220 V

MODEL	AÇIKLAMA/ FEATURES
	mm
INT-UC0066	420x750x710 Plastik/Plastic, 102 lt.10 Kg.



**INO-AGN 100**

**MALZEME ARABASI  
INGREDIENT TROLLEY**



**INO-AGN 200**

**MALZEME ARABASI  
INGREDIENT TROLLEY**



**INO-AGN 201**

**MALZEME ARABASI  
INGREDIENT TROLLEY**



MODEL	EBAT / DIMENSION
	mm
INO-AGN 100	560x355x500 1x1/1GN
INO-AGN 200	680x560x500 1x2/1GN
INO-AGN 201	680x560x700 1x2/1GN



## BANKET ARABALARI



BANKET  
ARABALARI  
BANQUET  
TROLLEY

**INO-ABS-101S**



**INO-ABS 102**



**INO-ABS-202**



**INO-ABS-201S**



**INO-ABS 12**



**INO-ABS 15**



MODEL	AÇIKLAMA / FEATURES
	mm
INO-ABS-102	707X890X1565- Isıtmalı/Nemlendirilmiş/Dijital Göstergeli/ 10 X GN2/1 veya 20 X GN1/1 Tepsi Kapasiteli 707X890X1565- Heated/Humidified/Digital Display/ 10 X GN2/1 or 20 X GN1/1 Tray Capacity
INO-ABS-101 S	707X890X1565- Isıtmalı/ 10 X GN2/1 veya 20 X GN1/1 Tepsi Kapasiteli 707X890X1565- Heated/10 X GN2/1 or 20 X GN1/1 Tray Capacity
INO-ABS-202	1354X890X1565- Isıtmalı/Nemlendirilmiş/Dijital Göstergeli/ 20 X GN2/1 veya 40 X GN1/1 Tepsi Kapasiteli 1354X890X1565- Heated/Humidified/Digital Display/ 20 X GN2/1 or 40 X GN1/1 Tray Capacity
INO-ABS-201 S	1354X890X1565- Isıtmalı/ 20 X GN2/1 veya 40 X GN1/1 Tepsi Kapasiteli 1354X890X1565- Heated/20 X GN2/1 or 40 X GN1/1 Tray Capacity
INO-ABS 12	690X890X1150- Isıtmalı/Nemlendirilmiş/Dijital Göstergeli/ 12 X GN1/1 veya 6 X GN2/1 Tepsi Kapasiteli 690X890X1150- Heated/Humidified/Digital Display/ 12 X GN1/1 or 6 X GN2/1 Tray Capacity
INO-ABS 15	502X770X1480- Isıtmalı/Nemlendirilmiş/Dijital Göstergeli/ 15 X GN1/1 Tepsi Kapasiteli 502X770X1480- Heated/Humidified/Digital Display/ 15 X GN1/1 Tray Capacity



**BANKET ARABASI RAFI  
BANQUET TROLLEY GRID**

MODEL	AÇIKLAMA / FEATURES
	mm
2028054050	650x530 (GN2/1) Izgara komple kromajlı Chrome-plated
2028054051	650x530 (GN2/1) Izgara komple paslanmaz Stainless steel



**BANKET ARABASI RAFI  
BANQUET TROLLEY GRID**

MODEL	AÇIKLAMA / FEATURES
	mm
2022133041	530x325 (GN1/1) Izgara komple kromajlı Chrome-plated
2047003050	530x325 (GN1/1) Izgara komple paslanmaz Stainless steel



**INT-UC0029**

**TABAK TAŞIMA ARABASI  
PLATE TROLLEY**

MODEL	AÇIKLAMA/ FEATURES
	mm
INT-UC0029	730x730x815 Ayarlanabilir/ Adjustable 4 bölmeli/Parts
INT-UC0030	1100x710x800 Ayarlanabilir/ Adjustable 6 bölmeli/Parts



**INT-UC0038**

**ORDÖVR ARABASI  
PLATE STACKER TROLLEY**

MODEL	KAPASİTE/ CAPACITY
	Tabak/Plate
INT-UC0038	80



**INO-AEC 100**

**ET ÇÖZDÜRME ARABASI  
MEAT DEICING TROLLEY**

MODEL	KAPASİTE/ CAPACITY
	Tabak
INO-AEC 100	4 katti, GN2/1x150mm 4 kap kapasiteli 4 tiers, GN2/1x150mm 4 pcs. cont. capacity



**INT-VA0089**

**ORDÖVR ARABASI  
PLATE STACKER TROLLEY**

MODEL	KAPASİTE/ CAPACITY
	Tabak / Plate
INT-VA0053	Araba Örtüsü
INT-VA0089	100





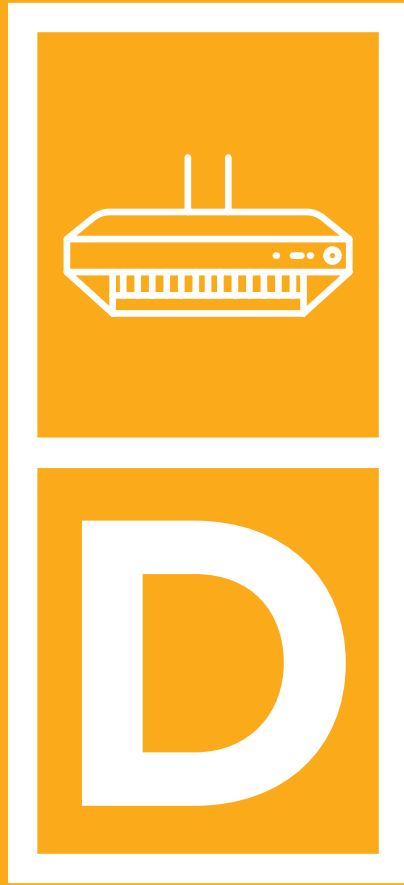

**Davlumbazlar, Yer  
Izgaraları, Yağ Tutucular**

Hoods, Floor Grids  
Oil Retainers



# DAVLUMBAZLAR

## HOODS



- 1.0 mm kalınlığında paslanmaz çelik sacdan üretilmiştir.
- Davlumbazın tavana montajı çelik dubellerle ve üzeri plastik kaplı çelik askı halatlarıyla yapılır.
- 60 mm eninde yağ kanalı vardır. İstenirse özel etanj tip armatürlerle aydınlatma imkanı vardır.
- Davlumbaz filtreleri, uygun eğimde ve üzerinde biriken yağların davlumbaz çevresindeki yağ kanallarında birikmesini sağlayacak formda, kolaylıkla çıkartılıp temizlenebilir, birbirine geçme trapez kesitli alev ve kıvılcımın geçişini önleyecek yapıdadır.

- Made of 1.00mm thick stainless steel sheet.
- Possible to fix tight lightening system.
- Filters are specially designed to collect oil to the channels
- Dismounting and cleaning are very easy.
- Protection against flame and spark.

**DUVAR TİPİ DAVLUMBAZ / FİLTRESİZ**  
**HOOD / WALL TYPE / WITHOUT FILTER**
**DDS**

MODEL	EBATLAR / DIMENSIONS
	mm
INO-DDS 101K	1000X800X500
INO-DDS 151K	1500X800X500
INO-DDS 201K	2000X800X500
INO-DDS 251K	2500X800X500
INO-DDS 301K	3000X800X500
INO-DDS 102K	1000X970X500
INO-DDS 152K	1500X970X500
INO-DDS 202K	2000X970X500
INO-DDS 252K	2500X970X500
INO-DDS 302K	3000X970X500
INO-DDS 352K	3500X970X500
INO-DDS 402K	4000X970X500
INO-DDS 123K	1200X1170X500
INO-DDS 153K	1500X1170X500
INO-DDS 203K	2000X1170X500
INO-DDS 253K	2500X1170X500
INO-DDS 303K	3000X1170X500
INO-DDS 353K	3500X1170X500
INO-DDS 403K	4000X1170X500
INO-DDS 453K	4500X1170X500
INO-DDS 503K	5000X1170X500
INO-DDS 553K	5500X1170X500
INO-DDS 603K	6000X1170X500
INO-DDS 154K	1500X1470X500
INO-DDS 204K	2000X1470X500
INO-DDS 254K	2500X1470X500
INO-DDS 304K	3000X1470X500
INO-DDS 354K	3500X1470X500
INO-DDS 404K	4000X1470X500
INO-DDS 454K	4500X1470X500
INO-DDS 504K	5000X1470X500
INO-DDS 554K	5500X1470X500
INO-DDS 604K	6000X1470X500

**DUVAR TİPİ DAVLUMBAZ / ALEV TUTUCU FİLTRELİ**  
**HOOD / WALL TYPE / WITH FLAME GUARD FILTER**
**DDF**

MODEL	EBATLAR / DIMENSIONS
	mm
INO-DDF 101K	1000X800X500
INO-DDF 151K	1500X800X500
INO-DDF 201K	2000X800X500
INO-DDF 251K	2500X800X500
INO-DDF 301K	3000X800X500
INO-DDF 102K	1000X970X500
INO-DDF 152K	1500X970X500
INO-DDF 202K	2000X970X500
INO-DDF 252K	2500X970X500
INO-DDF 302K	3000X970X500
INO-DDF 352K	3500X970X500
INO-DDF 402K	4000X970X500
INO-DDF 123K	1200X1170X500
INO-DDF 153K	1500X1170X500
INO-DDF 203K	2000X1170X500
INO-DDF 253K	2500X1170X500
INO-DDF 303K	3000X1170X500
INO-DDF 353K	3500X1170X500
INO-DDF 403K	4000X1170X500
INO-DDF 453K	4500X1170X500
INO-DDF 503K	5000X1170X500
INO-DDF 553K	5500X1170X500
INO-DDF 603K	6000X1170X500
INO-DDF 154K	1500X1470X500
INO-DDF 204K	2000X1470X500
INO-DDF 254K	2500X1470X500
INO-DDF 304K	3000X1470X500
INO-DDF 354K	3500X1470X500
INO-DDF 404K	4000X1470X500
INO-DDF 454K	4500X1470X500
INO-DDF 504K	5000X1470X500
INO-DDF 554K	5500X1470X500
INO-DDF 604K	6000X1470X500



**ORTA TİP DAVLUMBAZ / FİLTRESİZ  
HOOD / ISLAND TYPE / WITHOUT FILTER**
**DOS**

**ORTA TİP DAVLUMBAZ / FİLTRELİ  
HOOD / ISLAND TYPE / WITH FLAME GUARD FILTER**
**DOF**

MODEL	EBATLAR / DIMENSIONS
	mm
INO-DOS 154K	1500X1470X500
INO-DOS 204K	2000X1470*500
INO-DOS 254K	2500X1470X500
INO-DOS 304K	3000X1470X500
INO-DOS 354K	3500X1470X500
INO-DOS 404K	4000X1470X500
INO-DOS 454K	4500X1470X500
INO-DOS 504K	5000X1470X500
INO-DOS 554K	5500X1470X500
INO-DOS 604K	6000X1470X500
INO-DOS 256K	2500X1970X500
INO-DOS 306K	3000X1970X500
INO-DOS 356K	3500X1970X500
INO-DOS 406K	4000X1970X500
INO-DOS 456K	4500X1970X500
INO-DOS 506K	5000X1970X500
INO-DOS 556K	5500X1970X500
INO-DOS 606K	6000X1970X500
INO-DOS 258K	2500X2470X500
INO-DOS 308K	3000X2470X500
INO-DOS 358K	3500X2470X500
INO-DOS 408K	4000X2470X500
INO-DOS 458K	4500X2470X500
INO-DOS 508K	5000X2470X500
INO-DOS 558K	5500X2470X500
INO-DOS 608K	6000X2470X500
INO-DOS 309K	3000X2970X500
INO-DOS 359K	3500X2970X500
INO-DOS 409K	4000X2970X500
INO-DOS 459K	4500X2970X500
INO-DOS 509K	5000X2970X500
INO-DOS 559K	5500X2970X500
INO-DOS 609K	6000X2970X500



MODEL	EBATLAR / DIMENSIONS
	mm
INO-DOF 154K	1500X1470X500
INO-DOF 204K	2000X1470X500
INO-DOF 254K	2500X1470X500
INO-DOF 304K	3000X1470X500
INO-DOF 354K	3500X1470X500
INO-DOF 404K	4000X1470X500
INO-DOF 454K	4500X1470X500
INO-DOF 504K	5000X1470X500
INO-DOF 554K	5500X1470X500
INO-DOF 604K	6000X1470X500
INO-DOF 256K	2500X1970X500
INO-DOF 306K	3000X1970X500
INO-DOF 356K	3500X1970X500
INO-DOF 406K	4000X1970X500
INO-DOF 456K	4500X1970X500
INO-DOF 506K	5000X1970X500
INO-DOF 556K	5500X1970X500
INO-DOF 606K	6000X1970X500
INO-DOF 258K	2500X2470X500
INO-DOF 308K	3000X2470X500
INO-DOF 358K	3500X2470X500
INO-DOF 408K	4000X2470X500
INO-DOF 458K	4500X2470X500
INO-DOF 508K	5000X2470X500
INO-DOF 558K	5500X2470X500
INO-DOF 608K	6000X2470X500
INO-DOF 309K	3000X2970X500
INO-DOF 359K	3500X2970X500
INO-DOF 409K	4000X2970X500
INO-DOF 459K	4500X2970X500
INO-DOF 509K	5000X2970X500
INO-DOF 559K	5500X2970X500
INO-DOF 609K	6000X2970X500

**DUVAR TİP DAVLUMBAZ / HAVA PERDELİ  
HOOD / WALL TYPE / WITH AIR CURTAIN**
**DDH**

MODEL	EBATLAR / DIMENSIONS
	mm
INO-DDH 101	1000X800X500
INO-DDH 151	1500X800X500
INO-DDH 201	2000X800X500
INO-DDH 251	2500X800X500
INO-DDH 301	3000X800X500
INO-DDH 102	1000X970X500
INO-DDH 152	1500X970X500
INO-DDH 202	2000X970X500
INO-DDH 252	2500X970X500
INO-DDH 302	3000X970X500
INO-DDH 352	3500X970X500
INO-DDH 402	4000X970X500
INO-DDH 123	1200X1170X500
INO-DDH 153	1500X1170X500
INO-DDH 203	2000X1170X500
INO-DDH 253	2500X1170X500
INO-DDH 303	3000X1170X500
INO-DDH 353	3500X1170X500
INO-DDH 403	4000X1170X500
INO-DDH 453	4500X1170X500
INO-DDH 503	5000X1170X500
INO-DDH 553	5500X1170X500
INO-DDH 603	6000X1170X500
INO-DDH 154	1500X1470X500
INO-DDH 204	2000X1470X500
INO-DDH 254	2500X1470X500
INO-DDH 304	3000X1470X500
INO-DDH 354	3500X1470X500
INO-DDH 404	4000X1470X500
INO-DDH 454	4500X1470X500
INO-DDH 504	5000X1470X500
INO-DDH 554	5500X1470X500
INO-DDH 604	6000X1470X500

**ORTA TİP DAVLUMBAZ / HAVA PERDELİ  
HOOD / ISLAND TYPE / WITH AIR CURTAIN**
**DOH**

MODEL	EBATLAR / DIMENSIONS
	mm
INO-DOH 254	2500X1470X500
INO-DOH 304	3000X1470X500
INO-DOH 354	3500X1470X500
INO-DOH 404	4000X1470X500
INO-DOH 454	4500X1470X500
INO-DOH 504	5000X1470X500
INO-DOH 554	5500X1470X500
INO-DOH 604	6000X1470X500
INO-DOH 256	2500X1970X500
INO-DOH 306	3000X1970X500
INO-DOH 356	3500X1970X500
INO-DOH 406	4000X1970X500
INO-DOH 456	4500X1970X500
INO-DOH 506	5000X1970X500
INO-DOH 556	5500X1970X500
INO-DOH 606	6000X1970X500
INO-DOH 258	2500X2470X500
INO-DOH 308	3000X2470X500
INO-DOH 358	3500X2470X500
INO-DOH 408	4000X2470X500
INO-DOH 458	4500X2470X500
INO-DOH 508	5000X2470X500
INO-DOH 558	5500X2470X500
INO-DOH 608	6000X2470X500
INO-DOH 658	6500X2470X500



Not: Hava perdeli davlumbazlarda floresan aydınlatma standarttır.

Note: Fluorescent lighting included in hoods with air curtain.



**INO-DCO**

**ÇAY OCAĞI DAVLUMBAZI  
HOOD FOR TEA MAKER**



MODEL	EBATLAR / DIMENSIONS
	mm
INO-DCO080	800X500X400
INO-DCO100	1000X500X400
INO-DCO120	1200X500X400



**2044003050**

**AYARLANABİLİR MENFEZ  
ADJUSTABLE AIR VENT**



MODEL	EBATLAR / DIMENSIONS
	mm
2044003050	425x250



Fırın lambalı  
Oven Lamp

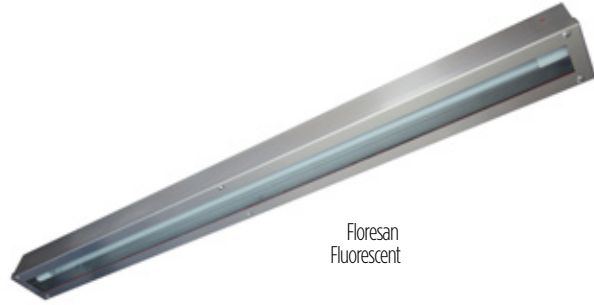

Floresan  
Fluorescent

**AYDINLATMA İLAVESİ  
ADDITIONAL LIGHTING**

MODEL	EBATLAR VE ÖZELLİKLER / DIMENSIONS AND FEATURES
	mm
2044000720	Duvar tipi: 1000, 1200, 1500 mm için 1 adet; 3000, 3500 mm için 2 adet gereklidir. Wall type: 1 pc for 1000, 1200, 1500mm, 2 pcs for 3000, 3500mm
2044001820	Orta tip: 1500 mm için 2 adet; 3000, 3500 mm için 4 adet gereklidir. Island type: 2 pcs for 1500mm, 4 pcs for 3000, 3500mm
2044000760	Duvar tipi: 2000 mm için 1 adet; 4000, 4500 mm için 2 adet, 6000 mm için 3 adet gereklidir. Wall type: 1 pc for 2000mm, 2 pcs for 4000, 4500mm, 3 pcs for 6000mm
2044001821	Orta tip: 2000 mm için 2 adet; 4000, 4500 mm için 4 adet, 6000 mm için 6 adet gereklidir. Island type: 2 pcs for 2000mm, 4 pcs for 4000, 4500mm, 6 pcs for 6000mm
2044000690	Duvar tipi: 2500 mm için 1 adet; 5000, 5500 mm için 2 adet gereklidir. Wall type: 1 pc for 2500mm, 2 pcs for 5000, 5500mm
2044001830	Orta tip: 2500 mm için 2 adet; 5000, 5500 mm için 4 adet gereklidir. Island type: 2 pcs for 2500mm, 4 pcs for 5000, 5500mm



---

# YER IZGARALARI YAĞ TUTUCULAR

.....

FLOOR GRIDS  
AND OIL  
RETAINERS



**INT-BS0**
**YER IZGARASI / TAVASIZ**  
**FLOOR GRID WITHOUT POT**

MODEL	EBAT/ DIMENSION
	mm
INT-BS0170	300X300
INT-BS0171	300X400
INT-BS0173	300X500
INT-BS0174	300X741
INT-BS0175	300X941
INT-BS0160	300X1184
INT-BS0161	300X1384
INT-BS0162	300X1626
INT-BS0163	300X1826
INT-BS0164	300X2068
INT-BS0165	300X2268
INT-BS0167	300X2510
INT-BS0168	300X2710
INT-BS0169	300X2952

MODEL	EBAT/ DIMENSION
	mm
INT-BS0185	400X300
INT-BS0186	400X400
INT-BS0187	400X500
INT-BS0188	400X741
INT-BS0189	400X941
INT-BS0176	400X1184
INT-BS0177	400X1384
INT-BS0178	400X1626
INT-BS0179	400X1826
INT-BS0180	400X2068
INT-BS0181	400X2268
INT-BS0182	400X2510
INT-BS0183	400X2710
INT-BS0184	400X2952

**YER IZGARASI / TAVALI / ALTAN ÇIKIŞLI / EĞİMSİZ**  
**FLOOR GRID / WITH COLLECTING POT / DISCHARGE FROM THE BOTTOM / NOT**  
**INCLINED**
**DN 70 PVC (0/75 mm)**

MODEL	EBAT/ DIMENSION
	mm
INT-BS0035	300X300
INT-BS0039	300X400
INT-BS0041	300X500
INT-BS0043	300X741
INT-BS0057	400X400
INT-BS0059	400X500
INT-BS0061	400X741

 Sığ tip  
 Shallow Type

**DN 100 PVC (1/110 mm)**

MODEL	EBAT/ DIMENSION
	mm
INT-BS0034	300X300
INT-BS0038	300X400
INT-BS0040	300X500
INT-BS0042	300X741
INT-BS0056	400X400
INT-BS0058	400X500
INT-BS0060	400X741

 DN 70/75 pık çıkıřlar için liste fiyatına 10 ilave ediniz.  
 Please add 10 to the list price for DN 70/75 peak outputs.



YER IZGARASI / TAVALI / ALT TAN ÇIKIŞLI / BİR YÖNE EĞİMLİ  
FLOOR GRID / WITH COLLECTING POT / DISCHARGE FROM THE BOTTOM / INCLINED  
TO ONE SIDE

Siğ tip  
Shallow Type

Ø 70 DN

MODEL	GENİŞLİK / LENGTH
	mm
INT-BS0045	300X941
INT-BS0020	300X1184
INT-BS0023	300X1384
INT-BS0026	300X1626
INT-BS0029	300X1826
INT-BS0032	300X2068

Ø 100 DN

MODEL	GENİŞLİK / LENGTH
	mm
INT-BS0044	300X941
INT-BS0019	300X1184
INT-BS0022	300X1384
INT-BS0025	300X1626
INT-BS0028	300X1826
INT-BS0031	300X2068

INT-BS0063	400X941
INT-BS0047	400X1184
INT-BS0049	400X1384
INT-BS0051	400X1626
INT-BS0053	400X1826
INT-BS0055	400X2068

INT-BS0062	400X941
INT-BS0046	400X1184
INT-BS0048	400X1384
INT-BS0050	400X1626
INT-BS0052	400X1826
INT-BS0054	400X2068

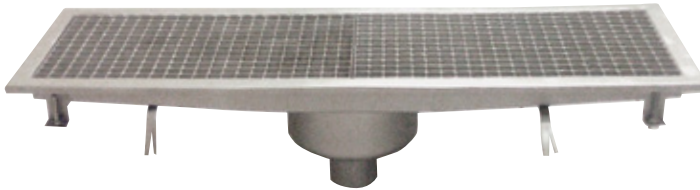

YER IZGARASI / TAVALI / ALT TAN ÇIKIŞLI / ORTAYA EĞİMLİ  
FLOOR GRID / WITH COLLECTING POT / DISCHARGE FROM THE BOTTOM / INCLINED  
TO THE CENTER

Ø 70 DN

MODEL	GENİŞLİK / LENGTH
	mm
INT-BS0216	300X941
INT-BS0200	300X1184
INT-BS0202	300X1384
INT-BS0206	300X1626
INT-BS0209	300X1826
INT-BS0211	300X2068

Ø 100 DN

MODEL	GENİŞLİK / LENGTH
	mm
INT-BS0215	300X941
INT-BS0199	300X1184
INT-BS0201	300X1384
INT-BS0205	300X1626
INT-BS0208	300X1826
INT-BS0210	300X2068

INT-BS0230	400X941
INT-BS0219	400X1184
INT-BS0221	400X1384
INT-BS0224	400X1626
INT-BS0226	400X1826
INT-BS0228	400X2068

INT-BS0229	400X941
INT-BS0218	400X1184
INT-BS0220	400X1384
INT-BS0223	400X1626
INT-BS0225	400X1826
INT-BS0227	400X2068

Siğ tip  
Shallow Type



**YER IZGARASI / TAVALI / YANDAN ÇIKIŞLI / EĞİMSİZ**  
**FLOOR GRID / WITH COLLECTING POT / DISCHARGE FROM ONE SIDE / NOT INCLINED**

**DN 70 PVC (0/75 mm)**

Sığ tip  
 Shallow Type

MODEL	EBAT / DIMENSION
mm	
INT-BS0357	300X300
INT-BS0361	300X400
INT-BS0363	300X500
INT-BS0366	300X741
INT-BS0375	400X400
INT-BS0377	400X741

DN 70/75 pık çıkıřlar için liste fiyatına 10 ilave ediniz.  
 Please add 10 to the list price for DN 70/75 peak outputs.



**YER IZGARASI / TAVALI / YANDAN ÇIKIŞLI / BİR YÖNE EĞİMLİ**  
**FLOOR GRID / WITH COLLECTING POT / DISCHARGE FROM ONE SIDE / INCLINED TO ONE SIDE**

**DN 70 PVC (0/75 mm)**

Sığ tip  
 Shallow Type

MODEL	EBAT / DIMENSION
mm	
INT-BS0368	300X941
INT-BS0350	300X1184
INT-BS0351	300X1384
INT-BS0353	300X1626
INT-BS0354	300X1826
INT-BS0355	300X2068
INT-BS0381	400X941
INT-BS0369	400X1184
INT-BS0370	400X1384
INT-BS0371	400X1626
INT-BS0372	400X1826
INT-BS0373	400X2068

DN 70/75 pık çıkıřlar için liste fiyatına 10 ilave ediniz.  
 Please add 10 to the list price for DN 70/75 peak outputs.

DAVLUMBAZLAR - YER IZGARALARI - YAĞ TUTUCULAR / YER IZGARALARI  
 HOODS, FLOOR GRIDS OIL RETAINERS / FLOOR GRIDS OIL RETAINERS



YER IZGARASI / TAVALI / YANDAN ÇIKISLI / ORTAYA EĞİMLİ  
FLOOR GRID / WITH COLLECTING POT / DISCHARGE FROM ONE SIDE / INCLINED TO  
THE CENTER

Şığ tip  
Shallow Type

#### DN 70 PVC (0/75 mm)

MODEL	EBAT / DIMENSION
	mm
INT-BS0301	300X941
INT-BS0283	300X1184
INT-BS0287	300X1384
INT-BS0290	300X1626
INT-BS0293	300X1826
INT-BS0297	300X2068
INT-BS0315	400X941
INT-BS0304	400X1184
INT-BS0306	400X1384
INT-BS0308	400X1626
INT-BS0310	400X1826
INT-BS0312	400X2068

DN 70/75 pik çıkışlar için liste fiyatına 10 ilave ediniz.  
Please add 10 to the list price for DN 70/75 peak outputs.



#### TA MKT

#### YAĞ TUTUCU OIL RETAINER

MODEL	KAPASİTE CAPACITY	EBAT DIMENSION
		mm
INT-BS0320	0,25 Lt/sn/sec	630x400x490
INT-BS0321	0,50 Lt/sn/sec	730x490x490
INT-BS0322	0,75 Lt/sn/sec	780x590x490
INT-BS0323	1,00 Lt/sn	910x630x490

Tezgahaltı, Manuel, Katı Atık Tutuculu, Tekerlekli  
Undertable / Manuel control / Solid waste sorter / Mobile

#### TA MKS

#### YAĞ TUTUCU OIL RETAINER

MODEL	KAPASİTE CAPACITY	EBAT DIMENSION
		mm
INT-BS0316	0,25 Lt/sn/sec	710x400x330
INT-BS0317	0,50 Lt/sn/sec	730x490x360
INT-BS0318	0,75 Lt/sn/sec	780x590x360
INT-BS0319	1,00 Lt/sn/sec	910x630x360

Tezgahaltı, Manuel, Katı Atık Tutuculu, Sabit  
Undertable / Manuel control / Solid waste sorter

**YAĞ TUTUCU  
OIL RETAINER**
**YAĞ TUTUCU  
OIL RETAINER**

MODEL	KAPASİTE CAPACITY	EBAT DIMENSION
		mm
INT-BS0397	1 Lt/sn	1130X580X610
INT-BS0333	2 Lt/sn	1430X680X730
INT-BS0334	3 Lt/sn	1580X780X880
INT-BS0335	4 Lt/sn	1830X830X1005
INT-BS0336	5 Lt/sn	2130X980X1060

Zemin Tipi, Manuel, Katı Atık Tutuculu  
Floor type / Manuel control / Solid waste sorter

MODEL	KAPASİTE CAPACITY	EBAT DIMENSION
		mm
INT-BS0328	1 Lt/sn	1190X640X610
INT-BS0329	2 Lt/sn	1490X740X730
INT-BS0330	3 Lt/sn	1640X840X880
INT-BS0331	4 Lt/sn	1890X890X1005
INT-BS0332	5 Lt/sn	2190X1040X1060

Manuel, Katı Atık Tutuculu, Gömme Tip  
Manuel control / Solid waste sorter / Built-in



**YAĞ AYIRICILAR / ZEMİN ÜSTÜ VE GÖMME TİP  
OIL RETAINER / FLOOR TYPE AND BUILT-IN**

MODEL		KAPASİTE	YAĞ TOPLAMA KAPASİTESİ	GİRİŞ ÖLÇÜSÜ	ÇIKIŞ ÖLÇÜSÜ	GENİŞLİK	DERİNLİK	YÜKSEKLİK	GİRİŞ HATTI YÜKSEKLİĞİ	ÇIKIŞ HATTI YÜKSEKLİĞİ
		WORKING CAP	OIL CAP.	INLET	OUTLET	LENGHT	DEPTH	HEIGHT	INLET HEIGHT	OUTLET HEIGHT
		lt./sn./sec.							mm	mm
INT-BS0065	Zemin Tip Floor Type	1	40	DN100	DN100	580	1280	970	865	795
INT-BS0067	Gömme Tip Built-in	1	40	DN100	DN100	580	1280	970	865	795
INT-BS0068	Zemin Tip Floor Type	2	80	DN100	DN100	800	1580	970	865	795
INT-BS0069	Gömme Tip Built-in	2	80	DN100	DN100	800	1580	970	865	795
INT-BS0070	Zemin Tip Floor Type	3	120	DN100	DN100	1142	1580	970	865	795
INT-BS0071	Gömme Tip Built-in	3	120	DN100	DN100	1142	1580	970	865	795
INT-BS0072	Zemin Tip Floor Type	4	160	DN125	DN125	980	2300	1040	943	873
INT-BS0074	Zemin Tip Floor Type	5	200	DN125	DN125	980	2830	1040	943	873
INT-BS0075	Zemin Tip Floor Type	6	240	DN125	DN125	980	3080	1090	993	923
INT-BS0076	Zemin Tip Floor Type	7	280	DN150	DN150	980	3080	1280	1150	1080
INT-BS0066	Zemin Tip Floor Type	10	400	DN200	DN200	1350	3080	1350	1180	1110

Katı atık tutuculu yağ ayırıcılar - Çamur tutucu bölmeli gres ayırıcılar  
TSE Belgeli - Zemin üstü ve gömme Tip

DAVLUMBAZLAR - YER IZGARALARI - YAĞ TUTUCULAR / YER IZGARALARI  
HOODS, FLOOR GRIDS OIL RETAINERS / FLOOR GRIDS OIL RETAINERS

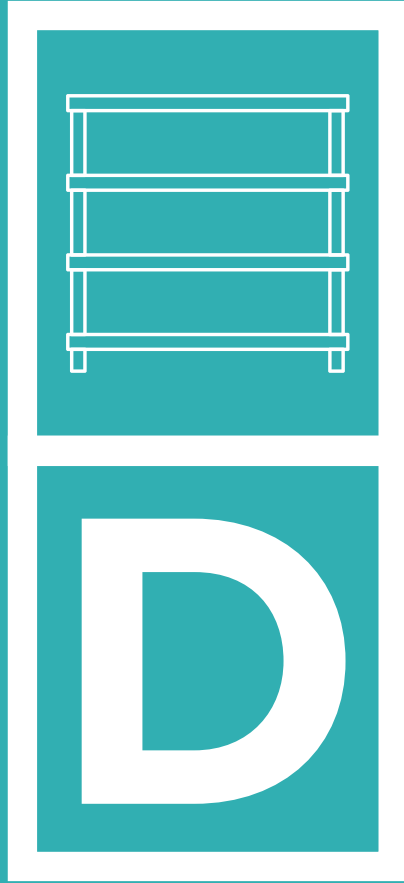



Depolama ve  
İstifleme Üniteleri

Storage Units



# İSTİF RAFLARI

## STORAGE SHELVES



- Tamamı paslanmaz çelik sactan üretilmiştir.
- Hijyenik, kolay temizlenebilir ve montaj gerektirmeyen pratik kullanıma sahiptir.
- Fonksiyonel tasarımı ile depolama ve kullanım kolaylığı sağlar.
- Demonte modellerde raf yükseklikleri istenilen ölçülerde ayarlanabilir.
- Müşteri isteğine göre düz tablalı, perfore tablalı, düz+perfore tablalı ya da aynı modellerde hareketli olarak yapılabilir.

- Made of stainless steel.
- Wide selection of design and dimensions.
- Hygienic convenient and easy to clean.
- Dismountable models are adjustable to request level.
- According customer request shelves can be flat, perforated and gridded.

**INO-IND**
**İSTİF RAFI / DÜZ TABLALI  
STORAGE SHELF / FLAT**

MODEL	EBATLAR / DIMENSIONS
mm	
INO-IND 094	900X400X1540
INO-IND 114	1100X400X1540
INO-IND 144	1390X400X1540
INO-IND 194	1900X400X1540

**INO-INP**
**İSTİF RAFI / PERFORE TABLALI  
STORAGE SHELF / PERFORATED**

MODEL	EBATLAR / DIMENSIONS
mm	
INO-INP 094	900X400X1540
INO-INP 114	1100X400X1540
INO-INP 144	1390X400X1540
INO-INP 194	1900X400X1540



MODEL	EBATLAR / DIMENSIONS
mm	

INO-IND 096	900X600X1540
INO-IND 116	1100X600X1540
INO-IND 146	1390X600X1540
INO-IND 196	1900X600X1540

INO-IND 090	900X700X1540
INO-IND 110	1100X700X1540
INO-IND 140	1390X700X1540
INO-IND 190	1900X700X1540

INO-IND 098	900X800X1540
INO-IND 118	1100X800X1540
INO-IND 148	1390X800X1540
INO-IND 198	1900X800X1540

MODEL	EBATLAR / DIMENSIONS
mm	

INO-INP 096	900X600X1540
INO-INP 116	1100X600X1540
INO-INP 146	1390X600X1540
INO-INP 196	1900X600X1540

INO-INP 090	900X700X1540
INO-INP 110	1100X700X1540
INO-INP 140	1390X700X1540
INO-INP 190	1900X700X1540

INO-INP 098	900X800X1540
INO-INP 118	1100X800X1540
INO-INP 148	1390X800X1540
INO-INP 198	1900X800X1540



**INO-IDD**

İSTİF RAFI / DEMONTE / DÜZ TABLALI  
STORAGE SHELF / FLAT / DISASSEMBLED



MODEL	EBATLAR / DIMENSIONS
	mm
INO-IDD 084	800X350X1600
INO-IDD 104	1000X350X1600
INO-IDD 124	1200X350X1600
INO-IDD 144	1390X350X1600
INO-IDD 164	1600X350X1600
INO-IDD 086	800X550X1600
INO-IDD 106	1000X550X1600
INO-IDD 126	1200X550X1600
INO-IDD 146	1390X550X1600
INO-IDD 166	1600X550X1600

**INO-IDP**

İSTİF RAFI / DEMONTE / PERFORE TABLALI  
STORAGE SHELF / PERFORATED / DISASSEMBLED



MODEL	EBATLAR / DIMENSIONS
	mm
INO-IDP 084	800X350X1600
INO-IDP 104	1000X350X1600
INO-IDP 124	1200X350X1600
INO-IDP 144	1390X350X1600
INO-IDP 164	1600X350X1600
INO-IDP 086	800X550X1600
INO-IDP 106	1000X550X1600
INO-IDP 126	1200X550X1600
INO-IDP 146	1390X550X1600
INO-IDP 166	1600X550X1600

**INO-IDK**

İSTİF RAFI / DEMONTE / KAZAN, TENCERE  
STORAGE SHELF / FOR POT-PAN / DISASSEMBLED



MODEL	EBATLAR / DIMENSIONS
	mm
INO-IDK 086	800X550X1600
INO-IDK 106	1000X550X1600
INO-IDK 126	1200X550X1600
INO-IDK 146	1390X550X1600
INO-IDK 166	1600X550X1600
INO-IDK 088	800X750X1600
INO-IDK 108	1000X750X1600
INO-IDK 128	1200X750X1600
INO-IDK 148	1390X750X1600
INO-IDK 168	1600X750X1600

**INO-ITD**

İSTİF TABLASI / DÜZ TABLALI  
DUNNAGE RACK / FLAT



MODEL	EBATLAR / DIMENSIONS
	mm
INO-ITD 094	900X400X570
INO-ITD 114	1100X400X570
INO-ITD 144	1400X400X570
INO-ITD 194	1900X400X570

INO-ITD 096	900X600X570
INO-ITD 116	1100X600X570
INO-ITD 146	1400X600X570
INO-ITD 196	1900X600X570

INO-ITD 098	900X800X570
INO-ITD 118	1100X800X570
INO-ITD 148	1400X800X570
INO-ITD 198	1900X800X570

**INO-ITP**

İSTİF TABLASI / PERFORE TABLALI  
DUNNAGE RACK / PERFORATED



MODEL	EBATLAR / DIMENSIONS
	mm
INO-ITP 094	900X400X570
INO-ITP 114	1100X400X570
INO-ITP 144	1400X400X570
INO-ITP 194	1900X400X570

INO-ITP 096	900X600X570
INO-ITP 116	1100X600X570
INO-ITP 146	1400X600X570
INO-ITP 196	1900X600X570

INO-ITP 098	900X800X570
INO-ITP 118	1100X800X570
INO-ITP 148	1400X800X570
INO-ITP 198	1900X800X570

**TEL İSTİF RAFLARI**  
**WIRE STORAGE SHELVES**

MODEL	EBATLAR / DIMENSIONS
	mm
INT-YU0028	Tel Raf/ Wire Shelf -4 Katlı / 4 Tiers- inox304 -36*91*183
INT-YU0003	Tel Raf/ Wire Shelf -4 Katlı / 4 Tiers- inox304 - 36*107*183
INT-YU0008	Tel Raf/ Wire Shelf -4 Katlı / 4 Tiers- inox304 - 36*122*183
INT-YU0013	Tel Raf/ Wire Shelf -4 Katlı / 4 Tiers- inox304 - 36*137*183
INT-YU0018	Tel Raf/ Wire Shelf -4 Katlı / 4 Tiers- inox304 - 36*152*183
INT-YU0023	Tel Raf/ Wire Shelf -4 Katlı / 4 Tiers- inox304 - 36*183*183

**TEL İSTİF RAFLARI**  
**WIRE STORAGE SHELVES**

MODEL	EBATLAR / DIMENSIONS
	mm
INT-YU0027	Tel Raf/ Wire Shelf 4 Katlı / 4 Tiers, inox201 - 36*91*183 cm.
INT-YU0002	Tel Raf/ Wire Shelf 4 Katlı / 4 Tiers, inox201 - 36*107*183 cm.
INT-YU0007	Tel Raf/ Wire Shelf 4 Katlı / 4 Tiers, inox201 - 36*122*183 cm.
INT-YU0012	Tel Raf/ Wire Shelf 4 Katlı / 4 Tiers, inox201 - 36*137*183 cm.
INT-YU0017	Tel Raf/ Wire Shelf 4 Katlı / 4 Tiers, inox201 - 36*152*183 cm.
INT-YU0022	Tel Raf/ Wire Shelf 4 Katlı / 4 Tiers, inox201 - 36*183*183 cm.

**TEL İSTİF RAFLARI**  
**WIRE STORAGE SHELVES**

MODEL	EBATLAR / DIMENSIONS
	mm
INT-YU0078	Tel Raf/ Wire Shelf -4 Katlı / 4 Tiers- inox304-46*91*183
INT-YU0035	Tel Raf/ Wire Shelf -4 Katlı / 4 Tiers- inox304-46*107*183
INT-YU0043	Tel Raf/ Wire Shelf -4 Katlı / 4 Tiers- inox304-46*122*183
INT-YU0052	Tel Raf/ Wire Shelf -4 Katlı / 4 Tiers- inox304-46*137*183
INT-YU0061	Tel Raf/ Wire Shelf -4 Katlı / 4 Tiers- inox304-46*152*183
INT-YU0070	Tel Raf/ Wire Shelf -4 Katlı / 4 Tiers- inox304-46*183*183

**TEL İSTİF RAFLARI**  
**WIRE STORAGE SHELVES**

MODEL	EBATLAR / DIMENSIONS
mm	
INT-YU0075	Tel Raf/ Wire Shelf 4 Katlı / 4 Tiers, inox201 - 46*91*183
INT-YU0032	Tel Raf/ Wire Shelf 4 Katlı / 4 Tiers, inox201 - 46*107*183
INT-YU0040	Tel Raf/ Wire Shelf 4 Katlı / 4 Tiers, inox201 - 46*122*183
INT-YU0049	Tel Raf/ Wire Shelf 4 Katlı / 4 Tiers, inox201 - 46*137*183
INT-YU0058	Tel Raf/ Wire Shelf 4 Katlı / 4 Tiers, inox201 - 46*152*183
INT-YU0067	Tel Raf/ Wire Shelf 4 Katlı / 4 Tiers, inox201 - 46*183*183

**TEL İSTİF RAFLARI / PLASTİK**  
**WIRE STORAGE SHELVES / PLASTIC**

MODEL	EBATLAR / DIMENSIONS
mm	
INT-YU0077	Plastik Raf / Plastic Shelf , 4 Katlı / 4 Tiers 201 K. 46*91*183 cm.
INT-YU0034	Plastik Raf / Plastic Shelf , 4 Katlı / 4 Tiers 201 K. 46*107*183 cm.
INT-YU0042	Plastik Raf / Plastic Shelf , 4 Katlı / 4 Tiers 201 K. 46*122*183 cm.
INT-YU0051	Plastik Raf / Plastic Shelf , 4 Katlı / 4 Tiers 201 K. 46*137*183 cm.
INT-YU0060	Plastik Raf / Plastic Shelf , 4 Katlı / 4 Tiers 201 K. 46*152*183 cm.
INT-YU0069	Plastik Raf / Plastic Shelf , 4 Katlı / 4 Tiers 201 K. 46*183*183 cm.

**TEL İSTİF RAFLARI**  
**WIRE STORAGE SHELVES**

MODEL	EBATLAR / DIMENSIONS
mm	
INT-YU0133	Tel Raf/ Wire Shelf -4 Katlı / 4 Tiers- inox304-53*91*183
INT-YU0088	Tel Raf/ Wire Shelf -4 Katlı / 4 Tiers- inox304-53*107*183
INT-YU0097	Tel Raf/ Wire Shelf -4 Katlı / 4 Tiers- inox304-53*122*183
INT-YU0106	Tel Raf/ Wire Shelf -4 Katlı / 4 Tiers- inox304-53*137*183
INT-YU0114	Tel Raf/ Wire Shelf -4 Katlı / 4 Tiers- inox304-53*152*183
INT-YU0123	Tel Raf/ Wire Shelf -4 Katlı / 4 Tiers- inox304-53*183*183

**TEL İSTİF RAFLARI**  
**WIRE STORAGE SHELVES**

MODEL	EBATLAR / DIMENSIONS
	mm
INT-YU0130	Tel Raf/ Wire Shelf 4 Katlı / 4 Tiers, inox201 - 53*91*183
INT-YU0085	Tel Raf/ Wire Shelf 4 Katlı / 4 Tiers, inox201 - 53*107*183
INT-YU0094	Tel Raf/ Wire Shelf 4 Katlı / 4 Tiers, inox201 - 53*122*183
INT-YU0103	Tel Raf/ Wire Shelf 4 Katlı / 4 Tiers, inox201 - 53*137*183
INT-YU0111	Tel Raf/ Wire Shelf 4 Katlı / 4 Tiers, inox201 - 53*152*183
INT-YU0120	Tel Raf/ Wire Shelf 4 Katlı / 4 Tiers, inox201 - 53*183*183

**TEL İSTİF RAFLARI / PLASTİK**  
**WIRE STORAGE SHELVES / PLASTIC**

MODEL	EBATLAR / DIMENSIONS
	mm
INT-YU0132	Plastik Raf / Plastic Shelf, 4 Katlı / 4 Tiers, 201 K. 53*91*183 cm.
INT-YU0087	Plastik Raf / Plastic Shelf, 4 Katlı / 4 Tiers, 201 K. 53*107*183 cm.
INT-YU0096	Plastik Raf / Plastic Shelf, 4 Katlı / 4 Tiers., 201 K. 53*122*183 cm.
INT-YU0105	Plastik Raf / Plastic Shelf, 4 Katlı / 4 Tiers, 201 K. 53*137*183 cm.
INT-YU0113	Plastik Raf / Plastic Shelf, 4 Katlı / 4 Tiers, 201 K. 53*152*183 cm.
INT-YU0122	Plastik Raf / Plastic Shelf, 4 Katlı / 4 Tiers, 201 K. 53*183*183 cm.

**TEL İSTİF RAFLARI  
WIRE STORAGE SHELVES**

MODEL	EBATLAR / DIMENSIONS
	mm
INT-YU0179	Tel Raf/ Wire Shelf -4 Katlı / 4 Tiers- inox304-61*91*183
INT-YU0141	Tel Raf/ Wire Shelf -4 Katlı / 4 Tiers- inox304-61*107*183
INT-YU0149	Tel Raf/ Wire Shelf -4 Katlı / 4 Tiers- inox304-61*122*183
INT-YU0157	Tel Raf/ Wire Shelf -4 Katlı / 4 Tiers- inox304-61*137*183
INT-YU0164	Tel Raf/ Wire Shelf -4 Katlı / 4 Tiers- inox304-61*152*183
INT-YU0172	Tel Raf/ Wire Shelf -4 Katlı / 4 Tiers- inox304-61*183*183

**TEL İSTİF RAFLARI / Z01  
WIRE STORAGE SHELVES/ Z01**

MODEL	EBATLAR / DIMENSIONS
	mm
INT-YU0177	Tel Raf/ Wire Shelf 4 Katlı / 4 Tiers, inox201 - 61*91*183
INT-YU0139	Tel Raf/ Wire Shelf 4 Katlı / 4 Tiers, inox201 - 61*107*183
INT-YU0147	Tel Raf/ Wire Shelf 4 Katlı / 4 Tiers, inox201 - 61*122*183
INT-YU0155	Tel Raf/ Wire Shelf 4 Katlı / 4 Tiers, inox201 - 61*137*183
INT-YU0162	Tel Raf/ Wire Shelf 4 Katlı / 4 Tiers, inox201 - 61*152*183
INT-YU0170	Tel Raf/ Wire Shelf 4 Katlı / 4 Tiers, inox201 - 61*183*183

# MUTFAK DOLAPLARI

## KITCHEN CABINETS



- Tamamı AISI304 kalite 18/8 Cr-Ni paslanmaz çelikten üretilmiştir.
- Fonksiyonel tasarımı ile depolama ve kullanım kolaylığı sağlar.
- Kolay temizlenebilir, hijyenik ve ergonomik bir yapıya sahiptir.

- All devices and equipment are manufactured from AISI304 grade 18/8 Cr/Ni stainless steel.
- Wide selection of design and dimensions.
- Hygienic, ergonomic, convenient and easy to clean.

**INO-RDD**

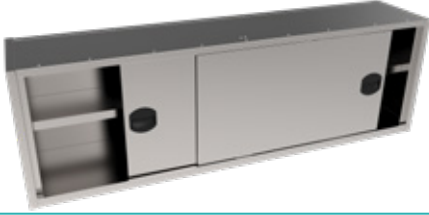

**DUVAR DOLABI**  
**WALL CUPBOARD**



MODEL	EBATLAR / DIMENSIONS
KAPILI / WITH DOOR	
	mm
INO-RDD 100	1000X400X600
INO-RDD 120	1200X400X600
INO-RDD 140	1400X400X600
INO-RDD 160	1600X400X600
INO-RDD 190	1900X400X600

**INO-RDA**



**DUVAR DOLABI**  
**WALL CUPBOARD**



MODEL	EBATLAR / DIMENSIONS
AÇIK / WITHOUT DOOR	
	mm
INO-RDA 100	1000X400X600
INO-RDA 120	1200X400X600
INO-RDA 140	1400X400X600
INO-RDA 160	1600X400X600
INO-RDA 190	1900X400X600

**INO-RED 126**



**EKMEK DOLABI**  
**BREAD CABINET**



MODEL	EBATLAR / DIMENSIONS
	mm
INO-RED 126	1200X600X1600

**INO-RMD 126**



**MALZEME DOLABI**  
**INGREDIENT CABINET**



MODEL	EBATLAR / DIMENSIONS
	mm
INO-RMD 126	1200X600X1600

**INO-RKD 095**



**KEPÇE, KEVGİR DOLABI**  
**UTENSIL CABINET**



MODEL	EBATLAR / DIMENSIONS
	mm
INO-RKD 095	900X500X1600



**INO-RBS 100-200**

**BIÇAK STERİLİZATÖRLERİ**  
**KNIFE STERILIZER**



MODEL	EBATLAR / DIMENSIONS
	mm
INO-RBS 100	575X100X480
INO-RBS 200	1030X150X480

# ASKI SİSTEMLERİ

.....

SUSPENSION SYSTEMS





## INO-REA

ET ASKI BORUSU  
MEAT HANGING PIPE

MODEL	EBATLAR / DIMENSIONS
	mm
INO-REA 100	1000
INO-REA 150	1500
INO-REA 200	2000



## INO-REH 120

ET ASKI SEHPASI  
MEAT HANGING UNIT

MODEL	EBATLAR / DIMENSIONS
	mm
INO-REH 120	1200X600X1750



## INO-RKA

KEPÇE ASKI BORUSU  
UTENSIL HANGING PIPE

MODEL	EBATLAR / DIMENSIONS
	mm
INO-RKA 100	1000
INO-RKA 150	1500
INO-RKA 200	2000

# RAFLAR

## SHELVES



- Tamamı AISI304 kalite 18/8 Cr-Ni paslanmaz çelik sac üretilmiştir.
- Süzme rafında süzme sacı 0.80 mm kalınlığında, taşıyıcı raf kısmı indirimli ve süzme işlemini sağlayacak şekilde perforeli, süzülen suyun tahliyesi için "Süzme rafı tahliyesi" takılı.
- Garnitür ünitesinin tamamı 1.20 mm AISI304 kalite 18/8 Cr-Ni paslanmaz çelik sactan mamül, duvara ya da tezgah üzerine monte edilebilir yapıdadır.

- All devices and equipment are manufactured from AISI304 grade 18/8 Cr/Ni stainless steel
- Draining shelves with perforated sheet which has 0,8 mm thickness.
- Sauce-salad unit is mountable on wall or table and has 1,2 mm thickness.

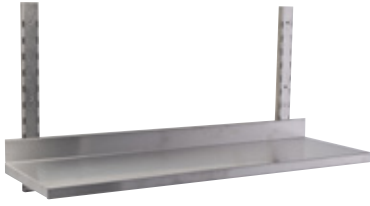

**INO-RRN**

**DUVAR RAFI DEMONTE  
WALL SHELF / DISASSEMBLED**

Tek Sıra / Single Tiers

MODEL	EBATLAR / DIMENSIONS
	mm
INO-RRN 063D	600X300X30
INO-RRN 073D	700X300X30
INO-RRN 083D	800X300X30
INO-RRN 093D	900X300X30
INO-RRN 103D	1000X300X30
INO-RRN 113D	1100X300X30
INO-RRN 123D	1200X300X30
INO-RRN 133D	1300X300X30
INO-RRN 143D	1400X300X30
INO-RRN 153D	1500X300X30
INO-RRN 163D	1600X300X30
INO-RRN 173D	1700X300X30
INO-RRN 183D	1800X300X30
INO-RRN 193D	1900X300X30
INO-RRN 203D	2000X300X30
INO-RRN 213D	2100X300X30
INO-RRN 223D	2200X300X30
INO-RRN 233D	2300X300X30
INO-RRN 243D	2400X300X30



**INO-RG2**

**GARNİTÜR ÜNİTESİ (GN 1/4 KAPLI)  
SPICE UNIT (GN 1/4)**

GN 1/4X100 mm Kaplı

MODEL	EBATLAR / DIMENSIONS
	mm
INO-RG 2014	400X300X200-2 ad. kap/ Pcs. Pans
INO-RG 3014	550X300X200-3 ad. kap/ Pcs. Pans
INO-RG 4014	700X300X200-4 ad. kap/ Pcs. Pans
INO-RG 5014	900X300X200-5 ad. kap/ Pcs. Pans

GN 1/6X100 mm Kaplı

MODEL	EBATLAR / DIMENSIONS
	mm
INO-RG 2016	400X210X160-2 ad. kap / Pcs. Pans
INO-RG 3016	550X210X160-3 ad. kap / Pcs. Pans
INO-RG 4016	700X210X160-4 ad. kap/ Pcs. Pans
INO-RG 5016	900X210X160-5 ad. kap/ Pcs. Pans

DEPOLAMA VE İSTİFLEME ÜNİTELERİ / RAFLAR  
STORAGE UNITS / SHELVES



**SÜZME RAFI  
WALL SHELF WITH DRAIN SHELF**

**INO-RRS**

MODEL	EBATLAR / DIMENSIONS
	mm
INO-RRS 083	800X300X30
INO-RRS 093	900X300X30
INO-RRS 103	1000X300X30
INO-RRS 113	1100X300X30
INO-RRS 123	1200X300X30
INO-RRS 133	1300X300X30
INO-RRS 143	1400X300X30
INO-RRS 153	1500X300X30
INO-RRS 163	1600X300X30
INO-RRS 173	1700X300X30
INO-RRS 183	1800X300X30
INO-RRS 193	1900X300X30
INO-RRS 203	2000X300X30
INO-RRS 213	2100X300X30
INO-RRS 223	2200X300X30
INO-RRS 233	2300X300X30
INO-RRS 243	2400X300X30

**INO-RRC**

**DUVAR RAFI DEMONTE  
WALL SHELF / DISASSEMBLED**

Çift Sıra / Double Tiers

MODEL	EBATLAR / DIMENSIONS
	mm
INO-RRC083D	800X300X500
INO-RRC093D	900X300X500
INO-RRC103D	1000X300X500
INO-RRC113D	1100X300X500
INO-RRC123D	1200X300X500
INO-RRC133D	1300X300X500
INO-RRC143D	1400X300X500
INO-RRC153D	1500X300X500
INO-RRC163D	1600X300X500
INO-RRC173D	1700X300X500
INO-RRC183D	1800X300X500
INO-RRC193D	1900X300X500
INO-RRC203D	2000X300X500
INO-RRC213D	2100X300X500
INO-RRC223D	2200X300X500
INO-RRC233D	2300X300X500
INO-RRC243D	2400X300X500

**INO-RRP**

**SALAMANDER/MİKRODALGA RAFI  
SHELF FOR SALAMANDER/MICROWAVE**

MODEL	EBATLAR / DIMENSIONS
	mm
INO-RRP 100	500x500x30
INO-RRP 200	700x500x30





**Soğutucular**

Cooling  
Equipments







### 2/1 - 1/1 Gn kap uygunluğu Available to use with GN 2/1 – 1/1



Raf sistemi 2/1 1/1 GN kaplara uygundur

Shelf storage system is available to use with GN 2/1 – 1/1



### 50 mm izolasyon kalınlığı 50 mm isolation



50 mm izolasyon kalınlığı olup, 45 Kg/m<sup>3</sup> Gazlı Çevre Dostu HCFC Free Poliüretan izolasyona sahiptir.

Bu özellik ile %20'lere varan enerji tasarrufu sağlanır.

With an insulation thickness of 50 mm, it has Environmental-Friendly HCFC-Free Polyurethane insulation with 45 kg/m<sup>3</sup> of gas. This feature provides less energy consumption up to 20%



### Paslanmaz Çelik Stainless Steel



Yalnızca gıda ile temas eden ve görünen yüzeyler paslanmaz çeliktir.

Only the visible surfaces and those in contact with food are stainless steel.



### Yüksekliği ayarlanabilir raf sistemi Adjustable shelving system



Ayarlanabilir raf sistemi

Provides effectiveness in adjusting height.



### Sökülebilir değiştirilebilir conta sistemi Removable gasket system



Manyetik yerinden sökülebilir kolay temizlenebilir conta sistemi

Removable and effaceable gasket system that can be removed magnetically.



### Modüler Çekmece Modular Drawers



İhtiyaca göre değiştirilebilir modüler çekmece sistemi

Removable and custom modular drawer system.



### Dijital Panel Digital Panel



Sensör arıza durumunda parametrelere bağlı olarak çalışma özelliği, HACCP özelliğine uygun.

Display screen indicate individual coding system regarding to each system failure.

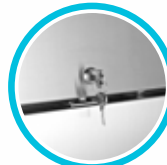

# STANDART SOĞUTUCULAR

## STANDARD COOLING EQUIPMENT



- Gıda ile temas eden ve görünen yüzeyler AISI 430 paslanmaz çeliktir.
  - 50 mm izolasyon kalınlığı olup, 45 Kg/m<sup>3</sup> Gazlı Çevre Dostu HCFC Free Poliüretan izolasyona sahiptir.
- Bu özellik ile %20'lere varan enerji tasarrufu sağlar.
- Fanlı soğutma sistemi vardır.
  - Digital termostat ve otomatik elektrik defrostludur.
  - Su buharlaşma sistemi sayesinde oluşan su; otomatik olarak havada buhar haline dönüşür ve kullanıcıyı gereksiz uğraştan kurtarır.
  - Raf sistemi 2/1 ve 1/1 GN kaplara uygundur ve ayarlanabilir.
  - Kapılar 135° sabit duran yaylı menteşe sistemine sahiptir.
  - Yüksekliği ayarlanabilir paslanmaz çelik ayaklara sahiptir.
  - 43° ve %60 bağıl nemde çalışır.
  - Manyetik, yerinden sökülebilir kolay temizlenebilir conta sistemi.
  - Sensör arıza durumunda parametrelere bağlı olarak çalışma özelliği ile gıdalarınızın bozulmasını önler.

- All parts in contact with food and other visible surfaces are made of AISI 430 S/S
- With an insulation thickness of 50 mm, it has Environmental-Friendly HCFC-Free Polyurethane insulation with 45 kg/m<sup>3</sup> of gas. This feature provides less energy consumption up to 20%.
- Ventilation cooling system.
- Digital thermostat and automatic hot gas defrosting.
- Evaporating of the water in the condenser thus overflowing will be avoided.
- Shelf system is available and regulatable for 2/1 and 1/1 GNs.
- 135 ° fixed spring hinge door system.
- Internal lighting, lockable door and adjustable stainless steel feet.
- Operated at 43 ° and 60% relative humidity.
- Magnetic, detachable and easy to clean gasket system.
- In case of failure of sensor or screen, working based on parameters to avoid deterioration of food.

**INO-SDN S**

 DEPO TİPİ BUZDOLABI  
 UPRIGHT REFRIGERATOR

MODEL	EBATLAR	İÇ SICAKLIK	KAPASİTE	GÜÇ	PAKET ÖLÇÜSÜ	AĞIRLIK
	DIMENSIONS	TEMPERATURE	CAPACITY	POWER	PACKING DIMENSIONS	WEIGHT
	mm	°C	Lt.	W	mm	Kg
INO-SDN 070 S	700x800x2100	-2 / +8	600	850	750x850x2250	140
INO-SDN 140 S	1400x800x2100	-2 / +8	1200	950	1450x850x2250	175

\* Tekerlek, cam kapı, ilave tel raf, opsiyoneldir.

\* Wheels, glass doors and wire shelves additional are optional.

**INO-SDF S**

 DEPO TİPİ DERİN DONDURUCU  
 UPRIGHT DEEP FREEZER

MODEL	EBATLAR	İÇ SICAKLIK	KAPASİTE	GÜÇ	PAKET ÖLÇÜSÜ	AĞIRLIK
	DIMENSIONS	TEMPERATURE	CAPACITY	POWER	PACKING DIMENSIONS	WEIGHT
	mm	°C	Lt.	W	mm	Kg
INO-SDF 070 S	700x800x2100	-18 / -20	600	1170	750x850x2250	140
INO-SDF 140 S	1400x800x2100	-18 / -20	1200	1650	1450x850x2250	175

\* Tekerlek, cam kapı, ilave tel raf, opsiyoneldir. Aydınlatma ve kilit sistemi opsiyoneldir.

\* Wheels, glass doors and wire shelves additional are optional. Lighting and lock system optional.

**INT-FR**

 DEPO TİPİ DERİN DONDURUCU  
 UPRIGHT DEEP FREEZER

MODEL	EBATLAR	İÇ SICAKLIK	KAPASİTE	GÜÇ	PAKET ÖLÇÜSÜ	AĞIRLIK
	DIMENSIONS	TEMPERATURE	CAPACITY	POWER	PACKING DIMENSIONS	WEIGHT
	mm	°C	Lt.	W	mm	Kg
INT-FR0696	1400x810x2050	-10/22	1400		1500x850x2200	231
INT-FR0697	700x810x2050	-10/22	700		800x850x2200	145
INT-FR0698	1400x810x2050	-2/+8	1400		1500x850x2200	217
INT-FR0699	700x810x2050	-2/+8	700		800x850x2200	138

**INO-SBN S**
**TEZGAH TİPİ BUZDOLABI**  
**COUNTER TYPE REFRIGERATOR / S/S TOP**

MODEL	EBATLAR	İÇ SICAKLIK	KAPASİTE	GÜÇ	PAKET ÖLÇÜSÜ	AĞIRLIK
	DIMENSIONS	TEMPERATURE	CAPACITY	POWER	PACKING DIMENSIONS	WEIGHT
	mm	°C	Lt.	W	mm	Kg
INO-SBN 146 S	1400x600x850	-2 / + 8	250	570	1450x650x1000	110
INO-SBN 196 S	1865x600x850	-2 / + 8	400	840	1900x650x1000	150
INO-SBN 246 S	2335x600x850	-2 / + 8	550	910	2400x650x1000	190
INO-SBN 140 S	1400x700x850	-2 / + 8	280	570	1450x750x1000	120
INO-SBN 190 S	1865x700x850	-2 / + 8	465	840	1900x750x1000	165
INO-SBN 240 S	2335x700x850	-2 / + 8	640	910	2400x750x1000	205

\* Aydınlatma, tekerlek, cam kapı, çekmece, ilave tel raf, kilit opsiyoneldir.  
 Lighting, wheels, glass door, drawer, wire shelf and lock additions are optional.

**INO-SBP S**
**TEZGAH TİPİ SOĞUTUCU / POLİETİLEN ÜST TABLALI**  
**COUNTER TYPE REFRIGERATOR / POLYETHYLENE TOP**

MODEL	EBATLAR	İÇ SICAKLIK	KAPASİTE	GÜÇ	PAKET ÖLÇÜSÜ	AĞIRLIK
	DIMENSIONS	TEMPERATURE	CAPACITY	POWER	PACKING DIMENSIONS	WEIGHT
	mm	°C	Lt.	W	mm	Kg
INO-SBP 146 S	1400x600x850	-2 / + 8	250	570	1450x650x1000	120
INO-SBP 196 S	1865x600x850	-2 / + 8	400	840	1900x650x1000	160
INO-SBP 246 S	2335x600x850	-2 / + 8	550	910	2400x650x1000	200
INO-SBP 140 S	1400x700x850	-2 / + 8	280	570	1450x750x1000	130
INO-SBP 190 S	1865x700x850	-2 / + 8	465	840	1900x750x1000	180
INO-SBP 240 S	2335x700x850	-2 / + 8	640	910	2400x750x1000	220

\* Aydınlatma, tekerlek, cam kapı, çekmece, ilave tel raf, kilit opsiyoneldir.  
 Lighting, wheels, glass door, drawer, wire shelf and lock additions are optional.



TEZGAH TİPİ BUZDOLABI  
COUNTER TYPE REFRIGERATOR / S/S TOP



## INT-FR

MODEL	EBATLAR	İÇ SICAKLIK	KAPASİTE	GÜÇ	PAKET ÖLÇÜSÜ	AĞIRLIK
	DIMENSIONS	TEMPERATURE	CAPACITY	POWER	PACKING DIMENSIONS	WEIGHT
	mm	°C	Lt.	W	mm	Kg
INT-FR0023	1400x700x850	-10/-20	281		1500x800x1000	145
INT-FR0027	1865x700x850	-10/-20	474		1970x800x1000	180
INT-FR0030	2330x700x850	-10/-20	632		2430x800x1000	210
INT-FR0131	1400x600x850	-10/-20	250		1500x700x1000	140
INT-FR0134	1865x700x850	-10/-20	474		1970x800x1000	180
INT-FR0137	2330x700x850	-10/-20	632		2430x800x1000	210

\* Aydınlatma, tekerlek, cam kapı, çekmece, ilave tel raf, kilit opsiyoneldir.  
Lighting, wheels, glass door, drawer, wire shelf and lock additions are optional.



SET ALTI TEZGAH TİPİ SOĞUTUCU  
UNDERCOUNTER REFRIGERATOR

## INO-SBS S

MODEL	EBATLAR	İÇ SICAKLIK	KAPASİTE	GÜÇ	PAKET ÖLÇÜSÜ	AĞIRLIK
	DIMENSIONS	TEMPERATURE	CAPACITY	POWER	PACKING DIMENSIONS	WEIGHT
	mm	°C	Lt.	W	mm	Kg
INO-SBS 166 S	1600x600x600	-2 / +8	120	570	1650x650x750	80
INO-SBS 206 S	2000x600x600	-2 / +8	190	570	2050x650x750	125
INO-SBS 160 S	1600x700x600	-2 / +8	140	570	1650x750x750	90
INO-SBS 200 S	2000x700x600	-2 / +8	230	570	2050x750x750	150



\* Aydınlatma, tekerlek, cam kapı, çekmece, ilave tel raf, kilit opsiyoneldir.  
Lighting, wheels, glass door, drawer, wire shelf and lock additions are optional.

**INO-SBM S**
**TEZGAH TİPİ SOĞUTUCU / MERMER ÜST TABLALI  
COUNTER TYPE REFRIGERATOR / MARBLE TOP**

MODEL	EBATLAR	İÇ SICAKLIK	KAPASİTE	GÜÇ	PAKET ÖLÇÜSÜ	AĞIRLIK
	DIMENSIONS	TEMPERATURE	CAPACITY	POWER	PACKING DIMENSIONS	WEIGHT
	mm	°C	Lt.	W	mm	Kg
INO-SBM 146 S	1400x600x850	-2 / + 8	250	570	1450x650x1000	170
INO-SBM 196 S	1865x600x850	-2 / + 8	400	840	1900x650x1000	210
INO-SBM 246 S	2335x600x850	-2 / + 8	550	910	2400x650x1000	250
INO-SBM 140 S	1400x700x850	-2 / + 8	280	570	1450x750x1000	180
INO-SBM 190 S	1865x700x850	-2 / + 8	465	840	1900x750x1000	220
INO-SBM 240 S	2335x700x850	-2 / + 8	640	910	2400x750x1000	245

\* Aydınlatma, tekerlek, cam kapı, çekmece, ilave tel raf, kilit opsiyoneldir.

Lighting, wheels, glass door, drawer, wire shelf and lock additions are optional.

**INO-SBE S**
**TEZGAH TİPİ SOĞUTUCU / EVİYE ÜST TABLALI  
COUNTER TYPE REFRIGERATOR / WITH SINK**

MODEL	EBATLAR	İÇ SICAKLIK	KAPASİTE	GÜÇ	PAKET ÖLÇÜSÜ	AĞIRLIK
	DIMENSIONS	TEMPERATURE	CAPACITY	POWER	PACKING DIMENSIONS	WEIGHT
	mm	°C	Lt.	W	mm	Kg
INO-SBE 146 S	1400x600x850	-2 / + 8	250	570	1450x650x1000	110
INO-SBE 196 S	1865x600x850	-2 / + 8	400	840	1900x650x1000	150
INO-SBE 246 S	2335x600x850	-2 / + 8	550	910	2400x650x1000	190
INO-SBE 140 S	1400x700x850	-2 / + 8	280	570	1450x750x1000	120
INO-SBE 190 S	1865x700x850	-2 / + 8	465	840	1900x750x1000	165
INO-SBE 240 S	2335x700x850	-2 / + 8	640	910	2400x750x1000	205

\* Aydınlatma, tekerlek, cam kapı, çekmece, ilave tel raf, kilit opsiyoneldir.

\* Evye ölçüsü 350x400x250mm dir. / 350\*400\*250mm sink

Lighting, wheels, glass door, drawer, wire shelf and lock additions are optional.

**GN KAP KAPASİTESİ  
GN CAPACITY**

1400mm'de =1/4-100 7 adet Gn küvet kapasiteli  
1865mm'de =1/4-100 10 adet Gn küvet kapasiteli  
2335mm'de =1/4-100 13 adet Gn küvet kapasiteli

1400mm=1/4-100 7 pcs Gn bin cap.  
1865mm=1/4-100 10 pcs Gn bin cap.  
2335mm=1/4-100 13 pcs Gn bin cap.

**INO-SGN S**
**PİZZA HAZIRLIK ÜNİTESİ / PASLANMAZ TABLALI  
PIZZA PREPARATION UNIT / S/S TOP**

MODEL	EBATLAR	İÇ SICAKLIK	KAPASİTE	GÜÇ	PAKET ÖLÇÜSÜ	AĞIRLIK
	DIMENSIONS	TEMPERATURE	CAPACITY	POWER	PACKING DIMENSIONS	WEIGHT
	mm	°C	Lt.	W	mm	Kg
INO-SGN 140 S	1400x700x1300	-2 / + 8	280	840	1450x750x1500	165
INO-SGN 190 S	1865x700x1300	-2 / + 8	465	840	1900x750x1500	205
INO-SGN 240 S	2335x700x1300	-2 / + 8	640	910	2400x750x1500	230



\* Aydınlatma, tekerlek, cam kapı, çekmece, ilave tel raf, kilit opsiyoneldir. \*GN kaplar fiyata dahil değildir.

Lighting, wheels, glass door, drawer, wire shelf and lock additions are optional. GN CONTAINERS ARE NOT INCLUDED

**GN KAP KAPASİTESİ  
GN CAPACITY**

1400mm'de =1/4-100 7 adet GN küvet kapasiteli  
1865mm'de =1/4-100 10 adet GN küvet kapasiteli  
2335mm'de =1/4-100 13 adet GN küvet kapasiteli

1400mm=1/4-100 7 pcs GN bin cap.  
1865mm=1/4-100 10 pcs GN bin cap.  
2335mm=1/4-100 13 pcs GN bin cap.

**PİZZA HAZIRLIK ÜNİTESİ / POLİETİLEN TABLALI  
PIZZA PREPARATION UNIT / POLYETHYLENE TOP**

**SGP S**

MODEL	EBATLAR	İÇ SICAKLIK	KAPASİTE	GÜÇ	PAKET ÖLÇÜSÜ	AĞIRLIK
	DIMENSIONS	TEMPERATURE	CAPACITY	POWER	PACKING DIMENSIONS	WEIGHT
	mm	°C	Lt.	W	mm	Kg
INO-SGP 140 S	1400x700x1300	-2 / + 8	280	840	1450x750x1500	175
INO-SGP 190 S	1865x700x1300	-2 / + 8	465	840	1900x750x1500	220
INO-SGP 240 S	2335x700x1300	-2 / + 8	640	910	2400x750x1500	240

\* Aydınlatma, tekerlek, cam kapı, çekmece, ilave tel raf, kilit opsiyoneldir. \*GN kaplar fiyata dahil değildir.

Lighting, wheels, glass door, drawer, wire shelf and lock additions are optional. GN CONTAINERS ARE NOT INCLUDED

**GN KAP KAPASİTESİ  
GN CAPACITY**

1400mm'de =1/4-100 7 adet GN küvet kapasiteli  
1865mm'de =1/4-100 10 adet GN küvet kapasiteli  
2335mm'de =1/4-100 13 adet GN küvet kapasiteli

1400mm=1/4-100 7 pcs GN bin cap.  
1865mm=1/4-100 10 pcs GN bin cap.  
2335mm=1/4-100 13 pcs GN bin cap.

**SOĞUTUCULAR / STANDART SOĞUTUCULAR  
COOLING / STANDARD COOLING EQUIPMENT**

**SGM S**

MODEL	EBATLAR	İÇ SICAKLIK	KAPASİTE	GÜÇ	PAKET ÖLÇÜSÜ	AĞIRLIK
	DIMENSIONS	TEMPERATURE	CAPACITY	POWER	PACKING DIMENSIONS	WEIGHT
	mm	°C	Lt.	W	mm	Kg
INO-SGM 140 S	1400x700x1300	-2 / + 8	280	840	1450x750x1500	220
INO-SGM 190 S	1865x700x1300	-2 / + 8	465	840	1900x750x1500	260
INO-SGM 240 S	2335x700x1300	-2 / + 8	640	910	2400x750x1500	300

\* Aydınlatma, tekerlek, cam kapı, çekmece, ilave tel raf, kilit opsiyoneldir. \*GN kaplar fiyata dahil değildir.

Lighting, wheels, glass door, drawer, wire shelf and lock additions are optional. GN CONTAINERS ARE NOT INCLUDED

**SGT S**
**GN KAP KAPASİTESİ  
GN CAPACITY**

1400mm'de =1/4-100 7 adet Gn küvet kapasiteli  
1865mm'de =1/4-100 10 adet Gn küvet kapasiteli  
2335mm'de =1/4-100 13 adet Gn küvet kapasiteli

1400mm=1/4-100 7 pcs GN bin cap.  
1865mm=1/4-100 10 pcs GN bin cap.  
2335mm=1/4-100 13 pcs GN bin cap.

**PİZZA HAZIRLIK ÜNİTESİ / TABLA ÜSTÜ GARNİTÜR ÜNİTESİ  
PIZZA PREPARATION UNIT / S/S TOP GARNITURE UNIT**

MODEL	EBATLAR	İÇ SICAKLIK	KAPASİTE	GÜÇ	PAKET ÖLÇÜSÜ	AĞIRLIK
	DIMENSIONS	TEMPERATURE	CAPACITY	POWER	PACKING DIMENSIONS	WEIGHT
	mm	°C	Lt.	W	mm	Kg
INO-SGT 140 S	1400x700x1050	-2 / + 8	280	840	1450x750x1250	150
INO-SGT 190 S	1865x700x1050	-2 / + 8	465	840	1900x750x1250	190
INO-SGT 240 S	2335x700x1050	-2 / + 8	640	910	2400x750x1250	215

\* Aydınlatma, tekerlek, cam kapı, çekmece, ilave tel raf, kilit opsiyoneldir. \*GN kaplar fiyata dahil değildir.

\* Wheels, glass door, drawers, lock and wire shelf additional are optional. GN CONTAINERS ARE NOT INCLUDED

**SGB S**
**GN KAP KAPASİTESİ  
GN CAPACITY**

1400mm'de =1/4-100 7 adet Gn küvet kapasiteli  
1865mm'de =1/4-100 10 adet Gn küvet kapasiteli  
2335mm'de =1/4-100 13 adet Gn küvet kapasiteli

1400mm=1/4-100 7 pcs GN bin cap.  
1865mm=1/4-100 10 pcs GN bin cap.  
2335mm=1/4-100 13 pcs GN bin cap.

**PİZZA HAZIRLIK ÜNİTESİ - BORU AYAKLI  
PIZZA PREPARATION UNIT / S/S TOP / ELEVATED GARNITURE UNIT**

MODEL	EBATLAR	İÇ SICAKLIK	KAPASİTE	GÜÇ	PAKET ÖLÇÜSÜ	AĞIRLIK
	DIMENSIONS	TEMPERATURE	CAPACITY	POWER	PACKING DIMENSIONS	WEIGHT
	mm	°C	Lt.	W	mm	Kg
INO-SGB 140 S	1400x700x1300	-2 / + 8	280	840	1450x750x1500	170
INO-SGB 190 S	1865x700x1300	-2 / + 8	465	840	1900x750x1500	215
INO-SGB 240 S	2335x700x1300	-2 / + 8	640	910	2400x750x1500	235

\* Aydınlatma, tekerlek, cam kapı, çekmece, ilave tel raf, kilit opsiyoneldir. \*GN kaplar fiyata dahil değildir.

\* Wheels, glass door, drawers, lock and wire shelf additional are optional. GN CONTAINERS ARE NOT INCLUDED



1/2



2/3



1/3

**İLAVELER  
ADDITIONAL ITEMS**

MODEL	AÇIKLAMA / FEATURES
2047000200	ÇEKMECE FARKI, 700mm Tezgah Tipi Buzdolabı için 1/2 / Drawer for 700mm depth counter type refrigerator, 1/2
2047000210	ÇEKMECE FARKI, 700mm Tezgah Tipi Buzdolabı için 1/3 / Drawer for 700mm depth counter type refrigerator, 1/3
2047000220	ÇEKMECE FARKI, 700mm Tezgah Tipi Buzdolabı için 2/3 / Drawer for 700mm depth counter type refrigerator, 2/3
2047000201	ÇEKMECE FARKI, 600mm Tezgah Tipi Buzdolabı için 1/2 / Drawer for 600mm depth counter type refrigerator, 1/2
2047000211	ÇEKMECE FARKI, 600mm Tezgah Tipi Buzdolabı için 1/3 / Drawer for 600mm depth counter type refrigerator, 1/3
2047000221	ÇEKMECE FARKI, 600mm Tezgah Tipi Buzdolabı için 2/3 / Drawer for 600mm depth counter type refrigerator, 2/3

MODEL	AÇIKLAMA / FEATURES
2047000250	CAM KAPI FARKI, Tezgah Tipi Buzdolabı için, alüminyum çerçeveli / Glass door for counter refrigerator, aluminium frame
2047000251	CAM KAPI FARKI, Tezgah Tipi Buzdolabı için, paslanmaz çerçeveli sol / Glass door for counter refrigerator, s/s frame, left
2047000252	CAM KAPI FARKI, Tezgah Tipi Buzdolabı için, paslanmaz çerçeveli sağ / Glass door for counter refrigerator, s/s frame, right
2047000260	CAM KAPI FARKI, Depo Tipi Buzdolabı için, alüminyum çerçeveli / Glass door for upright refrigerator, aluminium frame
2047000261	CAM KAPI FARKI, Depo Tipi Buzdolabı için, paslanmaz çerçeveli / Glass door for upright refrigerator, s/s frame



İLAVELER  
ADDITIONAL ITEMS

MODEL	AÇIKLAMA / FEATURES
2047000240	ÇEKMECE FARKI, 700mm Set Altı Buzdolabı için 1/1 / Drawer for 700mm depth U/C refrigerator 1/1.
2047000241	ÇEKMECE FARKI, 600mm Set Altı Buzdolabı için 1/1 / Drawer for 600mm depth U/C refrigerator 1/1.
2047030770	ÇEKMECE FARKI, 700 mm Set Altı Buzdolabı için 1/1 / Drawer for 700mm depth U/C refrigerator,1/1.
2047030800	ÇEKMECE FARKI, 600 mm Set Altı Buzdolabı için 1/1 / Drawer for 600mm depth U/C refrigerator, 1/1.

# PREMIUM SERİ SOĞUTUCULAR

PREMIUM  
COOLING  
EQUIPMENTS



- Gıda ile temas eden ve görünen yüzeyler AISI 304 paslanmaz çeliktir.
- 50 mm izolasyon kalınlığı olup, 45 Kg/m<sup>3</sup> Gazlı Çevre Dostu HCFC Free Poliüretan izolasyona sahiptir.
- Bu özellik ile %20'lere varan enerji tasarrufu sağlar.
- Fanlı soğutma sistemi vardır.
- Digital termostat ve otomatik elektrik defrostludur.
- Su buharlaşma sistemi sayesinde oluşan su; otomatik olarak havada buhar haline dönüşür ve kullanıcıyı gereksiz uğraştan kurtarır.
- Raf sistemi 2/1 ve 1/1 GN kaplara uygundur ve ayarlanabilir.
- Kapılar 135° sabit duran yaylı menteşe sistemine sahiptir.
- İç aydınlatmalı, kapılar kilitlenebilir ve yüksekliği ayarlanabilir paslanmaz çelik ayaklara sahiptir.
- 43° ve %60 bağıl nemde çalışır.
- Manyetik, yerinden sökülebilir kolay temizlenebilir conta sistemi.
- Sensör arıza durumunda parametrelere bağlı olarak çalışma özelliği ile gıdalarınızın bozulmasını önler.

- All parts in contact with food and other visible surfaces are made of AISI 304 S/S
- With an insulation thickness of 50 mm, it has Environmental-Friendly HCFC-Free Polyurethane insulation with 45 kg/m<sup>3</sup> of gas. This feature provides less energy consumption up to 20%.
- Ventilation cooling system.
- Digital thermostat and automatic hot gas defrosting.
- Evaporating of the water in the condenser thus overflowing will be avoided.
- Shelf system is available and regulatable for 2/1 and 1/1 GNs.
- 135 ° fixed spring hinge door system.
- Internal lighting, lockable door and adjustable stainless steel feet.
- Operated at 43 ° and 60% relative humidity.
- Magnetic, detachable and easy to clean gasket system.
- In case of failure of sensor or screen, working based on parameters to avoid deterioration of food.

**DEPO TİPİ BUZDOLABI**  
**UPRIGHT REFRIGERATOR**
**SDN**

MODEL	EBATLAR	İÇ SICAKLIK	KAPASİTE	GÜÇ	PAKET ÖLÇÜSÜ	AĞIRLIK
	DIMENSIONS	TEMPERATURE	CAPACITY	POWER	PACKING DIMENSIONS	WEIGHT
	mm	°C	Lt.	W	mm	Kg
INO-SDN 070	700x800x2100	-2 / +8	600	850	750x850x2250	140
INO-SDN 140	1400x800x2100	-2 / +8	1200	950	1450x850x2250	175

\* HACCP özelliği fiyata dahildir. \* Tekerlek, cam kapı, ilave tel raf, opsiyoneldir.

\* Wheels, glass doors and wire shelves additional are optional.

**DEPO TİPİ DERİN DONDURUCU**  
**UPRIGHT DEEP FREEZER**
**SDF**

MODEL	EBATLAR	İÇ SICAKLIK	KAPASİTE	GÜÇ	PAKET ÖLÇÜSÜ	AĞIRLIK
	DIMENSIONS	TEMPERATURE	CAPACITY	POWER	PACKING DIMENSIONS	WEIGHT
	mm	°C	Lt.	W	mm	Kg
INO-SDF 070	700x800x2100	-18 / -20	600	1170	750x850x2250	140
INO-SDF 140	1400x800x2100	-18 / -20	1200	1650	1450x850x2250	175

\* HACCP özelliği fiyata dahildir. \* Tekerlek, cam kapı, ilave tel raf, opsiyoneldir.

\* Wheels, glass doors and wire shelves additional are optional.

**DEPO TİPİ DERİN DONDURUCU**  
**UPRIGHT DEEP FREEZER**
**INT-FR**

MODEL	EBATLAR	İÇ SICAKLIK	KAPASİTE	GÜÇ	PAKET ÖLÇÜSÜ	AĞIRLIK
	DIMENSIONS	TEMPERATURE	CAPACITY	POWER	PACKING DIMENSIONS	WEIGHT
	mm	°C	Lt.	W	mm	Kg
INT-FR0475	1400x810x2050	-10/22	1400		1500x850x2200	231
INT-FR0489	700x810x2050	-10/22	700		800x850x2200	145
INT-FR0513	1400x810x2050	-2/+8	1400		1500x850x2200	217
INT-FR0534	700x810x2050	-2/+8	700		800x850x2200	138

**SBN**
**TEZGAH TİPİ BUZDOLABI**  
**COUNTER TYPE REFRIGERATOR / S/S TOP**

MODEL	EBATLAR	İÇ SICAKLIK	KAPASİTE	GÜÇ	PAKET ÖLÇÜSÜ	AĞIRLIK
	DIMENSIONS	TEMPERATURE	CAPACITY	POWER	PACKING DIMENSIONS	WEIGHT
	mm	°C	Lt.	W	mm	Kg
INO-SBN 146	1400x600x850	-2 / + 8	250	570	1450x650x1000	110
INO-SBN 196	1865x600x850	-2 / + 8	400	840	1900x650x1000	150
INO-SBN 246	2335x600x850	-2 / + 8	550	910	2400x650x1000	190
INO-SBN 140	1400x700x850	-2 / + 8	280	570	1450x750x1000	120
INO-SBN 190	1865x700x850	-2 / + 8	465	840	1900x750x1000	165
INO-SBN 240	2335x700x850	-2 / + 8	640	910	2400x750x1000	205

\* HACCP özelliği fiyata dahildir. \* Aydınlatma, tekerlek, cam kapı, çekmece, ilave tel raf, kilit opsiyoneldir.

Lighting, wheels, glass door, drawer, wire shelf and lock additions are optional.

**SBP**
**TEZGAH TİPİ SOĞUTUCU / POLİETİLEN ÜST TABLALI**  
**COUNTER TYPE REFRIGERATOR / POLYETHYLENE TOP**

MODEL	EBATLAR	İÇ SICAKLIK	KAPASİTE	GÜÇ	PAKET ÖLÇÜSÜ	AĞIRLIK
	DIMENSIONS	TEMPERATURE	CAPACITY	POWER	PACKING DIMENSIONS	WEIGHT
	mm	°C	Lt.	W	mm	Kg
INO-SBP 146	1400x600x850	-2 / + 8	250	570	1450x650x1000	120
INO-SBP 196	1865x600x850	-2 / + 8	400	840	1900x650x1000	160
INO-SBP 246	2335x600x850	-2 / + 8	550	910	2400x650x1000	200
INO-SBP 140	1400x700x850	-2 / + 8	280	570	1450x750x1000	130
INO-SBP 190	1865x700x850	-2 / + 8	465	840	1900x750x1000	180
INO-SBP 240	2335x700x850	-2 / + 8	640	910	2400x750x1000	220

\* HACCP özelliği fiyata dahildir. \* Aydınlatma, tekerlek, cam kapı, çekmece, ilave tel raf, kilit opsiyoneldir.

Lighting, wheels, glass door, drawer, wire shelf and lock additions are optional.

**FİYAT İSTEYİNİZ**



TEZGAH TİPİ BUZDOLABI  
COUNTER TYPE REFRIGERATOR / S/S TOP



## INT-FR

MODEL	EBATLAR	İÇ SICAKLIK	KAPASİTE	GÜÇ	PAKET ÖLÇÜSÜ	AĞIRLIK
	DIMENSIONS	TEMPERATURE	CAPACITY	POWER	PACKING DIMENSIONS	WEIGHT
	mm	°C	Lt.	W	mm	Kg
INT-FR0166	1400x700x850	-10/-20	281		1500x800x1000	145
INT-FR0170	1865x700x850	-10/-20	474		1970x800x1000	180
INT-FR0175	2330x700x850	-10/-20	632		2430x800x1000	210
INT-FR0254	1400x600x850	-10/-20	250		1500x700x1000	140
INT-FR0257	1865x600x850	-10/-20	400		1970x700x1000	175
INT-FR0260	2330x600x850	-10/-20	550		2430x700x1000	205

\* Aydınlatma, tekerlek, cam kapı, çekmece, ilave tel raf, kilit opsiyoneldir.  
Lighting, wheels, glass door, drawer, wire shelf and lock additions are optional.

**SBM**
**TEZGAH TİPİ SOĞUTUCU / MERMER ÜST TABLALI**  
**COUNTER TYPE REFRIGERATOR / MARBLE TOP**

MODEL	EBATLAR	İÇ SICAKLIK	KAPASİTE	GÜÇ	PAKET ÖLÇÜSÜ	AĞIRLIK
	DIMENSIONS	TEMPERATURE	CAPACITY	POWER	PACKING DIMENSIONS	WEIGHT
	mm	C	Lt.	W	mm	Kg
INO-SBM 146	1400x600x850	-2 / +8	250	570	1450x650x1000	170
INO-SBM 196	1865x600x850	-2 / +8	400	840	1900x650x1000	210
INO-SBM 246	2335x600x850	-2 / +8	550	910	2400x650x1000	250
INO-SBM 140	1400x700x850	-2 / +8	280	570	1450x750x1000	180
INO-SBM 190	1865x700x850	-2 / +8	465	840	1900x750x1000	220
INO-SBM 240	2335x700x850	-2 / +8	640	910	2400x750x1000	245

\* HACCP özelliği fiyata dahildir. \* Aydınlatma, tekerlek, cam kapı, çekmece, ilave tel raf, kilit opsiyoneldir.

Lighting, wheels, glass door, drawer, wire shelf and lock additions are optional.

**SBE**
**TEZGAH TİPİ SOĞUTUCU / EVİYE ÜST TABLALI**  
**COUNTER TYPE REFRIGERATOR / WITH SINK**

MODEL	EBATLAR	İÇ SICAKLIK	KAPASİTE	GÜÇ	PAKET ÖLÇÜSÜ	AĞIRLIK
	DIMENSIONS	TEMPERATURE	CAPACITY	POWER	PACKING DIMENSIONS	WEIGHT
	mm	C	Lt.	W	mm	Kg
INO-SBE 146	1400x600x850	-2 / +8	250	570	1450x650x1000	110
INO-SBE 196	1865x600x850	-2 / +8	400	840	1900x650x1000	150
INO-SBE 246	2335x600x850	-2 / +8	550	910	2400x650x1000	190
INO-SBE 140	1400x700x850	-2 / +8	280	570	1450x750x1000	120
INO-SBE 190	1865x700x850	-2 / +8	465	840	1900x750x1000	165
INO-SBE 240	2335x700x850	-2 / +8	640	910	2400x750x1000	205

\* HACCP özelliği fiyata dahildir. \* Aydınlatma, tekerlek, cam kapı, çekmece, ilave tel raf, kilit opsiyoneldir.

\* Evye ölçüsü / Sink Unit Dimension 350x400x250 mm'dir.

Lighting, wheels, glass door, drawer, wire shelf and lock additions are optional.

**FİYAT İSTEYİNİZ**

**SBF**
**TEZGAH TİPİ DERİN DONDURUCU  
COUNTER TYPE FREEZER**

MODEL	EBATLAR	İÇ SICAKLIK	KAPASİTE	GÜÇ	PAKET ÖLÇÜSÜ	AĞIRLIK
	DIMENSIONS	TEMPERATURE	CAPACITY	POWER	PACKING DIMENSIONS	WEIGHT
	mm	°C	Lt.	W	mm	Kg
INO-SBF 146	1400x600x850	-18 / -20	250	570	1450x650x1000	110
INO-SBF 196	1865x600x850	-18 / -20	400	840	1900x650x1000	150
INO-SBF 140	1400x700x850	-18 / -20	280	570	1450x750x1000	120
INO-SBF 190	1865x700x850	-18 / -20	465	1100	1900x750x1000	165

\* HACCP özelliği fiyata dahildir. \* Aydınlatma, tekerlek, cam kapı, çekmece, ilave tel raf, kilit opsiyoneldir.  
Lighting, wheels, glass door, drawer, wire shelf and lock additions are optional.

**SET ALTI TEZGAH TİPİ SOĞUTUCU**  
**UNDERCOUNTER REFRIGERATOR**

**SBS**

MODEL	EBATLAR	İÇ SICAKLIK	KAPASİTE	GÜÇ	PAKET ÖLÇÜSÜ	AĞIRLIK
	DIMENSIONS	TEMPERATURE	CAPACITY	POWER	PACKING DIMENSIONS	WEIGHT
	mm	°C	Lt.	W	mm	Kg
INO-SBS 166	1600x600x600	-2 / +8	120	570	1650x650x750	80
INO-SBS 206	2000x600x600	-2 / +8	190	570	2050x650x750	125
INO-SBS 160	1600x700x600	-2 / +8	140	570	1650x750x750	90
INO-SBS 200	2000x700x600	-2 / +8	230	570	2050x750x750	150

\* HACCP özelliği fiyata dahildir. \* Aydınlatma, tekerlek, cam kapı, çekmece, ilave tel raf, kilit opsiyoneldir.  
 Lighting, wheels, glass door, drawer, wire shelf and lock additions are optional.

**GN KAP KAPASİTESİ**  
**GN CAPACITY**

1400mm'de =1/4-100 7 adet Gn küvet kapasiteli  
 1865mm'de =1/4-100 10 adet Gn küvet kapasiteli  
 2335mm'de =1/4-100 13 adet Gn küvet kapasiteli

1400mm=1/4-100 7 pcs GN bin cap.  
 1865mm=1/4-100 10 pcs GN bin cap.  
 2335mm=1/4-100 13 pcs GN bin cap.

**PİZZA HAZIRLIK ÜNİTESİ / PASLANMAZ TABLALI**  
**PIZZA PREPARATION UNIT / S/S TOP**

**SGN**

MODEL	EBATLAR	İÇ SICAKLIK	KAPASİTE	GÜÇ	PAKET ÖLÇÜSÜ	AĞIRLIK
	DIMENSIONS	TEMPERATURE	CAPACITY	POWER	PACKING DIMENSIONS	WEIGHT
	mm	°C	Lt.	W	mm	Kg
INO-SGN 140	1400x700x1300	-2 / +8	280	840	1450x750x1500	165
INO-SGN 190	1865x700x1300	-2 / +8	465	840	1900x750x1500	205
INO-SGN 240	2335x700x1300	-2 / +8	640	910	2400x750x1500	230

\* HACCP özelliği fiyata dahildir. \* Aydınlatma, tekerlek, cam kapı, çekmece, ilave tel raf, kilit opsiyoneldir. \*GN kaplar fiyata dahil değildir.  
 Lighting, wheels, glass door, drawer, wire shelf and lock additions are optional. GN CONTAINERS ARE NOT INCLUDED.

**SGP**
**GN KAP KAPASİTESİ  
GN CAPACITY**

1400mm'de =1/4-100 7 adet Gn kuvet kapasiteli  
1865mm'de =1/4-100 10 adet Gn kuvet kapasiteli  
2335mm'de =1/4-100 13 adet Gn kuvet kapasiteli

1400mm=1/4-100 7 pcs GN bin cap.  
1865mm=1/4-100 10 pcs GN bin cap.  
2335mm=1/4-100 13 pcs GN bin cap.

**PİZZA HAZIRLIK ÜNİTESİ / POLİETİLEN TABLALI  
PIZZA PREPARATION UNIT / POLYETHYLENE TOP**

MODEL	EBATLAR	İÇ SICAKLIK	KAPASİTE	GÜÇ	PAKET ÖLÇÜSÜ	AĞIRLIK
	DIMENSIONS	TEMPERATURE	CAPACITY	POWER	PACKING DIMENSIONS	WEIGHT
	mm	°C	Lt.	W	mm	Kg
INO-SGP 140	1400x700x1300	-2 / + 8	280	840	1450x750x1500	175
INO-SGP 190	1865x700x1300	-2 / + 8	465	840	1900x750x1500	220
INO-SGP 240	2335x700x1300	-2 / + 8	640	910	2400x750x1500	240

\* HACCP özelliği fiyata dahildir. \* Aydınlatma, tekerlek, cam kapı, çekmece, ilave tel raf, kilit opsiyoneldir. \*GN kaplar fiyata dahil değildir.  
Lighting, wheels, glass door, drawer, wire shelf and lock additions are optional. GN CONTAINERS ARE NOT INCLUDED.

**SGM**
**GN KAP KAPASİTESİ  
GN CAPACITY**

1400mm'de =1/4-100 7 adet Gn kuvet kapasiteli  
1865mm'de =1/4-100 10 adet Gn kuvet kapasiteli  
2335mm'de =1/4-100 13 adet Gn kuvet kapasiteli

1400mm=1/4-100 7 pcs GN bin cap.  
1865mm=1/4-100 10 pcs GN bin cap.  
2335mm=1/4-100 13 pcs GN bin cap.

**PİZZA HAZIRLIK ÜNİTESİ / MERMER TABLALI  
PIZZA PREPARATION UNIT / MARBLE TOP**

MODEL	EBATLAR	İÇ SICAKLIK	KAPASİTE	GÜÇ	PAKET ÖLÇÜSÜ	AĞIRLIK
	DIMENSIONS	TEMPERATURE	CAPACITY	POWER	PACKING DIMENSIONS	WEIGHT
	mm	°C	Lt.	W	mm	Kg
INO-SGM 140	1400x700x1300	-2 / + 8	280	840	1450x750x1500	220
INO-SGM 190	1865x700x1300	-2 / + 8	465	840	1900x750x1500	260
INO-SGM 240	2335x700x1300	-2 / + 8	640	910	2400x750x1500	300

\* HACCP özelliği fiyata dahildir. \* Aydınlatma, tekerlek, cam kapı, çekmece, ilave tel raf, kilit opsiyoneldir. \*GN kaplar fiyata dahil değildir.  
Lighting, wheels, glass door, drawer, wire shelf and lock additions are optional. GN CONTAINERS ARE NOT INCLUDED.

**GN KAP KAPASİTESİ  
GN CAPACITY**

1400mm'de =1/4-100 7 adet Gn küvet kapasiteli  
1865mm'de =1/4-100 10 adet Gn küvet kapasiteli  
2335mm'de =1/4-100 13 adet Gn küvet kapasiteli

1400mm=1/4-100 7 pcs GN bin cap.  
1865mm=1/4-100 10 pcs GN bin cap.  
2335mm=1/4-100 13 pcs GN bin cap.

**PIZZA HAZIRLIK ÜNİTESİ / TABLA ÜSTÜ GARNİTÜR ÜNİTESİ  
PIZZA PREPARATION UNIT / S/S TOP GARNITURE UNIT**

**SGT**

MODEL	EBATLAR	İÇ SICAKLIK	KAPASİTE	GÜÇ	PAKET ÖLÇÜSÜ	AĞIRLIK
	DIMENSIONS	TEMPERATURE	CAPACITY	POWER	PACKING DIMENSIONS	WEIGHT
	mm	°C	Lt.	W	mm	Kg
INO-SGT 140	1400x700x1050	-2 / + 8	280	840	1450x750x1250	150
INO-SGT 190	1865x700x1050	-2 / + 8	465	840	1900x750x1250	190
INO-SGT 240	2335x700x1050	-2 / + 8	640	910	2400x750x1250	215

\* HACCP özelliği fiyata dahildir. \* Aydınlatma, tekerlek, cam kapı, çekmece, ilave tel raf, kilit opsiyoneldir. \*GN kaplar fiyata dahil değildir.  
Lighting, wheels, glass door, drawer, wire shelf and lock additions are optional. GN CONTAINERS ARE NOT INCLUDED.

**GN KAP KAPASİTESİ  
GN CAPACITY**

1400mm'de =1/4-100 7 adet Gn küvet kapasiteli  
1865mm'de =1/4-100 10 adet Gn küvet kapasiteli  
2335mm'de =1/4-100 13 adet Gn küvet kapasiteli

1400mm=1/4-100 7 pcs GN bin cap.  
1865mm=1/4-100 10 pcs GN bin cap.  
2335mm=1/4-100 13 pcs GN bin cap.

**PIZZA HAZIRLIK ÜNİTESİ - BORU AYAKLI  
PIZZA PREPARATION UNIT / ELEVATED GARNITURE UNIT**

**SGB**

MODEL	EBATLAR	İÇ SICAKLIK	KAPASİTE	GÜÇ	PAKET ÖLÇÜSÜ	AĞIRLIK
	DIMENSIONS	TEMPERATURE	CAPACITY	POWER	PACKING DIMENSIONS	WEIGHT
	mm	°C	Lt.	W	mm	Kg
INO-SGB 140	1400x700x1300	-2 / + 8	280	840	1450x750x1500	170
INO-SGB 190	1865x700x1300	-2 / + 8	465	840	1900x750x1500	215
INO-SGB 240	2335x700x1300	-2 / + 8	640	910	2400x750x1500	235

\* HACCP özelliği fiyata dahildir. \* Aydınlatma, tekerlek, cam kapı, çekmece, ilave tel raf, kilit opsiyoneldir. \*GN kaplar fiyata dahil değildir.  
Lighting, wheels, glass door, drawer, wire shelf and lock additions are optional. GN CONTAINERS ARE NOT INCLUDED.

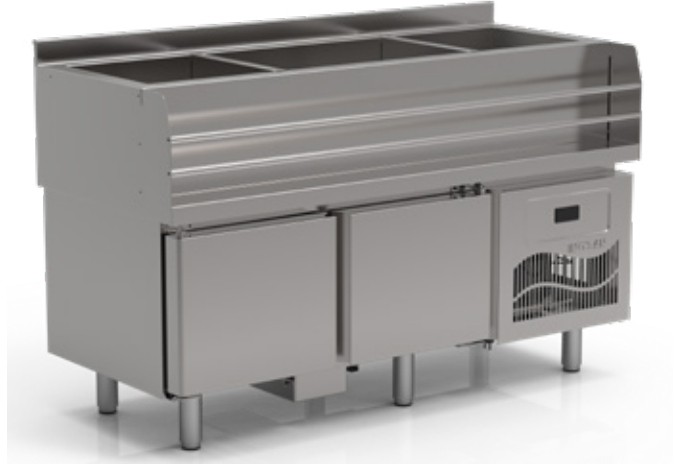
**INO-ZBC-BS**  
**INO-ZBC-BS6**
**İLAVELER**  
**ADDITIONAL ITEMS**

MODEL	EBATLAR	İÇ SICAKLIK	KAPASİTE	GÜÇ	PAKET ÖLÇÜSÜ	AĞIRLIK
	DIMENSIONS	TEMPERATURE	CAPACITY	POWER	PACKING DIMENSIONS	WEIGHT
	mm	°C	Lt.	W	mm	Kg
INO-ZBC-BS	1400x700x850	-2 / + 8	280	0,3	1450x750x1250	150
INO-ZBC-BS6	1400x600x850	-2 / + 8	465	0,3	1900x750x1250	190

**İLAVELER**  
**ADDITIONAL ITEMS**

MODEL	AÇIKLAMA / FEATURES
2047000240	ÇEKMECE FARKI, 700mm Set Altı Buzdolabı için 1/1 / Drawer for 700mm depth U/C refrigerator 1/1.
2047000241	ÇEKMECE FARKI, 600mm Set Altı Buzdolabı için 1/1 / Drawer for 600mm depth U/C refrigerator 1/1.
2047030770	ÇEKMECE FARKI, 700 mm Set Altı Buzdolabı için ½ / Drawer for 700mm depth U/C refrigerator, ½
2047030800	ÇEKMECE FARKI, 600 mm Set Altı Buzdolabı için ½ / Drawer for 600mm depth U/C refrigerator, ½



1/2



2/3



1/3

**İLAVELER**  
**ADDITIONAL ITEMS**

MODEL	AÇIKLAMA / FEATURES
2047000200	ÇEKMECE FARKI, 700mm Tezgah Tipi Buzdolabı için 1/2 / Drawer, 700mm, for counter type refrigerator 1/2.
2047000210	ÇEKMECE FARKI, 700mm Tezgah Tipi Buzdolabı için 1/3 / Drawer, 700mm, for counter type refrigerator 1/3.
2047000220	ÇEKMECE FARKI, 700mm Tezgah Tipi Buzdolabı için 2/3 / Drawer, 700mm, for counter type refrigerator 2/3
2047000201	ÇEKMECE FARKI, 600mm Tezgah Tipi Buzdolabı için 1/2 / Drawer, 600mm, for U/C refrigerator
2047000211	ÇEKMECE FARKI, 600mm Tezgah Tipi Buzdolabı için 1/3 / Drawer, 600mm, for counter type refrigerator 1/3.
2047000221	ÇEKMECE FARKI, 600mm Tezgah Tipi Buzdolabı için 2/3 / Drawer, 600mm, for counter type refrigerator 2/3.

MODEL	AÇIKLAMA / FEATURES
2047000250	CAM KAPI FARKI, Tezgah Tipi Buzdolabı için, alüminyum çerçeveli / Glass door for counter type refrigerator. Aluminium frame.
2047000251	CAM KAPI FARKI, Tezgah Tipi Buzdolabı için, paslanmaz çerçeveli sol / Glass door for counter type refrigerator. S/S frame, left.
2047000252	CAM KAPI FARKI, Tezgah Tipi Buzdolabı için, paslanmaz çerçeveli sağ / Glass door for counter type refrigerator. S/S frame, right.
2047000260	CAM KAPI FARKI, Depo Tipi Buzdolabı için, alüminyum çerçeveli / Glass door for upright refrigerator. Aluminium frame.
2047000261	CAM KAPI FARKI, Depo Tipi Buzdolabı için, paslanmaz çerçeveli / Glass door for upright refrigerator. S/S frame.

Tekerlek, Aydınlatma ve kilit sistemi opsiyoneldir. Wheel, Lighting lock system is optional

**DRY AGE BUZDOLAPLARI**  
**DRY AGE REFRIGERATORS**

- İç Ve Dış Gövde 304K. Paslanmaz
- 60 Mm İzolasyon Kalınlığı
- Özel Kumanda Sistemi - İç Nem Ve Sıcaklık Ayarı
- Otomatik Su Buharlaştırma Sistemi
- Led Aydınlatma
- R134 Veya R404a Soğutma Gazı
- Özel Rezistanslı Isı Camlı
- Dış Ortam : +32 °C , %40 Bağıl Nem
- Et Askı Sistemi 1 Kapı/Adet - Opsiyonel
- Inside & outside body AISI 304 S/S
- 60mm thickness isolation
- Special control system - internal humidity and temperature settings
- Automatic water evaporation system
- Led illumination
- Cooling gas: R134A / R404A
- Special heat-resistant glass
- Ambient temp: +32°C & %40 relative humidity
- Meat hanging system - 1 door/pc - optional

MODEL	İÇ SICAKLIK	HACİM	GÜÇ	ÖLÇÜLER	AĞIRLIK
	INNER TEMPERATURE	VOLUME	POWER	DIMENSIONS	WEIGHT
	°C	Lt.	KW	mm	Kg.
INT-FR0290	-3/+5	1300	0,76	1400*800*2050	250
INT-FR0292	-3/+5	650	0,40	700*800*2050	170



INT-FR0566



INT-FR0300



INT-FR0395

**İKİ KAPILI TESHİR BUZDOLAPLARI**  
**DOUBLE DOOR DISPLAY REFRIGERATORS**

- Wn-WI Seri İç Ve Dış Gövde Beyaz Pvc Kaplı Sac
- Gn-GI Seri İç Ve Dış Gövde
- WN-WL serie - inside & outside body white PVC coated sheet
- GN-GL serie - inside & outside body grey PVC coated sheet
- SN-SL serie - inside & outside body AISI 430 S/S
- 60mm thickness isolation
- Inside depth: 65cm
- Automatic water evaporation system
- Digital control panel
- Ambient temp: +32°C & %40 relative humidity
- Cooling gas: R134A / R404A
- Shelf additional - optional
- Sliding door - optional
- Touch digital panel - optional

MODEL	İÇ SICAKLIK	HACİM	GÜÇ	ÖLÇÜLER	AĞIRLIK
	INNER TEMPERATURE	VOLUME	POWER	DIMENSIONS	WEIGHT
	°C	Lt.	KW	mm	Kg.
INT-FR0569	-2/+8	1300	0,85	1400*800*1980	200
INT-FR0566	-2/ -25	1300	1,18	1400*800*1980	200
INT-FR0302	-2/+8	1300	0,85	1400*800*1980	200
INT-FR0300	-2/ -25	1300	1,18	1400*800*1980	200
INT-FR0399	-2/+8	1300	0,85	1400*800*1980	200
INT-FR0395	-2/ -25	1300	1,18	1400*800*1980	200



WL6-G



GL6-G



SL6-G

**TEK KAPILI TEŞHİR BUZDOLAPLARI**  
**SINGLE DOOR DISPLAY REFRIGERATORS**

- Wn-Wl Seri İç Ve Dış Gövde Beyaz Pvc Kaplı Saç
- Gn-Gl Seri İç Ve Dış Gövde

- WN-WL serie - inside & outside body white PVC coated sheet
- GN-GL serie - inside & outside body grey PVC coated sheet
- SN-SL serie - inside & outside body AISI 430 S/S
- 60mm thickness isolation
- Inside depth: 65cm
- Digital control panel
- Ambient temp: +32°C & %40 relative humidity
- Automatic water evaporation system
- Cooling gas: R134A / R404A
- Shelf additional - optional
- Touch digital panel - optional

MODEL	İÇ SICAKLIK	HACİM	GÜÇ	ÖLÇÜLER	AĞIRLIK
	INNER TEMPERATURE	VOLUME	POWER	DIMENSIONS	WEIGHT
	°C	Lt.	KW	mm	Kg.
INT-FR0572	-2/+8	650	0,35	700*800*1980	170
INT-FR0567	-2/-25	650	0,65	700*800*1980	170
INT-FR0303	-2/+8	650	0,35	700*800*1980	170
INT-FR0301	-2/-25	650	0,65	700*800*1980	170
INT-FR0400	-2/+8	650	0,35	700*800*1980	170
INT-FR0398	-2/-25	650	0,65	700*800*1980	170

- İç Ve Dış Gövde 304K. Paslanmaz / Inside & Outside Body Aısı 304 S/S
- Max. 150Mm Gn Kapa Uygun / Max. For 150Mm Gn Container
- Statik Soğutma / Static Cooling
- Dijital Termometre / Digital Thermometer
- Dış Ortam: +32 °C / Ambient Temp: +32 °C
- R134 Veya R404a Soğutma Gazı / R134 / R404a Cooling Gas

**TEŞHİR BUZDOLAPLARI**  
**DISPLAY REFRIGERATORS**

MODEL	İÇ SICAKLIK	GN - KAPASİTE	GÜÇ	ÖLÇÜLER	AĞIRLIK
	INNER TEMPERATURE	VOLUME	POWER	DIMENSIONS	WEIGHT
	°C	Ad.	KW	mm	Kg.
INT-FR0293	+4/+10	4 AD. GN 1/3	0,12	1000*390*460	35
INT-FR0294	+4/+10	5 AD. GN 1/3	0,12	1400*390*460	40
INT-FR0295	+4/+10	6 AD. GN 1/3	0,12	1550*390*460	43
INT-FR0296	+4/+10	6 AD. GN 1/3	0,12	1600*390*460	45
INT-FR0297	+4/+10	8 AD. GN 1/3	0,12	1865*390*460	51
INT-FR0298	+4/+10	10 AD. GN 1/3	0,12	2100*390*460	60
INT-FR0299	+4/+10	10 AD. GN 1/3	0,12	2150*390*460	60

Ürün ile birlikte GN kap verilmemektedir.

GN cups not included



INT-FR0002



INT-FR0004



INT-FR0006

**BAR BUZDOLAPLARI  
BAR REFRIGERATORS**

- Ss Kapı Ve Alt Panel Paslanmaz Çelik
  - Sl Sürgü Kapı
  - Dış Gövdesiyah Kaplı Pvc,
  - İç Gövde Gri Kaplı Pvc
  - Led Aydınlatma
  - Otomatik Defrost
  - Fanlı Soğutma
  - Kilitli Kapılar
  - Dış Ortam : +32 °C
  - R134 Veya R404a Soğutma Gazı
- S/S door and bottom panel
  - Sl-Sliding door
  - Outside body black PVC coated
  - Inside body grey PVC coated
  - Led illumination
  - Automatic Defrost
  - Fan cooling
  - Locks on each door
  - Ambient temp:+ 32 °C
  - Cooling gas CFC free: R134A / R404A

MODEL	İÇ SICAKLIK	HACİM	GÜÇ	ÖLÇÜLER	AĞIRLIK
	INNER TEMPERATURE	VOLUME	POWER	DIMENSIONS	WEIGHT
	°C	Ad.	KW	mm	Kg.
INT-FR0001	+2/+12	110	0,19	595*500*910	30
INT-FR0002	+2/+12	110	0,19	595*500*910	35
INT-FR0003	+2/+12	210	0,21	920*500*910	42
INT-FR0005	+2/+12	210	0,21	920*500*910	45
INT-FR0004	+2/+12	210	0,21	920*500*910	45
INT-FR0006	+2/+12	310	0,25	1380*500*910	52
INT-FR0008	+2/+12	310	0,25	1380*500*910	55
INT-FR0007	+2/+12	310	0,25	1380*500*910	55

- İç - Dış 430K. Paslanmazdır.
- Led Aydınlatma
- Otomatik Defrost
- Fanlı Soğutma
- Kilitli Kapılar
- Otomatik Defrost
- Dış Ortam : + 32 °C
- R134 Veya R404a Soğutma Gazı
- Inside & Outside body AISI 430 S/S
- Led illumination
- Automatic Defrost
- Locks on each door
- Ambient temp:+ 32 °C
- Cooling gas CFC free: R134A / R404A



INT-FR0401



INT-FR0402



INT-FR0404

**BAR BUZDOLAPLARI  
BAR REFRIGERATORS**

MODEL	İÇ SICAKLIK	HACİM	GÜÇ	ÖLÇÜLER	AĞIRLIK
	INNER TEMPERATURE	VOLUME	POWER	DIMENSIONS	WEIGHT
	°C	Lt.	KW	mm	Kg.
INT-FR0401	+2/+12	110	0,19	595*500*910	30
INT-FR0402	+2/+12	210	0,21	920*500*910	42
INT-FR0404	+2/+12	310	0,25	1380*500*910	52

- İç - Dış 430K. Paslanmazdır.
- İç Derinlik 465 Mm.
- Dijital Dokunmatik Kumanda Paneli
- Led Aydınlatma
- Otomatik Su Buharlaştırma Sistemi
- Kilitli Kapılar
- Şarap İçin Özel Ahşap Raylı Raf
- R134 Veya R404a Soğutma Gazı
- Dış Ortam : + 32 °C , %65 Bağıl Nem

- Inside & Outside body AISI 430 S/S
- Inside depth 465 mm.
- Digital touch control panel
- Led illumination
- Automatic water evaporation system
- Door lock
- Special wooden rails shelf system
- Cooling gas CFC free: R134A / R404A
- Ambient temp:+ 32 °C & %65 relative humidity



INT-FR0568



INT-FR0570



INT-FR0571

**ŞARAP BUZDOLAPLARI  
WINE COOLERS**

MODEL	İÇ SICAKLIK	ŞİŞE KAP.	GÜÇ	ÖLÇÜLER	AĞIRLIK
	INNER TEMPERATURE	VOLUME	POWER	DIMENSIONS	WEIGHT
	°C	Ad.	KW	mm	Kg.
INT-FR0568	+1/+ 20	28	0,3	600*660*905	45
INT-FR0570	+1/+ 20	100	0,4	600*660*1820	140
INT-FR0571	+1/+20&+1/+20	100	0,4	600*700*1820	150

•

- Sb - Dış Gövde Pvc Kaplı Siyah Sac
- Ss - İç Ve Dış Gövde 430K Paslanmaz Sac
- Led Aydınlatma
- Fanlı Soğutma
- Otomatik Defrost
- Kilitli Kapı
- 4 Adet Plastik Kaplı Raf
- R134 Veya R404a Soğutma Gazı
- Dış Ortam : + 32 °C ,

- SB- Outside body PVC coated black sheet
- SS- Inside & outside body AISI 430 S/S
- Led illumination
- Fan Cooling
- Automatic defrost
- Door lock
- 4 pcs. plastic coated S/S shelf
- Cooling gas CFC free: R134A / R404A
- Ambient temp:+ 32 °C



INT-FR0389



INT-FR0403

**ŞİŞE SOĞUTUCU  
BOTTLE COOLERS**

MODEL	İÇ SICAKLIK	HACİM	GÜÇ	ÖLÇÜLER	AĞIRLIK
	INNER TEMPERATURE	VOLUME	POWER	DIMENSIONS	WEIGHT
	°C	Lt.	KW	mm	Kg.
INT-FR0389	+ 2 /+ 12	400	0,3	600*600*1835	120
INT-FR0403	+ 2 /+ 12	400	0,3	600*600*1835	120

SS300 modeli iç dış 430K. paslanmazdır.

\*SS300 model in / outside AISI 430 S/S



INT-SX0063



INT-SX0015



INT-SX0016

**BAR BUZDOLAPLARI  
BAR REFRIGERATORS**

- PVC kaplı sac iç ve dış gövde.
- CFC içermeyen polüretan izolasyon.
- Yüksek basınçla enjekte edilmiş izolasyon.
- 40 mm kalınlığında polüretan izolasyon.
- Özel tasarım rolbond evaporatör.
- Kilitli cam kapılar.
- Led aydınlatmalı iç kabin
- Ayarlanabilir iç rafar.
- İç ısı dağılımını sağlayan fanlı sistem.
- R600a Soğutma Gazı

- PVC coated sheet inner and outer body.
- CFC-free polyurethane insulation.
- High pressure injected insulation.
- 40 mm thick polyurethane insulation.
- Specially designed rolbond evaporator.
- Locked glass doors.
- Led illuminated interior cabin.
- Adjustable interior shelves.
- Fan system that provides inernaş heat dissipation.
- R600a Refrigerant.

MODEL	İÇ SICAKLIK	HACİM	GÜÇ	ÖLÇÜLER	AĞIRLIK
	INNER TEMPERATURE	VOLUME	POWER	DIMENSIONS	WEIGHT
	°C	Ad.	KW	mm	Kg.
INT-SX0063	+ 2/+ 12	150	220V	600x505x850	41
INT-SX0015	+ 2/+ 12	250	220V	900x505x850	55
INT-SX0016	+ 2/+ 12	350	220V	1350x505x850	75



INT-SX0083



INT-SX0084



INT-SX0085

**BAR BUZDOLAPLARI  
BAR REFRIGERATORS**

- PVC kaplı sac iç ve dış gövde.
- CFC içermeyen polüretan izolasyon.
- Yüksek basınçla enjekte edilmiş izolasyon.
- 40 mm kalınlığında polüretan izolasyon.
- Özel tasarım rolbond evaporatör.
- Kilitli cam kapılar.
- Led aydınlatmalı iç kabin
- Ayarlanabilir iç rafar.
- İç ısı dağılımını sağlayan fanlı sistem.
- R600a Soğutma Gazı

- PVC coated sheet inner and outer body.
- CFC-free polyurethane insulation.
- High pressure injected insulation.
- 40 mm thick polyurethane insulation.
- Specially designed rolbond evaporator.
- Locked glass doors.
- Led illuminated interior cabin.
- Adjustable interior shelves.
- Fan system that provides inernaş heat dissipation.
- R600a Refrigerant.

MODEL	İÇ SICAKLIK	HACİM	GÜÇ	ÖLÇÜLER	AĞIRLIK
	INNER TEMPERATURE	VOLUME	POWER	DIMENSIONS	WEIGHT
	°C	Ad.	KW	mm	Kg.
INT-SX0083	+ 2/+ 12	150	220V	600x505x850	45
INT-SX0084	+ 2/+ 12	250	220V	900x505x850	60
INT-SX0085	+ 2/+ 12	350	220V	1350x505x850	80

- İç - Dış Gövde 304K. Paslanmaz
- 75 Mm İzolasyon Kalınlığı
- İç Derinlik : 65 Cm. ( 2/1 Gn Kapasiteli )
- Otomatik Su Buharlaştırma Sistemi
- Dijital Kontrol Paneli
- R134 Veya R404a Soğutma Gazı
- Dış Ortam : + 32 °C , %65 Bağlı Nem
- Raf İlavesi - Opsiyonel
- Haccp Dijital - Opsiyonel
- Inside & outside body AISI 304 S/S
- 75mm thickness isolation
- Inside depth: 65cm
- Automatic water evaporation system
- Digital control panel
- Cooling gas CFC free: R134A / R404A
- Ambient temp:+ 32 °C and %65 relative humidity
- Shelf additional - optional
- Digital HACCP - optional



INT-FR0388

 SOĞUK BANKET ARABASI  
COLD BANQUET TROLLEY

MODEL	İÇ SICAKLIK	HACİM	GÜÇ	ÖLÇÜLER	AĞIRLIK
	INNER TEMPERATURE	VOLUME	POWER	DIMENSIONS	WEIGHT
	°C	Lt.	KW	mm	Kg.
INT-FR0388	- 2/+ 8	12 AD. GN 2/1	0,33	710*840*1670	130
INT-FR0394	- 18 /- 20	12 AD. GN 2/1	0,57	710*840*1670	135

- İç Gövde AISI 304 2B Paslanmaz Çelik / Inside body AISI 304 S/S
- Dış Gövde AISI 304 SB Paslanmaz Çelik / Outside body AISI 304 S/S
- İç Derinlik 43cm/53cm (GN 1/1 Kapasiteli) / Inside depth: 43cm/53cm (GN 1/1 cap)
- 35/40 Kg m3 Çevre Dostu HCFC Free Poliüretan İzolasyon / 35/40 Kg m3 Environment friendly HCFC free Polyurethane isolation
- Dijital Kumanda Paneli / Digital control panel
- Elektrik Rezistanslı Otomatik Defrost / Automatic Defrost with electric resistance
- Özel Su Buharlaştırma Sistemi (Sıcak Gaz) / Special water evaporation system
- Yüksekliği Ayarlanabilir Paslanmaz Ayaklar / Height Adjustable stainless feet
- Özel Kapı Menteşe Sistemi / Special door hinge system
- Temizlenebilir ve Sökülebilir Manyetik Kapı Contası / Removable and cleanable magnetic joint
- CFC Free Soğutma Gazı R134 A / R404 A - CFC FREE Cooling gas 134A / R404A
- Dış Ortam Sıcaklığı +43 °C & %65 Nem - Ambient temp: +43°C & %65 relative humidity



INT-FR0606



INT-FR0467



INT-FR0468

BLAST CHILLER

MODEL	SOĞUTMA SICAKLIĞI	DONDURMA SICAKLIĞI	TEPSİ KAP.	SOĞUTMA KAP.	DONDURMA KAP.	TEPSİ MESAFESİ	VOLTAJ	GÜÇ	ÖLÇÜLER	DİŞ HAVA SICAKLIĞI	AĞIRLIK
	°C	°C	GN 1/1	90 dk. Kg.	240 dk. Kg.	mm	V/50hz	Kw	mm	°C	Kg.
INT-FR0466	+90/+3	+90/-18	15	35	30	50	380	3.5	800x850x2010	+38	263
INT-FR0467	+90/+3	+90/-18	5	20	15	50	230	1.4	800x750x900	+38	161
INT-FR0468	+90/+3	+90/-18	5	20	15	50	230	1.4	900x1010x1060	+38	161

INT-FR0468 Modeli üzerine direkt fırın koyulacak şekilde dizayn edilmiştir.

INT-FR0468 is designed to be placed under the oven directly.





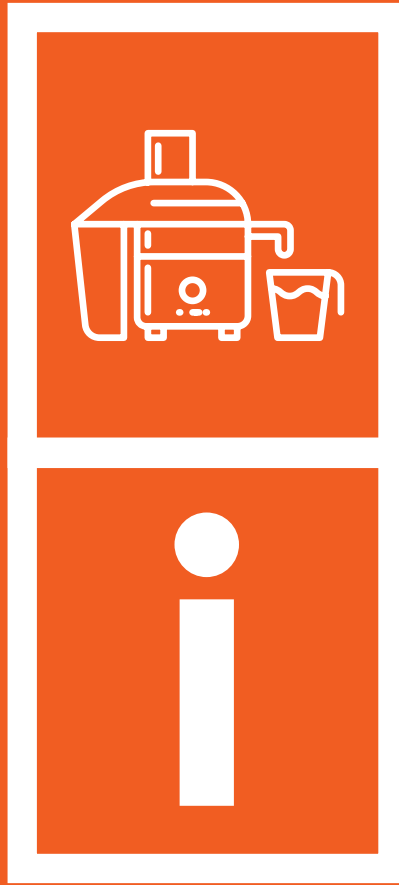

İthal Ürünler

Imported Products



# İTHAL ÜRÜNLER

IMPORTED PRODUCTS



- Buz makineleri, et-sebze doğrama makineleri, bulaşık yıkama makineleri, konveyörlü bulaşık yıkama makineleri, bulaşık yıkama kasetleri, bar ekipmanları, salat bar, gıda dilimleme makineleri, pizza hamuru açma makineleri, yiyecek taşıma konteynerleri, isotermik tepsi, çöp öğütücüleri, temizlik hortumları, sebze yıkama makineleri, mikserler, buharlı konveksiyonlu fırınlar, narenciye sıkma makineleri, hamur açma makineleri,espresso-kahve makineleri, filtre kahve makineleri, meşrubatlıklar.

- Ice makers, meat-vegetable processors, dishwashers, rack type dishwashers, dishwasher racks, bar equipment, salad bar, food slicers, pizza dough sheeters, food transport container isothermic tray, waste disposers, hose reels, vegetable washing machines, mixers, combi steamers, citrus juicers, dough sheeters, espresso-coffee machines, filter coffee machines, beverage dispensers.



## Icematic

### BUZ MAKİNELERİ



**PARMAK BUZ / HALLOW ICE**

K SERİSİ / K SERIES

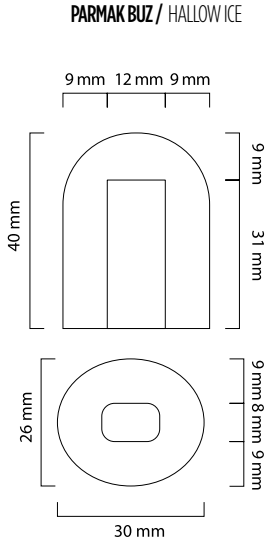

**PARLAK BUZ / BRIGHT CUBE**

C SERİSİ / C SERIES

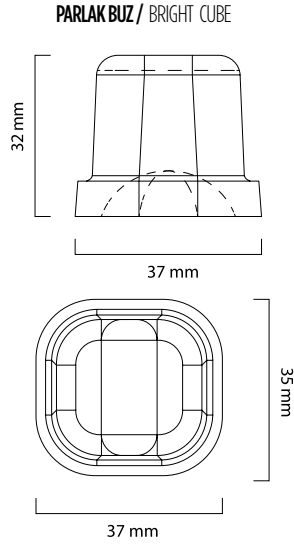

**KÜP BUZ / ICE CUBE**

M SERİSİ / M SERIES

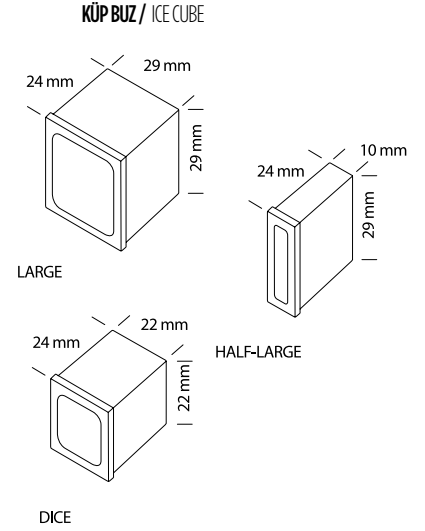

**KAR BUZ / ICE FLAKE**

B SERİSİ / B SERIES



**NUGGET BUZ / ICE NUGGET**

G SERİSİ / G SERIES

FİYAT  
LİSTESİNİ  
GÖRMEK İÇİN  
OKUTUN



**İNOKSAN**

SPREY SİSTEMLİ BUZ MAKİNELERİ / SPRAY SYSTEM ICEMAKERS

**Icematic**



**CAS-C28**



**CAS-C38**



**CAS-C46**

KENDİNDEN DEPOLU BUZ MAKİNESİ / Icematic  
SELF CONTAINED ICE MAKERS

MODEL	ÖZELLİKLERİ / FEATURES	EBAT / DIMENSION
CAS-C28	Kapasite: 20 Kg - Depo: 6,5 Kg. - Paslanmaz Ön ve Yan Paneller Capacity: 20 Kg - Storage: 6,5 Kg. - Stainless Steel Front and Side Panel	340x480x605 mm
CAS-C38	Kapasite: 36 Kg - Depo: 11,5Kg. - Paslanmaz Ön ve Yan Paneller Capacity: 36 Kg - Storage: 11 Kg. - Stainless Steel Front and Side Panel	400x540x690 mm
CAS-C46	Kapasite: 41 Kg - Depo: 15Kg. - Paslanmaz Ön ve Yan Paneller Capacity: 41 Kg - Storage: 15 Kg. - Stainless Steel Front and Side Panel	500x540x690 mm



**CAS-C54**



**CAS-C70**



**CAS-C90**

KENDİNDEN DEPOLU BUZ MAKİNESİ / Icematic  
SELF CONTAINED ICE MAKERS

MODEL	ÖZELLİKLERİ / FEATURES	EBAT / DIMENSION
CAS-C54	Kapasite: 54 Kg-900 adet/gün - Depo: 18Kg. - Paslanmaz Ön ve Yan Paneller Capacity: 54 Kg-900 Pcs./day - Storage:18 Kg. - Stainless Steel Front and Side Panel	500x580x800mm
CAS-C70	Kapasite: 72 Kg/gün - 1200 adet/gün buz - Depo: 40Kg. - Paslanmaz Ön ve Yan Paneller Capacity: 72 Kg-1200 Pcs./day - Storage:40 Kg. - Stainless Steel Front and Side Panel	700x580x980mm
CAS-C90	Kapasite: 90 Kg/gün - 1450 adet/gün buz-Depo: 40Kg. - Paslanmaz Ön ve Yan Paneller Capacity: 90 Kg-1450 Pcs./day - Storage:40 Kg. - Stainless Steel Front and Side Panel	700x580x980mm

**FİYAT  
LİSTESİNİ  
GÖRMEK İÇİN  
OKUTUN**



**PEDAL SİSTEMLİ BUZ MAKİNELERİ / PEDAL SYSTEM ICEMAKERS**

**Icematic®**



**CAS-K23**



**CAS-K25**



**CAS-K36**

**KENDİNDEN DEPOLU BUZ MAKİNESİ / Icematic  
SELF CONTAINED ICE MAKERS**

MODEL	ÖZELLİKLERİ / FEATURES	EBAT / DIMENSION
CAS-K23	Kapasite: 21 Kg - Depo: 7 Kg. - Tamamen Paslanmaz Dış Gövde Capacity: 21 Kg - Storage:7 Kg. - External Body entirely in stainless steel	340x545x690 mm
CAS-K25	Kapasite: 25 Kg - Depo: 10 Kg. - Tamamen Paslanmaz Dış Gövde Capacity: 25 Kg - Storage:10 Kg. - External Body entirely in stainless steel	400x545x690 mm
CAS-K36	Kapasite: 37 Kg - Depo: 12 Kg. - Tamamen Paslanmaz Dış Gövde Capacity: 37 Kg - Storage:12 Kg. - External Body entirely in stainless steel	450x545x690 mm



**CAS-K45**



**CAS-K62**



**CAS-K80**



**CAS-K95**



**CAS-K150**

**KENDİNDEN DEPOLU BUZ MAKİNESİ / Icematic  
SELF CONTAINED ICE MAKERS**

MODEL	ÖZELLİKLERİ / FEATURES	EBAT / DIMENSION
CAS-K45	Kapasite: 45 Kg - Depo: 16 Kg. - Tamamen Paslanmaz Dış Gövde Capacity: 45 Kg - Storage:16 Kg. - External Body entirely in stainless steel	500x600x693 mm
CAS-K62	Kapasite: 60 Kg - Depo: 28 Kg. - Tamamen Paslanmaz Dış Gövde Capacity: 60 Kg - Storage:28 Kg. - External Body entirely in stainless steel	600x585x956 mm
CAS-K80	Kapasite: 75 Kg - Depo: 36 Kg. - Tamamen Paslanmaz Dış Gövde Capacity: 75 Kg - Storage:36 Kg. - External Body entirely in stainless steel	700x585x956 mm
CAS-K95	Kapasite: 92 Kg - Depo: 40 Kg. - Tamamen Paslanmaz Dış Gövde Capacity: 92 Kg - Storage:40 Kg. - External Body entirely in stainless steel	800x585x956 mm
CAS-K150	Kapasite: 142 Kg - Depo:70 Kg. - Tamamen Paslanmaz Dış Gövde Capacity: 142 Kg - Storage:70 Kg. - External Body entirely in stainless steel	920x650x1279 mm

**CAS-M145**
**CAS-M205**
**CAS-M305**
**CAS-M405**
**CAS-M505**
**MODÜLER BUZ MAKİNELERİ  
MODULAR ICE MAKERS**

MODEL	ÖZELLİKLERİ / FEATURES	EBAT / DIMENSION
CAS-M145	Kapasite:150 Kg / Gün Paslanmaz Çelik Capacity 150 Kg/day Stainless Steel	560x620x575 mm
CAS-M205	Kapasite:220 Kg / Gün Paslanmaz Çelik Capacity 220 Kg/day Stainless Steel	760x620x575 mm
CAS-M305	Kapasite:300 Kg / Gün Paslanmaz Çelik Capacity 300 Kg/day Stainless Steel	760x620x575 mm
CAS-M405	Kapasite:405 Kg / Gün Paslanmaz Çelik Capacity 405 Kg/day Stainless Steel	760x620x725 mm
CAS-M505	Kapasite:450 Kg / Gün Paslanmaz Çelik Capacity 450 Kg/day Stainless Steel	760x620x725 mm

**CAS-B95C**
**CAS-B305**
**CAS-B505**
**KAR BUZ MAKİNELERİ  
ICE FLAKERS**

MODEL	ÖZELLİKLERİ / FEATURES	EBAT / DIMENSION
CAS-B95C	Kapasite: 90 Kg / Gün, Kendinden Depolu, Depo Kapasite: 20Kg Paslanmaz Çelik Capacity 90 Kg/day, with incorporated storage bin Storage Cap.:20 Kg, Stainless Steel	500X600X695 mm
CAS-B305	Kapasite:320 Kg / Gün Paslanmaz Çelik Capacity 320 Kg/day, Stainless Steel	540x665x650 mm
CAS-B505	Kapasite:570 Kg / Gün Paslanmaz Çelik Capacity 570 Kg/day, Stainless Steel	540X665X790 mm

**DEPO KAPAKLARI  
BIN KITS**

MODEL	
CAS-KM205	CAS-M145, CAS-M195 model buz makinesi ile CAS-MG205 model depo birlikte verildiğinde gereklidir.
CAS-KM305	CAS-M205, CAS-M305, CAS-M405, CAS-M505 model buz makineleri ile CAS-MG305 depo birlikte verildiğinde gereklidir.
CAS-KF205	CAS-B125, CAS-B205, CAS-B305, CAS-B505, CAS-G270, CASG470 model buz makineleri ile CAS-MG205, CAS-MG255 depo birlikte verildiğinde gereklidir.
CAS-KF305	CAS-B125, CAS-B205, CAS-B305, CAS-B505 model buz makineleri ile CAS-MG305 depo birlikte verildiğinde gereklidir.
CAS-KFM505	CAS-G270, CAS-G470, CAS-B125, CAS-B205, CAS-B305, CAS-B505, CAS-M205, CAS-M305, CAS-M405, CAS-M505 model buz makineleri ile CAS-MG505 depo birlikte verildiğinde gereklidir.

**NUGGET BUZ MAKİNALARI  
NUGGET ICE MAKERS**
**CAS-G270F**
**CAS-G470F**

MODEL	EBATLAR DIMENSIONS	KAPASİTE CAPACITY	UYGUN DEPO PROPER BIN	VOLTAJ VOLTAGE	NETAĞIRLIK NET WEIGHT
	mm	Kg	-	V	Kg
CAS-G270F	538X663X659 mm	270	MG105-MG155-MG205-MG255- MG305-MG405-MG505	220-240V/1/50Hz	78
CAS-G470F	538X663X790 mm	470	MG205-MG255-MG305-MG405- MG505	220-240V/1/50Hz	94

**DEPOLAR / BINS**

**CAS-MG105**
**CAS-MG205**
**CAS-MG305**
**CAS-MG505**
**CAS-MB500**

MODEL	CAS-MG105	CAS-MG205	CAS-MG305	CAS-MG505	CAS-MB500
Ebatlar / Dimensions	569X841X1045 mm	769X849X1048 mm	1081X824X968 mm	1331x880x1270 mm	1220x1125x1428 mm
Depo Kapasitesi Storage Capacity	129 kg	181 kg	252 kg	406 kg	553 kg
Voltaj / Voltage	220-240V/1/50Hz	220-240V/1/50Hz	220-240V/1/50Hz	220-240V/1/50Hz	380-415V/3/50Hz
Net Ağırlık(Kg) / Net Weight	36	43	48	77	142

**Cihaz / depo kombinasyonları  
Ice Maker Bin Combinations**

B125 + KFD 105-155  
B205 + KFD 105-155  
B305 + KFC 105-155  
G270 + KFC 105-155

M145 + KM 205-255  
M195 + KM 205-255  
B125 + KF 205-255  
B205 + KF 205-255  
B305 + KF 205-255  
B505 + KF 205-255  
G270 + KF 205-255  
G470 + KF 205-255

M205 + KM 305  
M305 + KM 305  
M405 + KM 305  
M505 + KM 305  
B125 + KF 305  
B205 + KM 305  
B305 + KM 305  
B505 + KM 305  
G270 + KM 305  
G470 + KM 305

M205 + KFM 505  
M305 + KFM 505  
M405 + KFM 505  
M505 + KFM 505  
B125 + KFM 505  
B205 + KFM 505  
B305 + KFM 505  
B505 + KFM 505  
G270 + KFM 505  
G470 + KFM 505

B1005 + KF 1000X2



MODEL	KAPASİTE	ÜRÜN AĞIRLIĞI	MAKSİMUM GÜÇ	EBAT	AMBALAJ ÖLÇÜLERİ
	mm	Kg	-	V	Kg
INT-IC0006	30 Kg	48 Kg	540 W	39 x 60 x 73	44 x 65 x 100
INT-IC0007	45 Kg	56 Kg	620 W	48 x 60 x 82	53 x 65 x 110
INT-IC0008	85 Kg	82 kg	910 W	61 x 60 x 82	66 x 65 x 110
INT-IC0009	130 Kg	82 kg	910 W	73 X 75 X 90	78 X 80 X 95
INT-IC0010	250 kg	86 kg	1100 W	82 x 72 x 60	87 x 77 x 75
INT-IC0012	500 kg	117 kg	2440 W	82 x 72 x 83	87 x 77 x 98



MODEL	EBATLAR	KAPASİTE	UYGUN DEPO	VOLTAJ	NETAĞIRLIK
	DIMENSIONS	CAPACITY	PROPER BIN	VOLTAGE	NET WEIGHT
	mm	Kg	-	V	Kg
INT-IC0011	180 Kg	56 Kg		82 x 77 x 104	88 x 81 x 120
INT-IC0013	220 Kg	63 Kg		82 x 77 x 120	88 x 81 x 135

# +3°

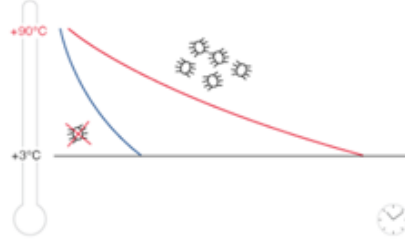

**Şok soğutucusuz  
bakteri riski**

**Şok soğutuculu  
yiyeceklerin güvenliği**

# -18°

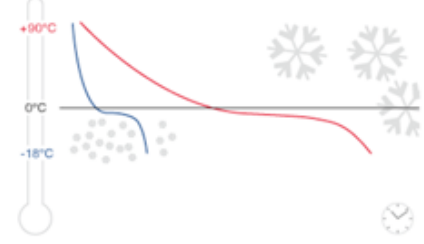

**Şok soğutucusuz  
Makro kristal**

**Şok soğutuculu  
Mikro kristal**

**CAS-V15**

**CAS-CT20**

**CAS-CT30**

**CAS-CT40**

MODEL	ÖZELLİKLERİ / FEATURES	EBAT/ DIMENSION
CAS-V10-35	Şok soğutucu/Dondurucu, 10xGN1/1 -600x400 , +90°C +3°C'ye 35Kg, +90°C +18°C'ye 25Kg Blast Chiller/Freezer, 10xGN1/1 -600x400 , +90°C to 3°C 35Kg, +90°C -18°C 25Kg	840x831x1548 mm
CAS-V15-40	Şok soğutucu/Dondurucu, 15xGN1/1 -600x400 , +90°C +3°C'ye 40Kg, +90°C +18°C'ye 30Kg Blast Chiller/Freezer, 15xGN1/1 -600x400 , +90°C to 3°C 40Kg, +90°C +18°C 30Kg	840x880x1548 mm
CAS-V15-65	Şok soğutucu/Dondurucu, 15xGN1/1 -600x400 , +90°C +3°C'ye 65Kg, +90°C +18°C'ye 50Kg Blast Chiller/Freezer, 15xGN1/1 -600x400 , +90°C to +3°C 65Kg	840x880x2002 mm
CAS-V15-2-70	Şok soğutucu/Dondurucu, 15xGN2/1 -600x400 , +90°C +3°C'ye 70Kg, +90°C +18°C'ye 55Kg Blast Chiller/Freezer, 15xGN2/1 -600x400 , +90°C to +3°C 70Kg, +90°C +18°C 55Kg	840x1250x2002 mm
CAS-CT10-35	Touch Panel Şok soğutucu/Dondurucu, 10xGN1/1 -600x400 , +90°C +3°C'ye 35 Kg, +90°C +18°C'ye 25Kg Touch Panel Blast Chiller/Freezer, 10xGN1/1 -600x400 , +90°C to +3°C 35 Kg, +90°C to +18°C 25Kg	840x895x1497 mm
CAS-CT15-65	Touch Panel Şok soğutucu/Dondurucu, 15xGN1/1 -600x400 , +90°C +3°C'ye 65 Kg, +90°C +18°C'ye 50Kg Touch Panel Blast Chiller/Freezer, 15xGN1/1 -600x400 , +90°C to +3°C 65 Kg, +90°C to +18°C 50 Kg	840x995x1952 mm
CAS-CT15-2-70	Touch Panel Şok soğutucu/Dondurucu, 15xGN1/1 -600x400 , +90°C +3°C'ye 70 Kg, +90°C +18°C'ye 55 Kg Touch Panel Blast Chiller/Freezer, 15xGN1/1 -600x400 , +90°C to +3°C 70 Kg, +90°C to +18°C 55 Kg	840x1365x1952 mm
CAS-CT20-80	Şok soğutucu/Dondurucu, 1 araba GN2/1, +95°C +3°C'ye 80Kg, +95°C (-18)°C'ye 65Kg Blast Chiller/Freezer, 1 trolley GN2/1, +95°C +3°C to 80Kg, +95°C (-18)°C 65Kg	890x1440x2410 mm
CAS-CT20-110	Şok soğutucu/Dondurucu, 1 araba GN2/1, +95°C +3°C'ye 110Kg, +95°C (-18)°C'ye 95Kg Blast Chiller/Freezer, 1 trolley GN2/1, +95°C to +3°C 110Kg, +95°C (-18)°C 95Kg	890x1440x2410 mm
CAS-CT30-110	Şok soğutucu/Dondurucu, 1 araba GN2/1, +95°C +3°C'ye 110Kg, +95°C (-18)°C'ye 95Kg Blast Chiller/Freezer, 1 trolley GN2/1, +95°C to +3°C 110Kg, +95°C (-18)°C 95Kg	1415x1225x2360 mm
CAS-CT30-140	Şok soğutucu/Dondurucu, 1 araba GN2/1, +95°C +3°C'ye 140Kg, +95°C (-18)°C'ye 125Kg Blast Chiller/Freezer, 1 trolley GN2/1, +95°C to +3°C 140Kg, +95°C (-18)°C 125Kg	1415x1225x2360 mm
CAS-CT40-150	Şok soğutucu/Dondurucu, 1 araba GN2/1, +95°C +3°C'ye 150Kg, +95°C (-18)°C'ye 135Kg Blast Chiller/Freezer, 1 trolley GN2/1, +95°C to +3°C 150Kg, +95°C (-18)°C 135Kg	1580x1390x2350 mm
CAS-CT40-200	Şok soğutucu/Dondurucu, 1 araba GN2/1, +95°C +3°C'ye 200Kg, +95°C (-18)°C'ye 175Kg Blast Chiller/Freezer, 1 trolley GN2/1, +95°C to +3°C 200Kg, +95°C (-18)°C 175Kg	1580x1390x2350 mm

**BLAST CHILLER**

winterhalter

## BULAŞIK YIKAMA MAKİNELERİ ..... DISHWASHING MACHINES



WIN-UCS



WIN-UCM



WIN-UCL

BARDAK, TABAK, BISTRO VE ÇATAL KAŞIK YIKAMA MAKİNESİ  
GLASS, PLATE, BISTRO AND CUTLERY WASHING MACHINES

ÖZELLİKLER / FEATURES	WIN-UCS	WIN-UCM	WIN-UCL
Sepet Ölçüsü / Rack Dimensions	400X400 mm	500X500 mm	500X500 mm
Teorik Güç / Bulaşık Yıkama Programı 1 / 2 / 3 Theoretical Capacity / Washing Program 1 / 2 / 3	22 / 32 / 48 sepet/saat/rack/h kap./cap.	40 / 28 / 24 sepet/saat/rack/h kap./ cap.	40 / 32 / 28 sepet/saat/rack/h kap./cap.
Kısa Program / Short Program	77 sepet / saat/ rack/h	66 sepet / saat/ rack/h	66 sepet / saat/ rack/h
Yıkama Başına Durulama Suyu İhtiyacı Rinse Water Consumption Per Cycle	2.4 Lt	2.4 Lt	2.4 Lt
Durulama Sıcaklığı / Rinse Temperature	65 °C	85 °C	65-85 °C
Tank Sıcaklığı / Tank Temperature	62 °C	62 °C	62 °C
Ebat Ve Ağırlık / Dimensions And Weight	460x617x725 mm- 68 Kg	600x617x725 mm- 74 Kg	600x617x820 mm- 74 Kg

### WIN-P-50

#### BULAŞIK YIKAMA MAKİNESİ DISHWASHING MACHINE

#### ÖZELLİKLER / FEATURES

Kapasite Basket/Saat / Capacity Rack / h	60/30/15
Program Sayısı / Programs	3
Tank Kapasitesi / Tank Capacity	35 lt
Sepet Ölçüsü / Rack Dimensions	500 x500
Ebat ve Ağırlık / Dimensions and Weight	635x750x1485 mm / 128 Kg



İTHAL ÜRÜNLER / BULAŞIK YIKAMA MAKİNELERİ  
IMPORTED PRODUCTS / DISHWASHING MACHINES



**BULAŞIK YIKAMA MAKİNELERİ**  
.....  
**DISHWASHING MACHINES**



**ELE-FAST30-S** BARDAK YIKAMA MAKİNESİ  
GLASS WASHING MACHINE

MODEL / ELE-FAST30-S
Su yumuşatıcı / Water softener
Bardak yüksekliği / Glass Height: 250mm
Sepet / Rack: 350x350 mm
Voltaj / Voltage: 230/50/1
Ebat / Dimension: 401x490x595 mm



**ELE-FAST40-S** BARDAK YIKAMA MAKİNESİ  
GLASS WASHING MACHINE

MODEL / ELE-FAST40-S
Su yumuşatıcı / Water softener
Bardak yüksekliği / Glass Height : 255mm
Sepet / Rack: 390x390 mm
Voltaj / Voltage: 230/50/1
Ebat / Dimension: 436x535x670 mm



**ELE-FAST60** BULAŞIK YIKAMA MAKİNESİ  
DISHWASHING MACHINE

MODEL / ELE-FAST60
Tabak yüksekliği / Plate Height :365mm
Sepet / Rack: 500x500 mm
Voltaj / Voltage: 230-50-1
Ebat / Dimension: 575x605x820 mm



**ELE-RIVER43TDE** BARDAK YIKAMA MAKİNESİ  
GLASS WASHING MACHINE

ELE-RIVER43TDE
Program sayısı/süresi: 3/90-120-150sn.
Çift Cidarlı / Double wall body and door, Su Yumuşatıcı (Water Softener)
Drenaj pompası / Drain Pump
Su tüketimi: 1,8lt. - Max güç 3,5 kW
Voltaj / Voltage: 230/50/1
Ebat / Dimension: 465x556x695 mm
Standart ekipman, 2 adet 40x40 basket, 1adet kaşık sepeti



**ELE-RIVER63TDE** BULAŞIK YIKAMA MAKİNESİ  
DISHWASHING MACHINE

ELE-RIVER63TDE
Program sayısı/süresi: 3/72-110-150sn.
Çift Cidarlı / Double wall body and door, Su Yumuşatıcı (Water Softener)
Drenaj pompası / Drain Pump
Su tüketimi: 2,4lt. - Max güç 8,1 kW
Voltaj / Voltage: 400/50/3
Ebat / Dimension: 600x600x820 mm
1 adet 50x50 tabak basket, 1 adet 50x50 bardak basket, 1 adet kaşık sepeti



**ELE-RIVER83TDE** BULAŞIK YIKAMA MAKİNESİ  
DISHWASHING MACHINE

ELE-RIVER83TDE
Program sayısı/süresi: 3/60-90-120sn.
Çift Cidarlı / Double wall body and door, Su Yumuşatıcı (Water Softener)
Drenaj pompası / Drain Pump
Su tüketimi: 2,4lt. - Max güç 8,7 kW
Voltaj / Voltage: 400/50/3
Ebat / Dimension: 721x755x1565/2080 mm
1 adet 50x50 tabak basket, 1 adet 50x50 bardak basket, 1adet kaşık sepeti

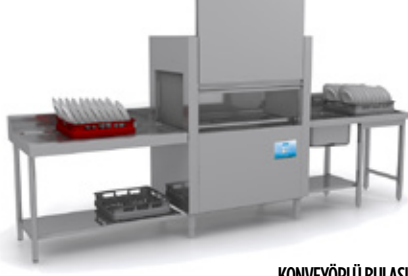

KONVEYÖRLÜ BULAŞIK  
YIKAMA MAKİNESİ  
RACK TYPE  
DISHWASHER

### ELE-NIAGARA-411.1

ELE-NIAGARA-411.1
120 Basket / h
Çift Cidarlı / Double wall body and door
Yıkama / Durulama / Wash / Rinse
Ebat / Dimension: 1150x770x1.615 / 2.088 mm
A model kurutma ünitesi ilave edilmelidir. "A" model drying unit must be added

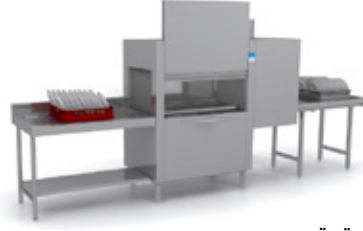

KONVEYÖRLÜ BULAŞIK  
YIKAMA MAKİNESİ  
RACK TYPE  
DISHWASHER

### ELE-NIAGARA-412.1

ELE-NIAGARA-412.1
160 Basket / h
Çift Cidarlı / Double wall body and door
Yıkama / Durulama / Wash / Rinse
Ebat / Dimension: 1150x770x1.615 / 2.088 mm
A model kurutma ünitesi ilave edilmelidir. "A" model drying unit must be added



KONVEYÖRLÜ BULAŞIK  
YIKAMA MAKİNESİ  
RACK TYPE  
DISHWASHER

### ELE-NIAGARA-412.2

ELE-NIAGARA-412.2
270 Basket / h
Çift Cidarlı / Double wall body and door
Ön Yıkama / Yıkama / Durulama / Prewash / Wash / Rinse
Ebat / Dimension: 1.968x770x1.615 / 2.088 mm
A model kurutma ünitesi ilave edilmelidir. "A" model drying unit must be added

\*Tezgaah ve aksesuarlar fiyata dahil değildir. Tables and accessories are not included in price.



KURUTMA TÜNELİ A  
DRYING UNIT

### ELE-A

MODEL / ELE-A
6.0 kW
400/50/3
Ebat / Dimension: 600x770 mm



KAZAN YIKAMA MAKİNESİ  
UTENSİL  
WASHER

### ELE-RIVER348

ELE-RIVER348
Deterjan ve Partatıcı Dispanserli With detergent and rinse aid dispenser
Ekonomik Yıkama Programlı With economic washing program
Basket: 1310x700 mm
İç Yükseklik / Inside Height: 850 mm
Ebat / Dimension: 1470x850x1960 mm



KAZAN YIKAMA MAKİNESİ  
UTENSİL  
WASHER

### ELE-NIAGARA-244D

ELE-NIAGARA-244D
Basket: 560x630 mm
İç Yükseklik / Inside Height: 850 mm
Ebat / Dimension: 720x780x1930 mm



KAZAN YIKAMA MAKİNESİ  
UTENSİL  
WASHER

### ELE-RIVER-347

ELE-RIVER-347
Deterjan ve Partatıcı Dispanserli With detergent and rinse aid dispenser
Basket: 700x700 mm
İç Yükseklik / Inside Height: 850 mm
Ebat / Dimension: 850x850x1960 mm



**KONVEYÖRLÜ BULAŞIK YIKAMA MAKİNELERİ**  
**YIKAMA MAKİNELERİ**  
 .....  
**RACK TYPE WASHING MACHINES**

**KONVEYÖRLÜ BULAŞIK YIKAMA MAKİNESİ**  
**RACK TYPE DISHWASHER**

**ELE-RIVER-M-414.1**

Çift cidarlı ,5 programlı  
 Double wall, with 5 programs

LCD grafik ekran  
 LCD graphic display

160-210 Basket /h

Yıkama/Çoklu Durulama/Isı geri kazanım  
 washing/multi rinse/Heat Recovery

Kurutma DAHİL / Dryer included

Su tüketimi / water consumption : 120 lt /saat/h

Ebat / Dimension :  
 2278x770x1615 / 2088 mm



**ELE-RIVER-M-414.1**

**KONVEYÖRLÜ BULAŞIK YIKAMA MAKİNESİ**  
**RACK TYPE DISHWASHER**

**ELE-RIVER-M-414.2**

Çift cidarlı ,5 programlı  
 Double wall, with 5 programs

LCD grafik ekran  
 LCD graphic display

210-270 Basket /h

Ön Yıkama/Yıkama/Çoklu Durulama/Isı geri kazanım  
 Pre wash /washing/multi rinse/Heat Recovery

Kurutma DAHİL / Dryer included

Su tüketimi / water consumption: 150 lt / saat / h

Ebat / Dimension :  
 3406x770x16157 / 2088mm



**ELE-RIVER-M-414.2**

**KONVEYÖRLÜ BULAŞIK YIKAMA MAKİNESİ**  
**RACK TYPE DISHWASHER**

**ELE-RIVER-M-414.3**

Çift cidarlı ,5 programlı  
 Double wall, with 5 programs

LCD grafik ekran  
 LCD graphic display

250-300 Basket /h

Ön Yıkama/Yıkama1/Yıkama2/Çoklu Durulama/  
 Isı geri kazanım

Pre wash /Wash 1/ Wash 2 /  
 multi rinse/Heat Recovery

Kurutma DAHİL / Dryer included

Su tüketimi / water consumption: 170 lt /saat

Ebat / Dimension : 4534x770x1565 mm



**ELE-RIVER-M-414.3**

\*Tezgah ve aksesuarlar fiyata dahil değildir.  
 Tables and accessories are not included in price.

# GIDA DİLİMLEME MAKİNESİ

.....  
IMPORTED PRODUCTS



- Hassas kesim
- Kolay mekanik işlem
- El koruması güvenli kullanım sağlar
- Değiştirilebilir bileme taşı
- Sıçratma koruması
- Kolay temizlenebilir
- Yüksek kaliteli AISI 304 paslanmaz çelikten yapılmış gövde
- Eğimli kesici
- Özellikle et ürünleri için uygundur
- Elektrik bağlantısı: 1 / N / PE 230 Volt / 50 Hz
- Hijyen ve güvenlik kurallarına göre üretilmiştir
- CE ve EAC standartlarına uygun üretilmiştir
- Ürün Avrupa gıda standartlarına uygundur



**GGM-AMH250A**

GIDA DİLİMLEME  
MAKİNESİ

**GGM-AMH275A**

GIDA DİLİMLEME  
MAKİNESİ

**GGM-AMH300A**

GIDA DİLİMLEME  
MAKİNESİ

MODEL	Elektrik Girişi:	Bıçak Çapı	Kesme Genişliği	Kesme Kalınlığı	EBAT	AĞIRLIK
GGM-AMH250A	220-240V 50Hz	250	Max. 180	0,2 - 12	482*414*364	17
GGM-AMH275A	220-240V 50Hz	275	Max. 180	0,5 - 15	543*462*430	23,3
GGM-AMH300A	220-240V 50Hz	300	Max. 200	0,5 - 15	576*465*430	24,3



## HAZIRLAMA MAKİNELERİ

PREPARATION MACHINES



**AUR-78483-SO-PA**

ET KEMİK TESTERESİ  
BONE SAW



**AUR-78394**

ET KEMİK TESTERESİ STANDI  
STAND FOR BONE SAW



**AUR-78484-SO-MA**

ET KEMİK TESTERESİ  
BONE SAW

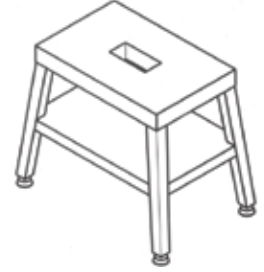

**AUR-78394**

ET KEMİK TESTERESİ STANDI  
STAND FOR BONE SAW



**SEE-STM-5303-AO**

HAMUR AÇMA MAKİNESİ / SET ÜSTÜ  
DOUGH SHEETER / TABLE TOP

**SEE-STM-513-A**

Konveyör / Conveyor: 475x1560 mm



**SEE-SSO-6405-DO**

HAMUR AÇMA MAKİNESİ / AYAKLI  
DOUGH SHEETER / W STAND

**SEE-SSO-615-AO**

Konveyör / Conveyor: 640x2730 mm



**Nilma**

## SEBZE YIKAMA MAKİNELERİ / MİKSERLER

VEGETABLE WASHING MACHINES / MIXERS



**NIL-MIXER-200**

DEVE BOYNU MİKSER  
MIXER- HOMOGENIZING-  
EMULSIFYING MACHINE

MODEL / NIL-MIXER-200

Kapasite / Capacity: 200 Lt.

1,5 kW

550x930x1700 mm



**NIL-MIXER-500**

DEVE BOYNU MİKSER  
MIXER- HOMOGENIZING-  
EMULSIFYING MACHINE

MODEL / NIL-MIXER-500

Kapasite / Capacity: 500 Lt.

2,2 kW

550x1040x1710 mm



**NIL-ATIRMTIC**

KONVEYÖRLÜ  
SEBZE YIKAMA MAKİNESİ  
CONTINUOUS VEGETABLE WASHER

MODEL / NIL-ATIRMTIC

Tank Kapasite / Capacity: 500 Lt.

Yıkama Kapasite / washing capacity: 400-800  
Kg/h

3000x1000x1230 mm



**NIL-ATIRMTIC-700**

KONVEYÖRLÜ  
SEBZE YIKAMA MAKİNESİ  
CONTINUOUS VEGETABLE WASHER

MODEL / NIL-ATIRMTIC-700

Tank Kapasite / Capacity: 1500 Lt.

Yıkama Kapasite / washing capacity: 700-1500  
Kg/h

4470x1150x1797 mm



**robot coupe®**

## SEBZE DOĞRAMA MAKİNELERİ

VEGETABLE PROCESSORS

CL SERİSİ / SERIES



MODEL	ROB-CL-30	ROB-CL-50	ROB-CL55-2211	ROB-CL60-2325
Robot Coupe MODEL / Code	24432	24440	2211	2325
Ebatlar / Dimensions	340x304x590mm	350x320x590mm	865x396x1272mm	462x770x1353mm
Kapasite(teorik) / Cap. (teoric)	50-200Kg/sa/h	150-500 Kg/saat/ h	400-1200 Kg/saat/h	600-1800 Kg/saat/h
Hız / Speed	1hız/500 dev/dk/rpm	1hız/375 dev/dk/rpm	2hız/375-750 dev/dk/rpm	2hız/375-750 dev/dk/rpm
Güç / Power	500 Watt	550 watt	1100 watt	1500 watt
Voltaj / Voltage	230V/50/1	230V/50/1	400/50/3	400/50/3
Toplam ağırlık / Total weight	13 Kg	19.8Kg	51,3Kg	91,5Kg

**robot coupe®**

## SEBZE DOĞRAMA MAKİNELERİ

### VEGETABLE PROCESSORS



MODEL	ROB-R201XL	ROB-R211XL	ROB-R502-G	R752VV
Robot Coupe MODEL / Code	22570	2129	2382	2115
Ebatlar / Dimensions	220x280x495mm	220x360x445mm	365x280x540mm	365x280x540mm
Kapasite(teorik) / Cap. (teoric)	20 kişilik yemek Meal for 20 person	10-30 kişilik yemek Meal for 10-30 person	30-300 kişilik yemek	200 - 600 kişilik yemek
Hazne kapasitesi / Bowl Cap.	2.9lt	2.9lt	5,9 Lt	7,5 Lt
Hız / Speed	1hız/1500 dev/dk/rpm	1hız/1500 dev/dk/rpm	2hız/750-1500 dev/dk/rpm	Kesicide 300 ila 3500 dev/dak, sebze doğrayıcıda 300 ila 1000 dev/dak.
Güç / Power	550watt	550watt	900 w	1500 w
Voltaj / Voltage	230V/50/1	230V/50/1	400V/50/3	230V/50/1
Toplam ağırlık / Total weight	10.05Kg	12.60Kg	33 kg	40 kg



MODEL	ROB-R401	ROB-R402-2433	ROB-R502	ROB-R652
Robot Coupe MODEL / Code	2425	2433	2483	2136
Ebatlar / Dimensions (BxExY)	320x304x570mm	320x304x590mm	378x347x660mm	378x347x699mm
Kapasite(teorik) / Cap. (teoric)	20-100 kişilik yemek Meal for 20-100 person	20-100 kişilik yemek Meal for 20-100 person	30-300 kişilik yemek Meal for 30-300 person	50-400 kişilik yemek Meal for 50-400 person
Hazne kapasitesi / Bowl Cap.	4.5lt	4.5lt	5.5lt	5.5lt
Hız / Speed	1hız/1500 dev/dk/rpm	2hız/750-1500 dev/dk/rpm	2hız/750-1500 dev/dk/rpm	2hız/750-1500 dev/dk/rpm
Güç / Power	700watt	750watt	1000watt	1200watt
Voltaj / Voltage	230V/50/1	400V/50/3	400V/50/3	400V/50/3
Toplam ağırlık / Total weight	18.5Kg	20.5Kg	30Kg	33.4Kg



robot coupe®

## EL BLENDERLERİ



MODEL	ROB-MP350 ULTRA	ROB-MP-350-COMBI	ROB-MP450	ROB-MP-450-COMBI	ROB-MP450-XL-FWU
Robot Coupe MODEL / Code	34800	34860	34810	34870	34280
Tüp uzunluğu / Tube length	360mm	350mm	460mm	450mm	690mm
Ebatlar / Diensions	725 mm/Ø125mm	Çan/Bell: 725 mm/ Ø125mm Çırpıcı:805mm/Ø125mm	825mm/Ø125mm	Çan/Bell:810 mm/Ø125mm Çırpıcı / Whip:890mm/ Ø125mm	1210mm/Ø175mm
Kapasite(teorik) / Cap. (teoric)	50 ltr	50ltr	100ltr	100 ltr	100 ltr
Hız / Speed	1hız/9500 dev/dk/rpm	Karıştırma 1500-9000de- vir/dk Mix 1500-9000rpm, Whip 250-1500rpm Çırpmada 250-1500 devir/dk	1hız/speed/ 9500 dev/dk/rpm	Karıştırma 1500-9000devir/ dk Çırpmada 250-1500 devir/dk Mix 1500-9000rpm, Whip 250-1500rpm	150-510 devir/dk arası deęişe- bilen hız Variable speed 150-510 rpm
Güç / Power	440 watt	440 watt	500 watt	500 watt	500 watt
Voltaj / Voltage	220-240/50-60/1	220-240/50-60/1	220-240/50-60/1	220-240/50-60/1	220-240/50-60/1
Toplam ağırlık / Total Weight	6.2Kg	7.9Kg	6.3Kg	8.2Kg	8.6Kg



MODEL	ROB-MICROMIX 34900
Güç tek fazlı / Power monophase	2200 Watts
Voltaj / Voltage	230 V
Hız / Speed	1500-14000 rpm
Ebatlar (tüple birlikte) Dimensions With Tube	430 mm
Brüt Ağırlık / Gross Weight	1.4 Kg
Bıçak , Aeromix ( Havaladıcı Mikser ) ve tüp Blade, Aeromix ( Aerator Mixer ) and Tube	165 mm- hepsi paslanmaz çelik / all stainless steel



MODEL	ROB-ROBOTCOOK
Devir / Rpm	100-4500 dk / min.
Güç / Power	Max. Isıtma Gücü Max. Heating Power 1200 W Motor Gücü / Motor Power 1000 Watt Nominal Cihaz Gücü Rated Device Power 1800 Watt
Paslanmaz Çelik Hazne Kapasitesi Stainless Steel Bowl Capacity	3.7 lt
Sıvı Kapasitesi /Liquid Capacity	2.5 lt
Ağırlık (net ve ambalajlı) Weight ( net and brut)	13,5 / 15 Kg



MODEL	INT-KH0001	INT-KH0002	INT-KH0006
Elektrik Girişi:	220-240V 50Hz	220-240V 50Hz	220-240V 50Hz
Devir Hızı	13000	11000	13000
Çırpma Aparatı	360	360	360
Parçalayıcı Aparatı	300	400	300



**robot coupe®**

## DİSK KOLEKSİYONU

DISC COLLECTION



	R 201 / R 211 - R 301 - R 301 ULTRA R 401 - CL 20	R 402	CL 30	DİSKLER / DISCS	R 502 / R 502 V.V. - R 602 R 602 V.V. - CL 50 / CL 50 ULTRA - CL 52 / CL 55 / CL 60
İNCE DİLİMEÇLER / SLICERS				Badem / Almond 0,6 mm	28166
				0,8 mm	28069
	27051	27051		1 mm	28062
	27555	27555		2 mm	28063
	27086	27086		3 mm	28064
	27566	27566		4 mm	28004
	27087	27087		5 mm	28065
	27786	27786		6 mm	
				8 mm	28066
				10 mm	28067
				14 mm	28068
				4 mm pişmiş ürün cooked food	27244
				6 mm pişmiş ürün cooked food	27245
DALGALI RIPPLE	27621	27621		2 mm	27068
				3 mm	27069
				4 mm	27070
RENDELEYİCİLER / GRATERS	27588	27588	27148	1,5 mm	28056
	27577	27577	27149	2 mm	28057
	27511	27511	27150	3 mm	28058
				4 mm	28073
				5 mm	28059
	27046	27046		6 mm	
				7 mm	28016
	27632	27632		9 mm	28060
	27764	27764		Parmesan	28061
	27191	27191		Rostis tipi ürün Rostis type	27164
	27078	27078		0,7 mm Turp	
27079	27079		1 mm Turp / radish	28055	
27130	27130		1,3 mm Turp / radish		
ŞERİT USULÜ KESME / JULIENNE				1x8 mm	28172
				1x30 Soğan/Lahana onion/cabbage	28153
	27599	27599		2x2 mm	28051
	27080	27080		2x4 mm	27072
	27081	27081		2x6 mm	27066
				2x8 mm	27067
				2x10 mm	28173
				3x3 mm	28101
	27047	27047		4x4 mm	28052
	27610	27610		6x6 mm	28053
27048	27048		8x8 mm	28054	



	R 402 - CL 30	DİSKLER / DISCS	R 502 / R 502 V.V. - R 602 R 602 V.V. - CL 50 / CL 50 ULTRA - CL 52 / CL 55 / CL 60
KÜBİK (KUŞBAŞI) KESME EKİPMANLARI IZGARASI+DİLİMLEYİCİ DİSK / DİCING KİT ( 1 DİCING GRID + 1 SLICING DISC)		5x5x5 mm	28110
	27113	8x8x8 mm	28111
	27114	10x10x10 mm	28112
	27298	12x12x12 mm	
		14x14x5 mm (mozzarella)	28181
		14x14x10 mm	28179
		14x14x10 mm	28113
		20x20x20 mm	28114
		25x25x25 mm	28115
		50x70x25 mm (salade)	28180
PARMAK PATATES EKİPMANI / FRENCH FRY KİT	27116	8x8 MM	28134 (1)
	27117	10x10 mm	28135 (1)
		10x16 mm	28158 (1)



■ **KÜBİK ( KUŞBAŞI ) KESME EKİPMANLARI:** 1 kuşbaşı ızgarası + 1 dilimleyici disk / DİCING KİT ( 1 DİCING GRID + 1 SLICING DISC

▲ **FRENCH FRY ( PARMAK PATATES ) KESME EKİPMANLARI:** 1 parmak patates ızgarası + özel parmak patates dilimleyici disk. (1) İtme Kafalı CL 55 ve İtme Kafalı CL 60 üzerinde kullanılamaz.

**FRENCH FRY KİT ( 1 FRENCH FRY GRID + 1 SPECIFIC FRENCH FRY SLICER )**

those kits are not suitable to use with both cl55-cl60 pusher feed head.

#### R 201-R 301 ULTRA İÇİN / FOR R 201-R 301 ULTRA

**Ref. 1946 - 5 diskli takım:** İnce dilimleyiciler 2 mm, 4 mm; rendeleyiciler 2 mm; şerit usulü kesme 4x4 mm, 8x8 mm

Ref. 1946 - 5 disc set: 2mm, 4mm slicers; 2mm grater; 4x4mm, 8x8mm julienne

#### CL50 ULTRA, CL55, CL60 İÇİN / FOR CL50 ULTRA, CL55, CL60

**Ref. 1933 - Restoranlar için 8 diskli takım:** İnce dilimleyiciler 2 mm, 5 mm; rendeleyiciler 2 mm; şerit usulü kesme 3x3 mm, kübik (kuşbaşı) kesme ekipmanı: İnce dilimleyiciler 10 mm+ızgarası 10x10 mm; kızartmış patates ekipmanı: 10x10 mm (2 disk)

Ref. 1933 - 8 disc set: 2mm, 5mm slicers; 2mm grater; 3x3mm julienne; dicing kit : 10mm slicer, 10x10mm grid, french fry kit: special slicer + 10x10mm french fry disc.

#### CL30 BİSTRO İÇİN / FOR CL30 BİSTRO

**Ref. 1945 - CL 30 Bistro için 6 diskli takım:** İnce dilimleyiciler 2 mm, 4 mm; rendeleyiciler 2 mm; şerit usulü kesme 4x4 mm, kübik (kuşbaşı) kesme ekipmanı: İnce dilimleyiciler 10 mm+ızgarası 10x10 mm

Ref. 1945 - 6 disc set for CL 30Bistro : 2mm, 4mm slicers; 2mm grater; 4x4mm julienne; dicing kit :10mm slicers & 10x10mm dicing grid

#### CL50 ULTRA, CL55, CL60 İÇİN / FOR CL50 ULTRA, CL55, CL60

**Ref. 1942 - Topluluklar için 12 diskli takım:** İnce dilimleyiciler 2 mm, 5 mm; rendeleyiciler 2 mm; 5 mm; şerit usulü kesme 4x4 mm, kübik (kuşbaşı) kesme ekipmanı: İnce dilimleyiciler 10 mm+ızgarası 10x10 mm; ince dilimleyiciler 20 mm + ızgarası 20x20 mm; parmak patates ekipmanları: 10x10 mm (2 disk) + duvar tipi disk askısı

Ref. 1942 - 12 disc set: 2mm, 5mm slicers; 2mm, 5mm grater; 3x3, 4x4mm julienne; dicing kit : 10mm slicer , 10x10mm grid, 20 mm slicer, 20x20mm grid, french fry kit : special slicer + 10x10mm french fry grid ; wall type disc holder

#### CL30 BİSTRO İÇİN / FOR CL30 BİSTRO

**Ref. 1909 - CL 30 Bistro için 8 diskli takım:** İnce dilimleyiciler 2 mm, 4 mm; rendeleyiciler 2 mm; şerit usulü kesme 2x2 mm, 2x4 mm; 4x4 mm; kübik (kuşbaşı) kesme ekipmanı: İnce dilimleyiciler 10 mm+ızgarası 10x10 mm

Ref. 1909 - 8 disc set: 2mm, 4mm slicers; 2mm grater; 2x2mm, 2x4mm, 4x4mm julienne; dicing hit : 10mm slicer, 10x10mm grid

#### CL50 ULTRA, CL55, CL60 İÇİN / FOR CL50 ULTRA, CL55, CL60

**Ref. 1943 - Restoranlar için 7 diskli takım:** İnce dilimleyiciler 2 mm, 5 mm; rendeleyiciler 2 mm; şerit usulü kesme 3x3 mm, 4x4 mm; kübik (kuşbaşı) kesme ekipmanı: İnce dilimleyiciler 10 mm+ küp ızgarası 10x10 mm

Ref. 1943 - 7 disc set: 2mm, 5mm slicers; 2mm grater; 3x3mm, 4x4mm julienne; dicing kit : 10mm slicer, 10x10mm mm grid

# BUHAR KONVEKSİYONLU FIRINLAR

## COMBI STEAMERS



### SelfCookingCenter® 5 Senses

 ICC-61/1E  
ICC-61/1G

 ICC-101/1E  
ICC-101/1G

 ICC-102/1E  
ICC-102/1G

 ICC-201/1E  
ICC-201/1G

 ICC-202/1E  
ICC-202/1G

 INT-RF0126  
INT-RF0127

 INT-RF0128  
INT-RF0129

 INT-RF0132  
INT-RF0133

 INT-RF0134  
INT-RF0135

 INT-RF0136  
INT-RF0137

	INT-RF0126 INT-RF0127	INT-RF0128 INT-RF0129	INT-RF0132 INT-RF0133	INT-RF0134 INT-RF0135	INT-RF0136 INT-RF0137
Kapasite / Capacity	6x 1/1 GN	10x 1/1 GN	10x 2/1 GN	20x 1/1 GN	20x 2/1 GN
Günlük yemek / Daily meal	30-100	80-150	150-300	150-300	300-500
Ebatlar / Dimensions	850x775x754	850x775x1014	1072x975x1014	877x847x1807	1802x1052x1807
Ağırlık (elektrikli/gazlı) Weight (electrical/with gas)	95/110 Kg	123/143 Kg	165/187 Kg	246/267 Kg	313/346 Kg
Bağlantı Elektrikli / Connected Load Electric	3 NAC 400V 10,8 Kw	3 NAC 400V 18,9	3 NAC 400V 37,4	3 NAC 400V 37,2	3 NAC 400V 67,9
Bağlantı Gazlı / Connected Load Gas	1 NAC 230V 13 Kw	1 NAC 230V 22 Kw	1 NAC 230V 40 Kw	1 NAC 230V 42 Kw	1 NAC 230V 80 Kw
30C°-130C° buharlı pişirme / steam cooking	✓	✓	✓	✓	✓
30C°-300C° kuru pişirme / dry cooking	✓	✓	✓	✓	✓
30C°-300C° kombi pişirme / combi cooking	✓	✓	✓	✓	✓
iCookingControl- 7 faz / phase	✓	✓	✓	✓	✓
iLevel Control					
(Raf bazlı pişirme) / Multi Level Cooking	✓	✓	✓	✓	✓
HiDensityControl	✓	✓	✓	✓	✓
Otomatik bakım / Care Control	✓	✓	✓	✓	✓
Hızlı Soğutma / Cooldown	✓	✓	✓	✓	✓
Prob ile pişirme / Prob cooking	✓	✓	✓	✓	✓
Delta T pişirme / Delta- T cooking	✓	✓	✓	✓	✓
Dokunmatik panel / Touch Panel	✓	✓	✓	✓	✓
Türkçe menü / Turkish Menu	✓	✓	✓	✓	✓
Otomatik yıkama / Automatic Wash	✓	✓	✓	✓	✓
Fan hızı / Fan Speed	5	5	5	5	5



## BUHAR KONVEKSİYONLU FIRINLAR

COMBI STEAMERS



### CombiMaster® Plus

ICP-61/1E  
ICP-61/1G

ICC-101/1E  
ICC-101/1G

ICC-102/1E  
ICC-102/1G

ICC-201/1E  
ICC-201/1G

ICC-202/1E  
ICC-202/1G



	INT-RF0113 INT-RF0114	INT-RF0115 INT-RF0116	INT-RF0119 INT-RF0120	INT-RF0121 INT-RF0122	INT-RF0123 INT-RF0124
Kapasite / Capacity	6x 1/1 GN	10x 1/1 GN	10x 2/1 GN	20x 1/1 GN	20x 2/1 GN
Günlük yemek / Daily meal	30-100	80-150	150-300	150-300	300-500
Ebatlar / Dimensions	850x775x754	850x775x1014	1072x975x1014	877x847x1807	1802x1052x1807
Ağırlık (elektrikli/gazlı) Weight (electrical/with gas)	100/114 Kg	130/149 Kg	173/192 Kg	254/273 Kg	325/358 Kg
Bağlantı elektrikli /Connected load electric	3 NAC 400V 10,8 Kw	3 NAC 400V 18,9	3 NAC 400V 37,4	3 NAC 400V 37,2	3 NAC 400V 67,9
Bağlantı Gazlı /Connected Load Gas	1 NAC 230V 13 Kw	1 NAC 230V 22 Kw	1 NAC 230V 40 Kw	1 NAC 230V 42 Kw	1 NAC 230V 80 Kw
30C°-130C° buharlı pişirme / steam cooking	✓	✓	✓	✓	✓
30C°-300C° kuru pişirme / dry cooking	✓	✓	✓	✓	✓
30C°-300C° kombi pişirme / combi cooking	✓	✓	✓	✓	✓
Clima PLUS	✓	✓	✓	✓	✓
El duşu / Hand Sprey	✓	✓	✓	✓	✓
Program sayısı / Program number	100	100	100	100	100
Hızlı Soğutma / Cooldown	✓	✓	✓	✓	✓
Prob	✓	✓	✓	✓	✓
Dijital panel / Digital Panel	✓	✓	✓	✓	✓
Manuel yıkama / Manuel Washing	✓	✓	✓	✓	✓
Fan hızı / Fan Speed	5	5	5	5	5

MADE BY  
**SCHOLL**

## İNDÜKSİYONLU PIŞİRİCİLER

### INDUCTION COOKER

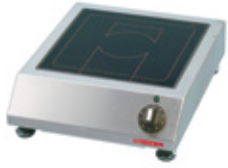

İNDÜKSİYONLU PIŞİRİCİ  
/ SETÜSTÜ  
INDUCTION COOKER  
/ COUNTER TOP

**SHL-BH/BA-3500**



**SHL-FLEX-BASE-3.5**  
**SHL-FLEX-BASE-5**

İNDÜKSİYONLU PIŞİRİCİ  
/ SETÜSTÜ  
INDUCTION COOKER  
/ COUNTER TOP



**SHL-FLEX-BASE-10**

İNDÜKSİYONLU PIŞİRİCİ  
/ SETÜSTÜ  
INDUCTION COOKER  
/ COUNTER TOP

MODEL	SERAN CAM ÖLÇÜLER CERAN FIELD	CİHAZ ÖLÇÜLERİ DIMENSION	KESİM ÖLÇÜLERİ CUTTING SIZES	GÜÇ POWER	WOK ÇAPI WOK DIAMETER
	mm	mm	mm	KW	Ø
SHL-BH/BA-3500	260x260	320x380x105	-	3,5	-
SHL-FLEX-BASE-3.5	372x349	380x460x140	-	3,5	-
SHL-FLEX-BASE-5	372x349	380x460x140	-	5	-
SHL-FLEX-BASE-10	372x609	380x720x140	-	10	-



**SHL-FLEX-WOK-3.5**  
**SHL-FLEX-WOK-5**

İNDÜKSİYONLU WOK PIŞİRİCİ  
/ SETÜSTÜ  
INDUCTION WOK COOKER  
/ COUNTER TOP



**SHL-FLEX-GRIDDLE**

İNDÜKSİYONLU PIŞİRİCİ  
/ SETÜSTÜ  
INDUCTION COOKER  
/ COUNTER TOP

MODEL	SERAN CAM ÖLÇÜLER CERAN FIELD	CİHAZ ÖLÇÜLERİ DIMENSION	KESİM ÖLÇÜLERİ CUTTING SIZES	GÜÇ POWER	WOK ÇAPI WOK DIAMETER
	mm	mm	mm	KW	Ø
SHL-FLEX-WOK-3.5	-	380x473x200	-	3,5	300
SHL-FLEX-WOK-5	-	380x473x200	-	5	300
SHL-FLEX-GRIDDLE	-	531x493x200/356	-	3,5	-



**SHL-SH/DU/IN-3500**

İNDÜKSİYONLU PIŞİRİCİ  
/ ANKASTRE  
INDUCTION COOKER  
/ BUILT-IN



**SHL-SH/WO/IN-3500**

İNDÜKSİYONLU PIŞİRİCİ  
/ ANKASTRE  
INDUCTION COOKER  
/ BUILT-IN



**SHL-SH/IN-3500**

İNDÜKSİYONLU PIŞİRİCİ  
/ ANKASTRE  
INDUCTION COOKER  
/ BUILT-IN

MODEL	SERAN CAM ÖLÇÜLER CERAN FIELD	CİHAZ ÖLÇÜLERİ DIMENSION	KESİM ÖLÇÜLERİ CUTTING SIZES	GÜÇ POWER	WOK ÇAPI WOK DIAMETER
	mm	mm	mm	KW	Ø
SHL-SH/DU/IN-3500	320x580	384x644x155	345x605	2x3,5	-
SHL-SH/WO/IN-3500	-	384x384x297	-	3,5	306
SHL-SH/IN-3500	320x320	384x384x226	320x320	3,5	-



**salva**

## MODÜLER FIRINLAR

.....  
MODULAR COOKER

MODEL	TANIM DESCRIPTION	GÜÇ POWER	AĞIRLIK WEIGHT
SAL-BASE/EM	Taban/tavan ilavesi / Base/top	-	30/50 Kg
SAL-EM/SOLERA	Taş taban ilavesi / Stone floor add	-	-
SAL-EM20	Pişirme Modülü / Module	4,9kw	141 Kg
SAL-EM20-VAPOR	Pişirme Modülü,buharlı ,taş taban dahil Module, with steam and stone sole	6,3kw	187 Kg
SAL-EM20-PIZZA	Pişirme modülü,taş taban dahil Modul, with stone sole	6,2kw	155 Kg
SAL-ESTUFA EM/13	Mayalama dolabı,nemlendirmeli Proofer with humidity	1kw	108 Kg
SAL-SOPORTE/EM-435 SAL-SOPORTE/EM-530 SAL-SOPORTE/EM-630"	Tekerlekli fırın standı / Stand with castors	-	-



### AÇIKLAMA / DESCRIPTION

İç Ölçüler / Interior Dimensions 817x669 mm

İç Yükseklik / Chamber Height 200 mm

Kapasite: 60x40-2 Tepsi/Modül Capacity: 60x40-2 2 Tray / Module

salva

## MODÜLER FIRINLAR

MODULAR OVENS



MODEL	TANIM DESCRIPTION	GÜÇ POWER	AĞIRLIK WEIGHT
SAL-BASE/EMD	Taban/tavan ilavesi / Base/top	-	50/73 Kg
SAL-EMD/SOLERA	Taş taban ilavesi / Stone floor add	-	-
SAL-EMD20	Pişirme Modülü / Module	9,1kw	199 Kg
SAL-EMD20-VAPOR	Pişirme Modülü,buharlı ,taş taban dahil Module, with steam and stone sole	11,6kw	270 Kg
SAL-EM2D0-PIZZA	Pişirme modülü,taş taban dahil" Modul, with stone sole	11,5 kw	277 Kg
SAL-ESTUFA EMD/13	Mayalama dolabı,nemlendirmeli Proofer with hummidity	1kw	139 Kg
SAL-SOPORTE/EMD-435 SAL-SOPORTE/EMD-530 SAL-SOPORTE/EMD-630	Tekerlekli fırın standı / Stand with castors	-	-

## AÇIKLAMA / DESCRIPTION

İç Ölçüler / Interior Dimensions 1117x869 mm

İç Yükseklik / Chamber Height 200 mm

Kapasite: 60x40-4 Teps/Modül Capacity: 60x40-4 Tray / Module



**salva**

# MODÜLER FIRINLAR

.....  
MODULAR OVENS

MODEL	TANIM DESCRIPTION	GÜÇ POWER	AĞIRLIK WEIGHT
SAL-BASE/E	Taban/tavan ilavesi / Base/top	-	45/65 Kg
SAL-E/SOLERA	Taş taban ilavesi / Stone floor add	-	-
SAL-E20	Pişirme Modülü / Module	7,8 kw	168 Kg
SAL-E20-VAPOR	Pişirme Modülü,buharlı ,taş taban dahil Module, with steam and stone sole	9,2 kw	236 Kg
SAL-E20-PIZZA	Pişirme modülü,taş taban dahil Modul, with stone sole	9,8 kw	185 Kg
SAL-E30	Pişirme Modülü / Module	9,8 kw	208 Kg
SAL-E30-VAPOR	Pişirme Modülü,buharlı ,taş taban dahil Module, with steam and stone sole	11,2 kw	256 Kg
SAL-ESTUFA E/13	Mayalama dolabı,nemlendirmeli Proofer with hummidity	1kw	108 Kg
SAL-SOPORTE/E-435 SAL-SOPORTE/E-530 SAL-SOPORTE/E-630"	Tekerlekli fırın standı / Stand with castors	-	-



## AÇIKLAMA / DESCRIPTION

İç Ölçüler / Interior Dimensions 1217x669 mm

İç Yükseklik / Chamber Height E-20: 200 mm E-30: 300 mm

Kapasite: 60x40-3 Tepsi/Modül Capacity: 60x40-3 Tray / Module

**salva**

# MODÜLER FIRINLAR

.....  
MODULAR OVENS



MODEL	TANIM DESCRIPTION	GÜÇ POWER	AĞIRLIK WEIGHT
SAL-BASE/ED	Taban/tavan ilavesi / Base/top	-	45/65 Kg
SAL-ED/SOLERA	Taş taban ilavesi / Stone floor add	-	-
SAL-ED20	Pişirme Modülü / Module	7,8 kw	168 Kg
SAL-ED20-VAPOR	Pişirme Modülü,buharlı ,taş taban dahil Module, with steam and stone sole	9,2 kw	236 Kg
SAL-ED30	Pişirme Modülü / Module	9,8 kw	208 Kg
SAL-ED30-VAPOR	Pişirme Modülü,buharlı ,taş taban dahil Module, with steam and stone sole	11,2 kw	256 Kg
SAL-SOPORTE/ED-435 SAL-SOPORTE/ED-530 SAL-SOPORTE/ED-630	Tekerlekli fırın standı / Stand with castors	-	-



## AÇIKLAMA / DESCRIPTION

İç Ölçüler / Interior Dimensions 1217x269 mm

İç Yükseklik / Chamber Height ED-20: 200 mm ED-30: 300 mm

Kapasite: 60x40-6 Tepsiler/Modül Capacity: 60x40-6 Tray / Module



# NARENCİYE SIKMA MAKİNELERİ CITRUS JUICERS



## SAN-N-10

NARENCİYE SIKMA MAKİNESİ  
CITRUS JUICER

### MODEL / SAN-N-10

Kollu / With lever  
Otomatik / Automatic

Boyalı Gövde / Painted Body

Kapasite / Capacity: 30 lt/h

300x200x380 mm



## SAN-N-11

NARENCİYE SIKMA MAKİNESİ  
CITRUS JUICER

### MODEL / SAN-N-11

Boyalı Gövde / Painted Body

3 Farklı Ebatla Sıkma Kafası  
3 Type of Citrus Cone

Kapasite / Capacity: 30 lt/h

300x200x350 mm



## SAN-N-32T

PORTAKAL SIKMA MAKİNESİ  
ORANGE JUICERS

### MODEL / SAN-N-32T

Otomatik / Automatic

Kapasite / Capacity: 100 lt/h

845x410x1816 mm



## SAN-N-33

BAR BLENDER

### MODEL / SAN-N-33E

Boyalı Gövde / Painted Body

1,25 Lt.

Polikarbonat Konteynerli  
Polycarbonate Container



## SAN-N-37-2LP

MİKSER  
MIXER

### MODEL / SAN-N-37-2LP

Boyalı Gövde / Painted Body

2 Lt.

Polikarbonat Konteynerli  
Polycarbonate Container

230x215x615



## SAN-N-28

KATI MEYVE-SEBZE SIKMA MAKİNESİ  
JUICE EXTRACTOR

### MODEL / SAN-N-28

Paslanmaz Gövde ve Hazne  
Stainless Steel Body / Bowl

Kapasite / Capacity: 100 lt/h

456x330x510 mm



## SAN-N-50

KATI MEYVE-SEBZE SIKMA  
MAKİNESİ  
JUICE EXTRACTOR

### MODEL / SAN-N-50

Boyalı Gövde / Painted Body

Kapasite / Capacity: 100 lt/h

470x260x450 mm



## SAN-N-62

BAR BLENDER

### MODEL / SAN-N-62

Brushless Motor

200x247x440 mm



## SAN-N-65

COLD PRESS KATI  
MEYVE-SEBZE SIKMA MAKİNESİ  
COUNTER TOP COLD PRESS JUICER FOR FRUITS, VEGEES AND LEAFY  
GREENS

### MODEL / SAN-N-65

Paslanmaz Gövde  
Stainless Steel

Kapasite / Capacity: 60 lt/h

**Animo**

**FİLTRE KAHVE  
MAKİNELERİ**

FILTER COFFEE



**ANI-M-100**

MANUEL DOLDURMALI  
MANUEL FILLING

ANI-M-100

Kapasite / Capacity: 144 fin./cup/h/sa

205x380x625h



**ANI-M-200**

SU BAĞLANTILI  
WITH WATER CONNECTION

ANI-M-200

Kapasite / Capacity: 144 fin./cup/h/sa

205x380x625h



**INT-KH0003**

MANUEL DOLDURMALI  
MANUEL FILLING

INT-KH0003

Kapasite / Capacity: Kapasite 144 fin./cup/h/sa

190X370X502



**ANI-CB-2X10**

COMBI MODEL

ANI-CB-2X10

Kapasite / Capacity: 60 Lt./h, 2 Konteynerli /  
With Container

Zaman ayarlı / Timer  
907x465x785 h



**ANI-CB-2X20**

COMBI MODEL

ANI-CB-2X20

Kapasite / Capacity: 90 Lt./h, 2 Konteynerli /  
With Container

Zaman ayarlı / Timer  
1015X500X890 h



# ESPRESSO KAHVE MAKİNELERİ

## ESPRESSO COFFEE MACHINES



ÖZELLİKLER / FEATURES	FAE-E71E-A2	FAE-E71E-A3
Grup sayısı / Groups	2	3
Buhar kolu / Steam Wands	2	2
Sıcak su kolu + seçenek / Hot water wands and selections	1+3temp	1+3temp
Boyer kapasitesi (litre) / Boiler Capacity ( litres)	7	7
Bağımsız Boyer Sayısı / Independent Coffee Boiler	2	3
Her grup için bağımsız boyer kap. (lt) / Capacity of each independent coffee boiler ( lt)	0,6	0,6
Genişlik (mm) / Width	794	1034
Derinlik (mm) / Dept	619	619
Yükseklik (mm) / Height	484	484
Ağırlık (Kg) / Weight	71	90
Güç / Supply Power (415-380V3N60/50-Hz(kW))	6,2 - 7,4	7,5 - 8,8
Prob Gösterge ekranı / Digital Panel	-	-

### AÇIKLAMA

Barista yaratıcılığı ile E71 in üstün mekanizmasının bulunduğu en can alıcı bölüm, E71 in yeni dizayn gruplarıdır. Bağımsız gruplar sayesinde E71 birçok kahve çeşidini, optimum özütleme için herbirinin ihtiyaç duyduğu farklı sıcaklıkları hesaba katarak yapar. Yeni GTI-FAEMA kontrol sistemi sayesinde kahve infüzyon zamanlama yönetimini mükemmel yapar; aynı anda yüksek termal istikrar ve her kahvenin kendine has duyuşal özelliklerini kombine eder. Her bir gruba özel ergonomik ve sezgisel ekran ile E71 ile kahve yapmak çok daha kolay hale gelmiştir. Manuel ve dijital kontrol sistemleri her fincanda kişiselleştirilebilen demleme kontrolü ve dokunmatik ekran ile otomatik dağıtım sağlar. Buhar kolu soğuk kalarak kullanım ve sonrası temizlik işlemlerinde kolaylık sağlar. Barista kolay kullanımı için kollar açılı ve ergonomik olarak özel dizayn edilmiştir.

### DESCRIPTION

The new design of the groups is very essence of the machine, the point at which the barista's ideas meet the mechanics of the new E71E. Thanks to the independent groups, the E71 can manage different coffee varieties, respecting the specific temperatures of each one for optimal extraction. Additionally the hydraulic circuit with a GTI control system guarantees perfect management of coffee infusion times: a perfect combination for simultaneously ensuring high thermal stability and enhancement of each coffee's sensory profile. And thanks to the ergonomic and intuitive display dedicated to each of the groups, it is even simpler to interact with the E71E. Electromechanical pushbutton panel with 3 or 5 backlit buttons positioned on an inclined plane for intuitive, immediate and ergonomic interaction with the machine. The OLED displays show the group temperature as well as the infusion and dispensing times. For the new Faema E71E, long, articulated cold touch wands have been designed to improve the machine's ergonomics and simplify the barista's work.



# ESPRESSO KAHVE MAKİNELERİ

## ESPRESSO COFFEE MACHINES



### Yarı -otomatik espresso kahve makinesi Semi-automatic espresso coffee machines

Her grupta 1 adet sürekli akıtma / durdurma düğmesi mevcuttur.  
Paslanmaz sıcak su kolu ( sürekli akıtma)  
Otomatik boiler dolum  
Each group features one continuous delivery/stop push button.  
Stainless steel hot water wand( continuous delivery)  
Automatic boiler fill

E98 RE S

THEO 64 TEMP

### Otomatik espresso kahve makinesi Automatic espresso coffee machines

Her grupta programlanabilir dozajlama için 4 adet doz seçenek düğmesi ve 1 adet sürekli akıtma / durdurma düğmesi mevcuttur.Paslanmaz sıcak su kolu (kapalı akıtma-1 kol seçimi ) Otomatik boiler dolum

Each group features 4 selections with programmable shot dosing and one continuous delivery/stop push button .Stainless steel hot water wand( closed delivery-1 lever selection) Automatic boiler fill

E98 RE A

THEO 64 AUT



ÖZELLİKLER / FEATURES	FAE-E98UP-S2	FAE-E98UP-A2	FAE-ME-A
Otomatik / Automatic	-	√	-
Yarı-Otomatik / Semi-Automatic Machine	√	-	-
Grup Sayısı / Groups	2	2	-
Buhar Kolu / Steam Wands	2	2	-
Boyer Kapasitesi(litres) / Boiler Capacity ( litres)	11	11	-
Üretim Kapasitesi (GR/SN) /Output ( G/S)	-	-	2,3
Silo Kapasitesi / Hopper Capacity (Kg)	-	-	2
Genişlik (mm) / Width	770	770	260
Derinlik (mm) / Dept	510	510	470
Yükseklik (mm) / Height	485	485	640
Ağırlık (Kg) / Weight	67	67	15
Güç/Supply Power (240-220V60/50-Hz (kW)	4,3-5,0	4,3-5,0	-
Güç/Supply Power (415-380V3N60/50-Hz(kW)	-	-	300
Gaz Isıtmalı / Gas Heating	zz	Opsiyonel /opt	-



**SÜPER OTOMATİK  
ESPRESSO  
KAHVE MAKİNELERİ**

**.....  
SUPER AUTOMATIC  
ESPRESSO COFFEE MACHINES**



**Superotomatik Espresso Kahve Makinesi / Superautomatic Espresso Coffee Machine**

Kullanıcı dostu süperotomatik espresso cappuccino kahve makinesi aynı zamanda toz kakao ve sıcak/soğuk süt ile de işlem yapabildiğinden çok geniş bir içecek menüsü sunar. "10.4" dokunmatik ekran ile kolay kullanım sağlar. 24 farklı çeşide kadar içecek seçeneği sunar. "Patentli Smart Boiler teknolojisi ile maksimum boylar verimi sağlar." Cappuccino System ile tek dokunuşta cappuccino ve latte sunar. Milk Precision System (MilkPS) özel fonksiyonu sayesinde sütü istmadan köpürtme imkanı sunar. 1 Buhar kolu ve 1 teflon kaplı sıcak su kolu mevcuttur. 2 öğütücü - dozajlayıcı daki yüksek performanslı öğütme dişlileri titanyum kaplıdır. PGS ( Kusursuz Öğütme Sistemi) AWS ( Otomatik yıkama sistemi) AWS ( Otomatik yıkama sistemi) Çift yönlü Wi-Fi bağlantısı ve USB bağlantı noktası.

"User friendly superautomatic espresso and cappuccino coffee machine able to offer a varied menu also thanks to the use of soluble cocoa, hot and cold milk (snow milk)" "10.4" touch screen for an easy machine use. Up to 24 drink selections. Pre-selection mode available. Equipped with the patented Smart Boiler technology. Cappuccino System for one-step cappuccino and latte Milk Precision System (MilkPS) allows with a special function allows frothing milk without heating it. 1 Steam wand and 1 teflon coated hot water wand (dosed delivery) 2 grinder dosers featuring titanium coated high performance grinding burrs. PGS ( Perfect Grinding System) AWS ( Automatic Washing System) Bi-directional Wi-Fi connectivity and USB port."

**FAE-X-30CS10**

**Süt Soğutucu / Refrigerated Unit**

Kompresörlü soğutucu 8 litreye kadar süt saklama kapasitesi Dijital termostat, ON/OFF fonksiyonu, Süt sıcaklığı okuma ve ayarlama (+/- 0,1°). "Ebatlar ( WxDxH) (mm) : 290x453x738 Güç 220-240V 50Hz (W) : 360 "

Refrigerated unit with a real compressor. Preserves up to 8 litres of milk. Digital thermostat: ON/OFF function; milk temperature re-ading and setting (+/- 0,1°)." Dimensions ( WxDxH)(mm) : 290x453x738 Power at 220-240V 50Hz (W) : 360 "

**FAE-X-30MILKREF**

**Fincan Isıtıcı / Cupwarmer**

Elektrikli fincan ısıtıcı Fincanları ısıtmek için opsiyonel çıkabilir tel sepetler Sıcaklık ayarlama fonksiyonu Ebatlar ( WxDxH)(mm) : 290x435x738. Güç 220-240V 50Hz (W) : 230 "

Dimmer to control the temperature. Electric cup warming unit. Removable wire baskets, where to store the cups (upon re-quest). Dimensions ( WxDxH)(mm) : 290x435x738 Power at 220-240V 50Hz (W) : 230 "

**FAE-X-30CUPHEAT**

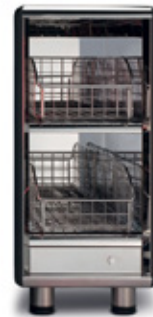







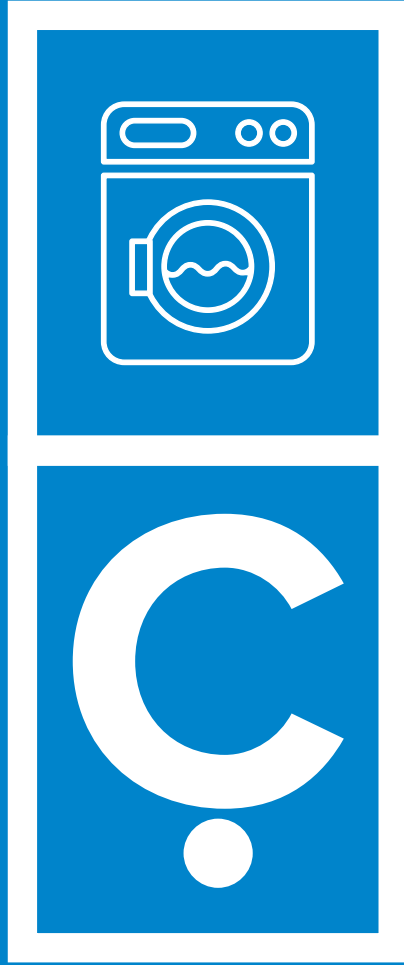

Çamaşırhane Makineleri  
ve Ekipmanları

Laundry Equipment



# ÇAMAŞIRHANE MAKİNELERİ VE EKİPMANLARI

LAUNDRY  
EQUIPMENT





- Free standing yüksek sikma devirli makineler
- Süspansiyonlu sistem sayesinde tüm zeminlerde ve tüm katlarda kullanıma uygundur.
- Standart frekans kontrollü motor
- AİRES programı ile 15 farklı program kapasitesi (5x hassas program, 4x standart program 4x ECO program 2x sikma programı). Ayrıca ilave programlama yapabilme imkanı 28 farklı dil seçeneği (Türkçe dahil)
- İsteğe bağlı jeton mekanizması ve önden deterjan haznesi
- Elektrikli / buharlı / Dual (buhar+elektrik) ısıtma seçeneği
- Yüksek endüstriyel kullanım için üst ve ön paneller paslanmazdır.
- Su, enerji, deterjan ve zaman tasarrufu sağlayan YENİ "SMARTWAVE" özelliği ( kabin için konan tekstil türüne ve su tutma kapasitesine göre su ve deterjan miktarını otomatik belirler.)
- Freestanding , high-spin (up to 1165 RPM/400 G factor-İY65 and İY80)
- Stainless steel top and front panel, black side panels
- SMARTWAVE-technology reduces water , energy, detergent and time
- Stainless steel drum and tub
- Easy to use Aries programmer or Fully programmable Aries Elite
- Patented soap hopper
- Large drain valve ( Ø76mm/3in)
- Easy access to all vital parts from the front
- Large door opening for easy loading and unloading .



### YÜKSEK SIKMA DEVİRLİ YIKAMA - SIKMA MAKİNELERİ / 7 -28 Kg. SEFER YIKAMA KAPASİTESİ HIGH EFFICIENT SOFTMOUNT WASHER-EXTRACTORS / Capacities : 7-28 Kg

**IPS-IY**

Belirtilen fiyatlar elektrik ısıtmalı, standart donanımlı cihazlar için verilmiş olup, diğer opsiyonlar için fiyat alınması gerekmektedir.  
Indicated prices are for electric heating , standart equipped models. It is necessary to ask price for the other options.

IPS-IY		IPS-IY 65	IPS-IY 80	IPS-IY 105	IPS-IY 135	IPS-IY 180	IPS-IY 240	IPS-IY 280
Tambur Kapasitesi Drum Capacity	Kg	7	8	11	14	18	24	28
Tambur Hacmi /Drum Volume	lt	65	75	105	135	180	240	280
Tambur çapı / Drum Diameter	mm	530	530	620	620	750	750	750
G-Kuvvetli / G-Force		350	350	350	350	350	350	350
Yıkama / Sikma Hızı Washing / Drying Speed	rpm	49/1165	49/1165	49/1075	49/1075	42/980	42/980	42/915
Elektrik Isıtmalı (Standart) Electric Heating (Standard)	kW	6	6	9	12	12	18	22
Net Ölçüler / net Dimensions	Boy/Width mm	710	710	795	795	970	970	970
	Derinlik/Dept mm	740	790	795	945	970	1105	1185
	Yükseklik/Height mm	1115	1115	1225	1225	1410	1410	1410
Net Ağırlık / Net Weight	Kg	170	185	210	255	380	430	495
Brüt Ağırlık / Gross Weight	Kg	180	200	235	275	395	450	515
Su Girişleri / Water Inlets	BSP	3/4"	3/4"	3/4"	3/4"	3/4"	3/4"	3/4"
Ses Seviyesi / Noise Level	dB(A)	<65	<65	<65	<65	<65	<65	<65
Buhar Girişleri / Steam Inlets	BSP	1/2"	1/2"	1/2"	1/2"	1/2"	1/2"	1/2"
Buhar Basıncı / Steam Pressure	kPa	100-800	100-800	100-800	100-800	100-800	100-800	100-800
Drenaj Çıkışı / Drain Outlet	Q mm	76	76	76	76	76	76	76
Su Basıncı / Water Pressure	kPa	100-800	100-800	100-800	100-800	100-800	100-800	100-800



- Free standing makine, kaideye gerek kalmadan montaj özelliği
- Standart frekans kontrollü motor
- ARIES ELITE programı ile yüklenmiş 20 farklı program mevcuttur. (5X hassas program , 4X standart programı, 4X eco program, 2 sıkma programı, 5X özel program) ve 60 programa kadar sonradan programlanabilir. Türkçe dahil 21 farklı dil seçeneği mevcuttur.
- Yıkama programları isimlerini programlanan dilde geniş LCD ekranında gösterme.
- Eco buton özelliği ile su tüketimini minimum seviyeye düşürme. Test programı sayesinde hata belirleyebilme
- Kolay yükleme ve boşaltma için geniş kapı
- IY450, IY600, IY800, IY1000, IY1200 (one way tilting) kolay boşaltma için öne yatabilme özelliği opsiyonel

- Freestanding , high-spin
- Stainless steel drum and tub
- SMARTWAVE-technology reduces water , energy, detergent and time
- Aries Elite - fully programmable microprocessor
- Large door opening for easy loading and unloading
- Large drain valves 2xØ76mm/3 in or 2x Ø103mm/4in
- Easy access to all vital parts from the front
- User friendly control position regardless user's height
- Perforated lifting ribs : More mechanical action
- Eco washing programs : Significantly reduces water and electricity consumption



## YÜKSEK DEVRİMLİ YIKAMA - SIKMA MAKİNELERİ / 35-120 Kg. SEFER YÜKLEME KAPASİTESİ HIGH EFFICIENT SOFTMOUNT WASHER-EXTRACTORS / Capacities : 35-120 Kg

**IPS-IY**

Belirtilen fiyatlar elektrik ısıtmalı, standart donanımlı cihazlar için verilmiş olup, diğer opsiyonlar için fiyat alınması gerekmektedir.  
Indicated prices are for electric heating , standart equipped models. It is necessary to ask price for the other options.

IPS-IY		IPS-IY 350	IPS-IY 450	IPS-IY 600	IPS-IY 800	IPS-IY1200-S	IPS-IY 1200 S
Tambur Kapasitesi Drum Capacity	Kg	35	45	60	80	100	120
Tambur Hacmi /Drum Volume	lt	350	450	600	807	1005	1180
Tambur çapı / Drum Diameter	mm	Ø 914	Ø 914	Ø 1035	Ø 1110	Ø 1200	Ø 1300
G-Kuvveti / G-Force		360	360	360	350	350	350
Yıkama / Sıkma Hızı Washing / Drying Speed	rpm	38/830	38/830	36/780	36/750	33/720	32/695
Bağımsız Programlama Independent Programming	ARIES ELITE	std.	std.	Standart			
Net Ölçüler Net Dimensions	Boy/Width mm	1315	1315	1315	1495	1790	1855
	Derinlik/Dept mm	1270	1502	1502	1940	2005	2085
	Yükseklik/Height mm	1925	1925	1925	1985	2060	2085
Net Ağırlık / Net Weight	Kg	1010	1350	1500	2640	3170	3480
Brüt Ağırlık / Gross Weight	Kg	1150	1490	1640	2830	3410	3710
Su Girişleri / Water Inlets	mm	3 x 25	3 x 25	3 x 25	3x38	3x38	3x38
Buhar Girişleri / Steam Inlets	mm	-	-	-	25	25	25
Buhar Basıncı / Steam Pressure	Bar.	-	-	-	3-8	3-8	3-8
Drenaj Çıkışı / Drain Outlet	mm				2x103	2x103	2x103
Isıtma Türü / Heating Type		Elektrik	Elektrik	Elektrik	Elektrik	Buhar	Buhar
Güç / Power		24kW	36kW	54kW	67,5kW	-	-



- Hard mount (Ankarajlı montaj) sistem yıkama makineleri (Ara katlar için uygun değildir)
- Yüksek devirli makinelere göre fiyat yönünden avantajlı
- Kolay yükleme ve boşaltma için geniş kapı açılımı
- ARIES programı ile 15 farklı program kapasitesi (5X hassas program, 4X standart program, 4X Eco program, 2X sıkma programı) Ayrıca ilave program yapabileme imkanı, 28 farklı dil seçeneği (Türkçe dahil)
- Smartwave özelliği

- Hard mount washer extractors ( suitable for base floors)
- Normal ( 100 G) and Medium(175 G) extraction force
- Stainless steel top and front panel , black side panels
- Stainless steel drum and tub
- SMARTWAVE -technology reduces water, energy, detergent and time
- Standart Easy to use Aries programmer. Fully programmable Aries Elite as an option
- Patented soap hopper
- Large drain valve 76 mm/3 in diameter. Two on 35 Kg/77 lb and 52 Kg/114 lb washers .
- Easy access to all vital parts
- Large door opening for easy loading and unloading.



**NORMAL SIKMA DEVİRLİ YIKAMA - SIKMA MAKİNELERİ / 8-52 Kg. SEFER YIKAMA KAPASİTESİ**  
**HIGH EFFICIENT HARDMOUNT WASHER-EXTRACTORS / Capacities : 8-52 Kg**

IPS-IA

Belirtilen fiyatlar elektrik ısıtmalı, standart donanımlı cihazlar için verilmiş olup, diğer opsiyonlar için fiyat alınması gerekmektedir.  
 Indicated prices are for electric heating , standart equipped models. It is necessary to ask price for the other options.

IPS-IA		IPS-IA 80	IPS-IA 105	IPS-IA 135	IPS-IA 180	IPS-IA 240	IPS-IA 280	IPS-IA 332	IPS-IA 520
Tambur Kapasitesi Drum Capacity	Kg	8	11	14	18	24	28	35	52
Tambur Hacmi /Drum Volume	lt	75	105	135	180	240	280	332	520
Tambur çapı / Drum Diameter	mm	530	620	620	750	750	750	919	914
G-Kuvetli / G-Force		100	100	100	100	100	100	100	100
Yıkama / Sıkma Hızı Washing / Drying Speed	rpm	50/580	46/540	46/540	42/490	42/490	42/490	38-540	38/440
Bağımsız Programlama Independent Programming	Boy/Width mm	660	750	750	890	890	890	1088	1088
Net Ölçüler Net Dimensions	Derinlik/Dept mm	785	785	900	915	1060	1135	1060	1345
	Yükseklik/Height mm	1115	1225	1225	1410	1135	1410	1625	1625
	Kg	135	170	190	255	275	290	410	520
Net Ağırlık / Net Weight	Kg	145	185	200	270	290	305	450	570
Brüt Ağırlık / Gross Weight	BSP	1/2"	1/2"	1/2"	1/2"	1/2"	1/2"	3/4"	3/4"
Buhar Basıncı / Steam Pressure	kPa	100-800	100-800	100-800	100-800	100-800	100-800	100-800	100-800
Drenaj Çıkışı / Drain Outlet	ø mm	76	76	76	76	76	76	2x76	2x76
Ses Seviyesi / Noise Level	dB(A)	<65	<65	<65	<65	<65	<65	<65	<65
Su Basıncı / Water Pressure	kPa	100-800	100-800	100-800	100-800	100-800	100-800	100-800	100-800



- Hastane, cezaevi ve benzer yerlerde hijyenik yıkama istenilen yerler için üretilmiş bariyerli yıkama makineleri
- Çift kapılı (kili ve temiz taraf ayrılmıştır)
- IH modellerde ARIES ELITE programı ile yüklenmiş 20 farklı program mevcuttur. (5x hassas yıkama, 4x standart program, 4x eco program, 2x sıkma programı, 5x özel program) ve 60 programa kadar ilave programlama yapabilme imkanı. Türkçe dahil 21 farklı dil seçeneği mevcuttur.
- Sıvı deterjan kullanabilme programı ( 8 pompa bağlayabilme )
- Kolay yükleme boşaltma için geniş kapı açıklığı
- Elektrik/buhar ısıtmalı
- Smart wave

• **Barrier washer extractors  
IH series with capacities 18-28 Kg**

- Freestanding, high spin,
- Complete stainless steel cabinet ,
- Stainless steel drum and tub
- SMARTWAVE-technology reduces water, energy, detergent and time ,
- Aries Elite - fully programmable
- Large drain valve (Ø76mm/3 in),
- Easy access to all important parts from all sides,
- Liquid soap connection

• **Barrier washer-extractors IMB series with capacities 36-70 Kg**

- Freestanding, high spin,
- Oversized frame, bearings and drum ,
- Large drain valve 2 x Ø76 mm
- Easy access to all parts,
- Frequency controlled motor,
- Large door opening for easy loading and unloading. ,
- Aries Elite - new graphic display with almost unlimited possibilities:
- Freely programmable, Multilingual
- Perforated lifting ribs: better washing results, lower water consumption,
- Eco-friendly washing programs - significantly reduces water and
- Electricity consumption ,
- Soap dispenser with 5 removable compartments
- Designed with focus on ergonomiy

**YÜKSEK DEVİRLİ HİJYENİK YIKAMA - SIKMA MAKİNELERİ /** IH serisi 18-28 Kg/sefer yükleme kapasitesi (Bariyerli) / IMB serisi 36-70 Kg/sefer yükleme kapasitesi  
**BARRIER WASHER-EXTRACTORS /** IH series Capacities:18-28 Kg- IMB series Capacities:36-70 Kg

**IPS-IH/IMB**

IPS-IH/IMB		IPS-IH 180	IPS-IH 240	IPS-IH 280	IPS-IMB 360	IPS-IMB 500	IPS-IMB 700
Tambur Kapasitesi Drum Capacity	Kg	18	24	28	36	50	70
Tambur Hacmi /Drum Volume	lt	180	240	280	332	442	663
Tambur çapı / Drum Diameter	mm	ø 750	ø 750	ø 750	ø 650	ø 750	2X ø 750
G-Kuvveti / G-Force	Adet	1	1	1	1	1	2
Yıkama / Sıkma Hızı Washing / Drying Speed		370	370	350	335	350	350
Yıkama/Sıkma Hızı	rpm	42/939	42/939	42/914	45/960	41/915	41/915
Program / Programme		Ares Elite	Ares Elite	Ares Elite	MICRO	MICRO	MICRO
Elektrik Isıtmalı / Electric Heating	kW	12	18	21,9	36	45	54
Buhar Basıncı / Steam Pressure	bar	3-8	3-8	3-8	3-8	3-8	3-8
Su Girişleri / Water Inlets	mm	3x19	3x19	3x19	25	25	25
Buhar Girişleri / Steam Inlets	mm	13	13	13	19	19	19
Net Ölçüler / Net Dimensions	Boy/Width mm	900	1020	1130	1560	1610	2160
	Derinlik/Dept mm	1145	1145	1145	1060	1170	1170
	Yükseklik/Height mm	1455	1455	1455	1600	1650	1650
Ağırlık / Weight	Kg	430	460	490	1000	1140	1360

NOT: Belirtilen modellerin dışında 90, 110, 140 ve 180 Kg kapasiteli modellerde mevcuttur. Lütfen fiyat isteyiniz. Belirtilen fiyatlar standart donanımlı elektrik ısıtmalı cihazlar için verilmiştir.

Note : Indicated prices are for electric heating , standart equipped models. It is necessary to ask price for the bigger capacity 90,110,140 and 180 Kg machines .



---

# ÇAMAŞIR KURUTMA MAKİNELERİ

.....

LAUNDRY DRYING  
MACHINES



- Galvaniz tambur, emaye kabin
- Geniş yükleme kapısı ve emniyet sistemi
- Reverse (sağ-sol dönüş) DR120, DR170, DR200 standarttır.
- Dx4 program modeli sayesinde 3 adet kurutma programı
- Elektrik/ Buhar/gaz ısıtma sistemi
- Opsiyonel jeton mekanizması
- Opsiyonel nem kontrollü program kartı
- Opsiyonel olan kontrol sistemi sayesinde "Fazla Kurumayı Önleme Teknolojisi" ve 30 farklı kurutma programı.
- DR 120 ve DR 170 ve DR 200 modellerde OPT kontrol sistemi standarttır.
- Tamburu destekleyen ön destek sistemi.
- "Single tumble dryers with drum volume 217-1656 litres
- Large door opening for easy loading and unloading, • Standard galvanized drum (Stainless steel as an option)
- Unique drum supporting system , • Large lint filter , • Axial airflow (DR25, 30, 35, 55S)
- Radial airflow (DR50, 75, 120, 170, 200) ,
- Control offering:
- - OPL: Dual Digital Timer or OPTimum control
- - Vend: EV07S
- Overdry-Prevention-Technology (OPT) reduces drying time, utility
- & labour cost and extends linen life
- Standard frequency inverter drive
- Standard reversing on DR120, 170, 200. Optional on other models.
- Option „ECOdry“ on DR25, 30, 35, 50, 55S, 75"

#### 10,9-82,8 Kg / SEFER YÜKLEME KAPASİTESİ / LOADING CAPACITY

Belirtilen fiyatlar elektrik ısıtmalı, galvaniz tamburlu ve standart donanımlı cihazlar için verilmiş olup, paslanmaz tambur ve diğer opsiyonlar için fiyat alınması gerekmektedir. Indicated prices are for electric heating , galvanized drum , standart equipped models. It is necessary to ask price for stainless steel drum and the other options.

DR 170 ve DR200 modelinin elektrik ısıtmalı versiyonu bulunmamaktadır. Gaz ve buhar ısıtma mevcuttur.

\* Belirtilen fiyat gaz ısıtmalı cihaz için geçerlidir. (DR 170 ve DR 200 için) . There is no electric heating version available for DR170 and DR200 . Gas and steam heating models available for those models. Indicated prices are for gas heating machines.

IPS-DR		IPS-DR120	IPS-DR170-G	IPS-DR200-G
Yükleme kapasitesi / Loading Capacity	Kg	51,1	70,4	82,8
Tambur Hacmi / Drum Volume	lt.	1021	1408	1.656
Net Ölçüler / Net Dimensions	Boy/Width mm	1178	1349	1413
	Derinlik/Dept mm	1725	1679	1892
Kapı Açılış Çapı / Door Opening Diameter	Yükseklik/Height mm	2172	2388	2515
	mm Ø	683	683	683
Sıcaklık Derecesi / Temperature	Min/Max °C	38/88	30/92	38/88
Tambur Motoru / Drum Motor	Kw	0,56	0,56	0,56
Fan Motoru / Fan Motor	Kw	0,75	2,24	2,24
Egzost Akış Miktarı / Exhaust Flow	lt/sn	755	1156	1156
Egzost Çıkışı Çapı / Exhaust Outlet Diameter	Ø mm	254	305	305
Elektrik Bağlantıları / Electric Connections	A	125	YOK	YOK
Elektrik Isıtmalı / 380/415 V 3AC 50 Hz / Electric heating / 380/415 V 3AC 50 Hz	Kw	60	YOK	YOK
Gaz&Buhar Isıtmalı / 220 V 1AC 50 Hz / Gas&Seam Heating / 220 V 1AC 50 Hz	Kcal/saat	68.000	99.500	107.098
Buhar Tüketimi @1,0 bar / Steam Consumption	btu/h	272.000	433.000	433.000
Buhar Girişleri / Steam inlets		3/4"X2	3/4" x2	3/4"
Buhar Dönüş / Steam return		3/4"	1"	
Gaz Girişleri / Gas Inlet	mbar	20-28	20-28	20-28
Net Ağırlık - Brüt Ağırlık / Net weight - Gross weight	Kg.	624	760	820



## YARI ENDÜSTRİYEL TİP ÇAMAŞIR YIKAMA VE KURUTMA MAKİNELERİ SEMI-COMMERCIAL WASHERS AND DRYERS



### IPS-CD 10 KURUTMA MAKİNESİ / DRYERS

- 10 Kg kurutma kapasitesi
- 4 adet kurutma programı
- Program sonu sinyali
- Kolay yükleme ve boşaltma
- Sessiz çalışan egsoz motoru sayesinde enerji tasarrufu (Nemli havanın atılması ile)

- Dryer Capacity: 10 Kg
- 4 drying programs
- Program end signal
- Easy loading and unloading
- Energy saving thanks to silent running exhaust motor (with the removal of moist air)



### IPS-CW 10 YIKAMA MAKİNESİ 78 WASHER

- 10 Kg yıkama kapasitesi
- Paslanmaz tambur, kabin
- İstenildiğinde alt yıkama üst kurutma olmak üzere üst üste kullanılabilir (Stacked Model) IPS-CS10
- 6 adet standart yıkama programı
- Free standing (Montaj gerektirmeyen) makine
- Yüksek sıkma hızı (1200 rpm) - G Kuvveti: 440 rpm
- Önden yüklemeli deterjan haznesi
- Boşaltma pompası

- Washer Capacity: 10 Kg
- Stainless steel drum and cabinet
- Stacked model IPS-CS10 is available for the limited places ( Dryer machine stacked on top of washer machine )
- 6 standart washing programs
- Free standing Machine
- High spin (1200 rpm)
- G Force: 440 rpm
- Frontload Soap hopper
- Drain pump"



---

# ÜTÜLER

.....

INDUSTRIAL  
IRONERS





- Endüstriyel tip, silindirden ısıtmalı, kurutmalı ütüler
- Önden besleme ve alma sayesinde yer tasarrufu sağlar
- 300° ye kadar geniş temas yüzeyi ile hızlı kurutma ve ütöleme
- Elektrikli/Gazlı/Buharlı ısıtma seçenekleri
- Otomatik cooldown fonksiyonu
- Kolay kullanım sağlayan mikro işlemci
- Frekans kontrollü motor
- 320mm çaplı silindirli modellerde buhar ısıtma mevcut değildir.
- 58 Kg/h - 145 Kg arası ütöleme kapasitesi (modele göre değişir)
- Nomex ütöleme bantları
- Opsiyonel Jeton mekanizması
- En mükemmel ütöleme sonuçları için presleme etkisi.

- Industrial cylinder heated drying ironers
- Space saving thanks to front feeding and operation
- Speedy drying and ironing thanks to large contact surface up to 300

Heating options: Electric / Gas / Steam

- Automatic cooldown • Easy-to-operate with microprocessor
- Frequency controlled motor
- Steam heating is not available for 320mm diameter roller models.
- Ironing capacity between 58 Kg/h - 145 Kg/h (changing up to the models)
- NOMEX ironing belts
- Optional coin operated version
- SMARTIRON- technology: maximum productivity, superior ironing results.



## BANTLI, KURUTMALI SİLİNDİR ÜTÜLER / INDUSTRIAL CYLINDER HEATED DRYING IRONERS

## IPS-FCI

Belirtilen fiyatlar elektrik ısıtmalı, standart donanımlı cihazlar için verilmiş olup, diğer opsiyonlar için fiyat alınması gerekmektedir.  
Indicated prices are for electric heating, standart equipped models. It is necessary to ask price for the other options.

IPS-FCI		IPS-FCI-1664/320	IPS-FCI-2080/320	IPS-FCI-1600/500	IPS-FCI-2000/500	IPS-FCI-2600/500	IPS-FCI-3200/500
Çalışma Genişliği Working width	mm	1664	2080	1600	2000	2600	3200
Silindir Çapı / Roller Diameter	mm ø	320	320	502	502	502	502
Net Ağırlık / Net Weight	Kg	435	490	890	1020	1260	1470
Brüt Ağırlık / Gross Weight	Kg	485	560	1090	1230	1480	1740
Elektrik Isıtmalı Electric Heating	kW	24,3	27,9	32,4	37,2	54	64,8
Elektrik Isıtmalı Electric Heating	kW	25	30	30	36	52	66
Buhar Isıtmalı / Steam Heating	Kg/h	-	-	36	49	68	88
Ütöleme Hızı / Ironing Speed	m/d	1-6	1-6	1,5-8	1,5-8	1,5-8	1,5-8
Silindir Motoru & Fan Motoru Roller motor / Fan motor	Kw	0,18/0,095	0,18/0,095	0,37/0,18	0,37/0,18	0,37/2x0,18	0,37/2x0,18
Ütöleme Kap. / Ironing Cap.	Kg/saat/h						
Elektrik Isıtmalı Electric Heating	Kg/saat/h	62	70	65	80	95	120
Buhar Isıtmalı / Steam Heating	Kg/saat/h	-	-	80	95	115	145
Gaz Isıtmalı / Gas Heating	Kg/saat/h	58	72	65	80	95	120



- Silindir çapı 370-800 mm arasında değişir
- Elektrik, gaz ve buhar ısıtma opsiyonları
- Digital sıcaklık kontrol ve gösterge

- Roller diameter between 370-800 mm,
- Heating options: Electric / Gas / Steam,
- Digital temperature control and display

#### YATAKTAN ISITMALI SİLİNDİR ÜTÜLER / INDUSTRIAL CHEST HEATED IRONERS

IPS-ACL

Belirtilen fiyatlar elektrikli ve standart modeller için verilmiştir. / Indicated prices are for electric heating and standart equipped models.

	IPS-ACL500	IPS-ACL600	IPS-ACL800
Silindir Çapı (mm) Roller Diameter	500	600	800
Silindir Boyu (mm) Roller Width	1750	1750	2500
Silindir Adedi Number of Rollers	1	1	1
Ütüleme Hızı (m/dk) Ironing Speed	1.5-5.5	1.5-6.5	3-12
Voltaj / Voltage	380-415/50/60/3	380-415/50/60/3	380-415/50/60/3

\* Tabloda belirtilen ürünler elektrik ısıtmalı olup gaz ısıtmalı modeller için fiyat isteyiniz.

\*\* Tabloda belirtilen silindir boyları standart olup 2000, 2200, 2500, 3000, 3300, 3500 mm gibi boy opsiyonları için fiyat isteyiniz.  
Indicated products are electric heating models. It is necessary to ask price for the gas heating models.

\*\* Roller widths indicated on table are standard. It is necessary to ask price for 2000, 2200, 2500, 3000, 3300, 3500 mm width options.



- Tek hat , 2 boyuna + 3 çapraz katlama + Düşme alanında istifleme
- 3.3 m – 3.5m arası çalışma genişliği
- Hareketli dağıtım tablası
- 7-50 m/dk arası otomatik hız senkronizasyonu
- 5.7 " renkli touch panel
- "Single Lane , 2 length

### KATLAMA MAKİNELERİ / FOLD MACHINES

### IPS-ASVF



Belirtilen fiyatlar 2000 mm çalışma uzunluğuna göre elektrik ve standart donanımlı cihazlar için verilmiştir.  
Indicated prices are for electric heating and standart equipped models with 2000 mm working width.

	IPS-ASVF33
Katlama Hızı / Fold speed ( m/min / m/dk)	7-50
Katalama Alanı Boyu / Folding Space width (mm)	3300
Katlama Özelliği / Type of Fold	Tek hat, 2 boyuna + 3 çapraz katlama, Düşme alanında istifleme, 7-50 m/dk arası otomatik hız senkronizasyon "Single Lane , 2 length folds Working width 3.3 m and 3.5m -Moveable delivery table -Automatic speed synchronisation from 7 to 50 M/ min
Voltaj / Voltage	380-415/50/3



- 1,2, 3 boyuna katlama ya da 1 çapraz katlama ile kombine
- French katlama ve altına istifleme.
- 1100mm – 2.400mm arası çalışma genişliği
- Hız: 34 m/dk.
- Kapasite : 1200 havlu/saat
- 1,2 or 3 lateral folds or a French fold combined with 1 cross fold and stacking. Cross fold is combined stacking by Stack & Fold.
- Working width 1100mm, maximum length 2400mm
- Fixed speed: 34 M/min • Capacity: 1200 towel/hour
- PLC touch screen control
- 380-420 v/50hz/60hz/3ph, CE approval



IPS-ATFV3



IPS-ATFVMF

### HAVLU KATLAMA MAKİNELERİ / TOWEL FOLDING MACHINES

### IPS-ATFV

Belirtilen fiyatlar 2000 mm çalışma uzunluğuna göre elektrik ve standart donanımlı cihazlar için verilmiştir.  
Indicated prices are for electric heating and standart equipped models with 2000 mm working width.

	IPS-ATFV3	IPS-ATFVMF
Katlama Hızı / Fold speed ( m/min / m/dk)	34	52
Parça Boyu Max. (mm) / Max folded piece length (mm)	2400	1800
Katalama Alanı Boyu / Folding Space width (mm)	1100	1000
Katlama Özelliği / Type of Fold	3 boyuna ve 1 çapraz katlama 3 lateral folds and 1 French fold	3 boyuna ve 1 çapraz katlama 3 lateral folds and 1 French fold
Ayrıştırma / Type of Sorting	-	Otomatik ( 3 tip havluya kadar) Autmatic ( 3 type towel)
Voltaj / Voltage	380-415/50/3	380-415/50/3



Ø20 / Ø25 / Ø30 için / for Ø20 / Ø25 / Ø30

Genel Özellikler / General Specifications

- Dar alanlarda kullanılmak üzere yapılmış kompakt dizayn
- Compact design
- Elektrik ısı kontrolü
- Electric temperature control



#### DUVAR TİPİ KOMPAKT DİZAYN SİLİNDİR ÜTÜLER / WALL TYPE COMPACT DESIGN DRYING IRONS

**GMP**

Belirtilen fiyatlar elektrikli üniteler için geçerli olup, aşağıdaki modellerin gazlı versiyonu bulunmamaktadır.  
Indicated prices are for electric heating models. There are no gas heated models available in this serie.

GMP		GMP-1000	GMP-1200	GMP 100-25	GMP-120-25	GMP-1600-A	GMP-2000 A
Silindir Boyu (mm) Roller Width	mm	1000	1200	1000	1200	1600	2000
Silindir Çapı (mm) Roller Diameter	mm ø	200	200	250	250	300	300
Ütüleme Hızı (m/dk) Ironing Speed	m/min/ dk	3,3	3,3	3,8	3,8	2,7-4,3	2,4-4,3
Kapasitesi (% 25 nem) Capacity / (% 25 moisture )	Kg/h	20	25	25	30	50	60
Elektrik Isıtmalı / Electric Heating 380/415 V 3AC 50 Hz	Kg/saat/h/Kw	4,6	5,6	6	6,9	11,4	15
Toplam Elektrik Gücü / Total electric power	Kw	4,68	5,68	6,18	7,08	12,5	16,1
Egzost Fanı / Exhaust Fan	m <sup>3</sup> /saat/h	-	-	-	-	80	80
Egzost Bacası / Exhaust chimney	mm ø	-	-	-	-	ø 75 x 55	ø 75 x 55
Ölçüler / Dimensions	Boy/Width mm	1305	1505	1440	1640	2090	2490
	Derinlik/Dept mm	420	420	420	420	552	552
	Yükseklik/Height mm	933	933	1003	1003	1073	1073
Net Ağırlık / Net Weight	Kg.	74	80,5	94	100	221	243
Brüt Ağırlık / Gross Weight	Kg.	85,5	93	119	124	245	271



Ø20 / Ø35 için / for Ø20 / Ø35

Genel Özellikler / General Specifications

- 20 Kg/h-60 Kg/h ütöleme kapasitesi (rh %40-50 arası)
- Ayarlanabilir ütöleme hızı
- Krom kaplanmış silindir
- Otomatik cool-down özelliği
- Gazlı maddelerde titanyum çelir brülör kullanılmıřtır.
- CE belgeli

- Ironing capacity: 20 Kg/h-60Kg/h (rh %40-50)
- Frequency controlled variable ironing speed
- Chrome covered roller
- Automatic Cool-Down
- Titanium steel burner gas heated models
- CE Approved



#### DUVAR TİPİ KOMPAKT DİZAYN KURUTMALI - BANTLI SİLİNDİR ÜTÜLER / WALL TYPE COMPACT DESIGN DRYING IRONS

**GMP-G**

Belirtilen fiyatlar elektrik ısıtmalı, standart donanımlı cihazlar için verilmiş olup, diğer opsiyonlar için fiyat alınması gerekmektedir.  
Indicated prices are for electric heating, standart equipped models. It is necessary to ask price for the other options.

GMP-G		GMP-G 1835	GMP-G 2135
Silindir Çapı (mm) / Roller Diameter	mm	ø 325/1800	ø 325/2100
Ütöleme Kapasitesi (% 25 nem) Capacity / (%25 moisture)	Kg/Saat/h	50	56
Ütöleme Hızı (m/dk) Ironing Speed	m/d	1.6-5	1.6-5
Elektrik Isıtmalı / Electric Heating 380/415 V 3AC 50 Hz	Kw	20.7	23.4
Silindir Motoru & Fan Motoru Roller Motor / Fan Motor	Kw	1	1
Gaz Bağlantısı / Gas Connection	ø	1/2"	1/2"
Egsozt Çapı / Exhaust Diameter	mm	ø 75	ø 75
Hava Atışı / A / Fumes Exrtacti-	m <sup>3</sup> /saat/ h	300	300
Gaz Tüketimi / Gas Consumption	kcal/saat / h	21.402	11.003
Ölçüler / Dimensions	Boy/Width mm	2340	2640
	Derinlik/Dept mm	550	550
	Yükseklik/Height mm	1100	1100
Brüt Ağırlık / Gross Weight	Kg.	520	580

---

# KURU TEMİZLEME MAKİNELERİ

.....

DRY CLEANING MACHINES



## SOVRANA

- Kapalı devre kuru temizleme makinaları enerji, su ve solvent tüketiminde önemli tasarruflar sağlarken, solventlerin yarattığı çevre kirliliğini asgariye indirir. Bununla birlikte farklı filtre ve çevre dostu hydroclean temizleme gibi seçenekleri ile çeşitli modellerde geniş bir seçenek sunar.
  - 2 adet self-cleaning tank, tanktan tanka otomatik solvent transferi
  - Sürekli damıtma, yeni jenerasyon hızlı kurutma
  - Elektrik veya buhar ısıtmalı
  - Pulsar 20 Mikroproses kontrol, programlanabilen 20 adet özel program, otomatik bakım programları
  - Büyük soğutma ünitesi ve çifte geniş hava filtresi
  - Geniş yükleme kapısı ve sessiz operasyon
- Closed circuit dry cleaning machines with heat pump provide energy, water, solvent saving and minimize the environment pollutions by solvents. On the other hand with the selections of different filter and environment friendly hydroclean options present various selections.
  - 2 self-cleaning tank , Automatic solvent transfer,
  - Continue or Temporary Distillation ,Automatic Button Trap Drying, Electric or steam heating versions
  - Microprocessor Computer ,
  - Large loading door , Double lint filter, Large ventilation fan
  - Main safety switch

**SOV**

### KURU TEMİZLEME MAKİNALARI / DRY-CLEANING MACHINES

Aşağıda fiyatları verilen cihazlar standart donanımlı olup, 1 Nylon ekolojik filtre + 1 Deco filtre fiyatlara dahildir. Makinalar elektrik ısıtmalıdır. Diğer opsiyonlar için fiyat istenmesi gerekmektedir. / Below mentioned machines are standard equipped. 1 Nylon ecological filter + 1 Deco filter is included in the prices. The machines are electrically heated. Pls ask price for the other options .

SOVRANA		SOV-10 LT2	SOV-A 40-L	SOV-A 50-L	SOV-15 LT2
Yükleme Kapasitesi / Loading Capacity	Kg/Sefer/ Cyle	10	18	20	15
Silindir Hacmi / Roller Volume	dm <sup>3</sup>	200	340	400	285
Kapı Açılış Çapı / Door Opening	mm ø	350	500	500	500
Tank1	lt	75	110	160	105
Tank2	lt	75	110	160	105
Tank3	lt	-	200	200	-
Damıtma Kapasitesi / Distillation Capacity	lt	100	230	325	164
Ekolojik Filtre Kapasitesi Ecological Filter Capacity	lt	35	55	75	35
Renk Ayrıştırıcı Filtre Kapasitesi Color Sperator Filter Capacity	lt	13	25	25	13
Elektrik Bağlantıları / Electric Connection	Kw	14	21	28,5	16
Buhar Gücü / Steam Power	Kw	4,5	7	9,5	4,5
Su Bağlantıları / Water Connection	ø	3/4"	3/4"	3/4"	3/4"
Buhar Bağlantıları / Steam Connection	ø	1/2"	1/2"	1/2"	1/2"
Net Ağırlık / Net Weight	Kg	1090	1595	1980	1220
Solventli Ağırlık / Weight with Solvent	Kg	1442	2484	3132	1668
Dinamik Sarj / Dynamic Charge	Kg / m <sup>2</sup>	970	1039	1071	1045
Ölçüler / Dimensions	Boy/Width mm	1574	2000	2140	1684
	Derinlik/Dept mm	1440	1550	1740	1505
	Yükseklik/Height mm	2045	2195	2285	2065

\*FİYAT İÇİN BİZE ULAŞIN

# SOVRANA

- Kapalı devre kuru temizleme makinaları enerji, su ve solvent tüketiminde önemli tasarruflar sağlarken, solventlerin yarattığı çevre kirliliğini asgariye indirir. Bununla birlikte farklı filtre ve çevre dostu hydroclean temizleme gibi seçenekleri ile çeşitli modellerde geniş bir seçenek sunar.
- 2 adet self-cleaning tank, tanktan tanka otomatik solvent transferi
- Sürekli damıtma, yeni jenerasyon hızlı kurutma
- Elektrik veya buhar ısıtmalı
- Pulsar 20 Mikroproses kontrol, programlanabilen 20 adet özel program, otomatik bakım programları
- Büyük soğutma ünitesi ve çifte geniş hava filtresi
- Geniş yükleme kapısı ve sessiz operasyon
- Closed circuit dry cleaning machines with heat pump provide energy, water, solvent saving and minimize the environment pollutions by solvents. On the other hand with the selections of different filter and environment friendly hydroclean options present various selections.
- 2 self-cleaning tank , Automatic solvent transfer,
- Continue or Temporary Distillation ,Automatic Button Trap Drying, Electric or steam heating versions
- Microprocessor Computer ,
- Large loading door, Double lint filter, Large ventilation fan
- Main safety switch

**SOV**

## KURU TEMİZLEME MAKİNALARI / DRY-CLEANING MACHINES

Aşağıda fiyatları verilen cihazlar standart donanımlı olup, 1 Nylon ekolojik filtre + 1 Deco filtre fiyatlara dahildir. Makinalar elektrik ısıtmalıdır. Diğer opsiyonlar için fiyat istenmesi gerekmektedir. / Below mentioned machines are standard equipped. 1 Nylon ecological filter + 1 Deco filter is included in the prices. The machines are electrically heated.

Pls ask price for the other options .

SOVRANA		SOV-10 ST2	SOV-15 ST2
Yükleme Kapasitesi / Loading Capacity	Kg/Sefer / Cycle	10	15
Silindir Hacmi / Roller Volume	dm <sup>3</sup>	200	285
Kapı Açılış Çapı / Door Opening	mm ø	350	500
Tank1	lt	75	105
Tank2	lt	75	105
Tank3	lt	-	-
Damıtma Kapasitesi / Distillation Capacity	lt	100	164
Ekolojik Filtre Kapasitesi Ecological Filter Capacity	lt	35	35
Renk Ayırıştırıcı Filtre Kapasitesi Color Sperator Filter Capacity	lt	13	13
Elektrik Bağlantıları / Electric Connection	Kw	14	16
Buhar Gücü / Steam Power	Kw	4,5	4,5
Min. Su Basıncı / Min. Water Pressure	Kg / cm <sup>2</sup>	3,5	3,5
Max. Su Basıncı / Max. Water Pressure	Kg / cm <sup>2</sup>	10	10
Buhar Basıncı / Steam Pressure	Kg / cm <sup>2</sup>	4,5	4,5
Su Bağlantıları / Water Connection	ø	3/4"	3/4"
Buhar Bağlantıları / Steam Connection	ø	1/2"	1/2"
Net Ağırlık / Net Weight	Kg	980	1195
Solventli Ağırlık / Weight with Solvent	Kg	1332	1643
Dinamik Şarj / Dynamic Charge	Kg / m <sup>2</sup>	1095	1065
Ölçüler / Dimensions	Boy/Width mm	994	1094
	Derinlik/Dept mm	1950	2195
	Yükseklik/Height mm	2045	2170

\*FİYAT İÇİN BİZE ULAŞIN



---

# HİJYEN MEDİKAL

.....

HYGIENE / MEDICAL





INT-FR0344



INT-FR0343

**AŞI VE İLAÇ BUZDOLAPLARI  
VACCINE AND DRUG REFRIGERATORS**

MODEL	İÇ SICAKLIK INTERNAL TEMPERATURE	HACİM VOLUME	GÜÇ POWER	ÖLÇÜLER DIMENSIONS	AĞIRLIK WEIGHT
	°C	Lt.	KW	mm	Kg.
INT-FR0344	0 / +10	700	0,3	700*800*2000	140
INT-FR0342	-10 / -30	700	0,4	700*800*2000	140
INT-FR0345	0 / +10	1400	0,75	1400*800*2000	190
INT-FR0343	-10 / -30	1400	1,3	1400*800*2000	200



INT-FR0346

**MEDİKAL BUZDOLABI - 400 LT.  
MEDICAL REFRIGERATOR 400 LT.**

MODEL	İÇ SICAKLIK INTERNAL TEMPERATURE	HACİM VOLUME	GÜÇ POWER	ÖLÇÜLER DIMENSIONS	AĞIRLIK WEIGHT
	°C	Lt.	KW	mm	Kg.
INT-FR0346	0 / +10	400	0,4	600*600*1880	75



INT-FR0364



INT-FR0365

**MEDİKAL BUZDOLAPLARI - 100 LT.  
MEDICAL REFRIGERATORS 100 LT.**

MODEL	İÇ SICAKLIK INTERNAL TEMPERATURE	HACİM VOLUME	GÜÇ POWER	ÖLÇÜLER DIMENSIONS	AĞIRLIK WEIGHT
	°C	Lt.	KW	mm	Kg.
INT-FR0364	-2 / +8	100	0,21	600*600*845	50
INT-FR0363	-10 / -25	100	0,27	600*600*845	65
INT-FR0365	-2 / +8	100	0,21	600*600*845	50



**YERE MONTE TURNİKELİ EL DEZENFEKTANI  
FLOOR MOUNTED HAND DISINFECTION UNIT  
WITH TURNSTILE**

**INT-BJ0031**

MODEL	ÖLÇÜLER / DIMENSIONS	ENERJİ / ENERGY	SU GİRİŞİ WATER INLET	AĞIRLIK WEIGHT
	mm	V		Kg.
INT-BJ0031	660*777*1350	220-230V. 50-60 Hz.	***	37



**ÇİFT TURNİKELİ EL DEZENFEKTANI  
HAND DISINFECTION UNIT WITH DOUBLE TURNSTILE**

**INT-BJ0032**

MODEL	ÖLÇÜLER / DIMENSIONS	ENERJİ / ENERGY	SU GİRİŞİ WATER INLET	AĞIRLIK WEIGHT
	mm	V		Kg.
INT-BJ0032	660*1645*1250	220-230V. 50-60 Hz.	***	79



**TURNİKELİ EL DEZENFEKTAN HATTI  
HAND DISINFECTION UNIT WITH TURNSTILE**

**INT-BJ0019**

MODEL	ÖLÇÜLER / DIMENSIONS	ENERJİ / ENERGY	SU GİRİŞİ WATER INLET	AĞIRLIK WEIGHT
	mm	V		Kg.
INT-BJ0019	865*1100*1600	220-230V. 50-60 Hz.	***	90



**EVVELİ TURNİKELİ EL VE AYAK DEZENFEKTAN HATTI  
HAND AND FOOT DISINFECTION UNIT WITH  
TURNSTILE AND WASHBASIN**

**INT-BJ0021**

MODEL	ÖLÇÜLER / DIMENSIONS	ENERJİ / ENERGY	SU GİRİŞİ WATER INLET	AĞIRLIK WEIGHT
	mm	V		Kg.
INT-BJ0021	1900*1100*1600	220-230V. 50-60 Hz.	1/2"	190



**TURNİKELİ EL VE AYAK DEZENFEKTAN HATTI**  
HAND AND FOOT DISINFECTION UNIT WITH TURNSTILE

**INT-BJ0020**

MODEL	ÖLÇÜLER / DIMENSIONS	ENERJİ / ENERGY	SU GİRİŞİ WATER INLET	AĞIRLIK WEIGHT
	mm	V		Kg.
INT-BJ0020	1900*1100*1600	220-230V. 50-60 Hz.	***	145



**DİKEY VE YATAY FIRÇALI EL VE AYAK DEZENFEKTAN HATTI**  
HAND AND FOOT DISINFECTION UNIT WITH VERTICAL AND HORIZONTAL BRUSH

**INT-BJ0023**

MODEL	ÖLÇÜLER / DIMENSIONS	ENERJİ / ENERGY	SU GİRİŞİ WATER INLET	AĞIRLIK WEIGHT
	mm	V		Kg.
INT-BJ0023	1900*1100*1700	380-400V. 50-60 Hz.	***	215



**EVYELİ YATAY FIRÇALI EL VE AYAK DEZENFEKTAN HATTI**  
HAND AND FOOT DISINFECTION UNIT WITH WASHBASIN AND HORIZONTAL BRUSH

**INT-BJ0022**

MODEL	ÖLÇÜLER / DIMENSIONS	ENERJİ / ENERGY	SU GİRİŞİ WATER INLET	AĞIRLIK WEIGHT
	mm	V		Kg.
INT-BJ0022	1900*1100*1700	380-400V. 50-60 Hz.	1/2"	225



**DİKEY VE YATAY FIRÇALI EVYELİ DEZENFEKTAN HATTI**  
DISINFECTION UNIT WITH WASHBASIN , VERTICAL AND HORIZONTAL BRUSH

**INT-BJ0024**

MODEL	ÖLÇÜLER / DIMENSIONS	ENERJİ / ENERGY	SU GİRİŞİ WATER INLET	AĞIRLIK WEIGHT
	mm	V		Kg.
INT-BJ0024	2400*1100*1700	380-400V. 50-60 Hz.	1/2"	285

**INT-BJ0007**
**DUVARA MONTE TEKLİ EL DEZENFEKTAN HATTI  
WALL MOUNTED SINGLE HAND DISINFECTANT UNIT**

MODEL	MODEL ADI / NAME	ÖLÇÜLER / DIMENSIONS	ENERJİ ENERGY	SU GİRİŞİ WATER INLET	AĞIRLIK WEIGHT
		mm	V		Kg.
INT-BJ0007	Duvara Monte Tekli EL Dezenfektan Hattı	285*190*450	220-230V. 50-60 Hz.	***	7

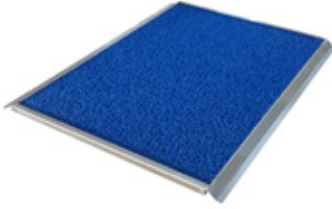
**INT-BJ0029**
**HİJYENİK PASPAS / HYGIENIC MAT**

MODEL	MODEL ADI / NAME	ÖLÇÜLER / DIMENSIONS	ENERJİ ENERGY	SU GİRİŞİ WATER INLET	AĞIRLIK WEIGHT
		mm	V		Kg.
INT-BJ0029	60*90 cm. Rampalı/With Ramp.	600*900*20	***	***	7

**INT-BJ0028**
**HİJYENİK PASPAS / HYGIENIC MAT**

MODEL	MODEL ADI / NAME	ÖLÇÜLER / DIMENSIONS	ENERJİ ENERGY	SU GİRİŞİ WATER INLET	AĞIRLIK WEIGHT
		mm	V		Kg.
INT-BJ0028	60*90 cm. Rampasız/Without Ramp.	600*900*20	***	***	7

**INT-BJ0003**
**GALOŞ BONE MASKE DOLABI / OVERSHOE, BONE, MASK CABINET**

MODEL	MODEL ADI / NAME	ÖLÇÜLER / DIMENSIONS	ENERJİ ENERGY	SU GİRİŞİ WATER INLET	AĞIRLIK WEIGHT
		mm	V		Kg.
INT-BJ0003	Çöp Kutulu/ With Trash Bin	500*221*400	***	***	9



## İLETİŞİM BİLGİLERİ / CONTACT INFORMATION



## • SATIŞ - PAZARLAMA / SALES AND MARKETING

Küçük Piyale Mah. Ağaçköprü Sokak. No:28 Kastel  
İş Merkezi C Blok Kat:4 Daire: 5  
Kasımpaşa / İSTANBUL  
T: +9 0212 – 297 45 04 (5 hat) Fax: +9 0212 – 238 95 48  
istanbulbolge@inoksan.com.tr

## • GENEL MÜDÜRLÜK / REGIONAL DIRECTORATES

Küçük Piyale Mah. Ağaçköprü Sokak. No:28 Kastel İş Merkezi C Blok Kat:4 Daire: 5  
Kasımpaşa / İSTANBUL  
T: +9 0212 – 297 45 04 (5 hat) Fax: +9 0212 – 238 95 48  
istanbulbolge@inoksan.com.tr

## • FABRİKA / FACTORY

İşiktepe OSB Mahallesi, Eflatun Cadde No:5  
16215 Nilüfer / BURSA / TURKEY  
T: +9 0224 294 74 74 Fax: +9 0224 243 61 23  
inoksan@inoksan.com.tr

## • SATIŞ SONRASI HİZMETLER MÜDÜRLÜĞÜ / AFTER SALES SERVICE

İşiktepe OSB Mahallesi, Eflatun Cadde No:5  
16215 Nilüfer / BURSA / TURKEY  
T: +9 0224 294 74 74 Fax: +9 0224 243 36 67

## YETKİLİ SERVİS VE SATIŞ NOKTALARI

## AUTHORIZED SERVICE AND SALES POINTS



Yetkili servis ve satış noktalarımıza [www.inoksan.com](http://www.inoksan.com) adresinden ulaşabilirsiniz.  
You can reach our authorized services and sales point at [www.inoksan.com](http://www.inoksan.com)

## FİYATLARA KDV DAHİL DEĞİLDİR

KDV ve diğer vergi oranlarında olabilecek değişiklikler ve gelebilecek yeni vergiler aynen yansıtılacaktır.

Talepler stok ve üretim olanakları dahilinde teslim edilir.

İNOKSAN fiyatlarda değişiklik yapma hakkını saklı tutar ve basımdan kaynaklanan hatalardan dolayı sorumluluk kabul etmez.

The information and pictures in the list can not be used without İNOKSAN's written permission.

İNOKSAN reserves the right to change specifications and prices without prior notice.

İNOKSAN bears no responsibility for typo-graphical, technological or illustrative errors of products and descriptions in the price list.

Date of publication: January 2019





**iNOKSAN**

# iNOKSAN

**TURQUALITY®**



Çağrı Merkezi  
0850 290 44 00

[www.inoksan.com](http://www.inoksan.com)

[f](#) [inoksan](#) [@](#) [inoksanmutfak](#) [in](#) [company/inoksan](#)